



Table of Contents

Introduction

Terms and Conditions	2
General Specifications	5
Materials & Finish Palette	7

Highline Conference Tables

Table Specifications	14
42"/48" Rectangular Conference Tables	20
54" Rectangular Conference Tables	26
60" Rectangular Conference Tables	32
72" Rectangular Conference Tables	38
Elliptical Conference Tables	44
Boat Conference Tables	50
Trapezoid Conference Tables	56

Highline Meeting Tables

Table Specifications	62
Meeting Tables	66

Highline Credenzas

Credenza Specifications	72
Credenzas	78

Highline Fifty Conference Tables

Table Specifications	86
48" Rectangular Conference Tables	92
54" Rectangular Conference Tables	98
60" Rectangular Conference Tables	104
72" Rectangular Conference Tables	110
48"-72" Boat Conference Tables	116

Highline Fifty Meeting Tables

Table Specifications	124
Meeting Tables	130

Highline Fifty Credenzas

Credenza Specifications	136
Credenzas	142

Highline Twenty-Five Credenzas

Credenza Specifications	148
Credenzas	154

Highline Vector Conference Tables

Table Specifications	160
42", 48" & 54" Conference Tables	164
60" Conference Tables	190
72" Conference Tables	200

Accessories

Power & Connectivity	211
----------------------	-----

Terms and Conditions of Sale

Sales by DatesWeiser (hereinafter called the Seller) are made only on the terms and conditions set forth below. These terms and conditions may be modified or supplemented only by a written document signed by an authorized representative of the Seller. These terms and conditions supersede any prior and/or contemporaneous agreements or correspondence between Purchaser and Seller.

Ordering Information

All orders must be in writing.

A Purchase Order is not binding on the Seller until Purchaser has received Seller's Order Confirmation.

Pricing Policies

All written quotations expire thirty (30) days from the date of issuance and can be withdrawn by written notice anytime during that period.

Prices are List, F.O.B. from the DatesWeiser factory in Buffalo, New York. Shipping, packaging, inside delivery, uncrating, installation, storage, and sales tax (if applicable) shall be in addition to the list price and shall be itemized and charged separately.

List prices are subject to change without notice.

List prices shall be those prices in effect on the date the Seller receives a completed Purchase Order unless shipment is requested more than 120 days after the order entry, in which case prices in effect on the date of shipment apply.

Taxes

All sales, use, excise, and other taxes applicable to the sale of DatesWeiser Products shall be paid by the Purchaser. To claim an exemption from any tax, Purchaser must submit to Seller the appropriate exemption certificates.

Terms of Payment

A fifty percent (50%) deposit is due at the time of order placement and the remainder due within thirty (30) days of the date of invoice.

If, in the judgment of Seller, Purchaser's financial condition does not justify the terms of the payment, Seller may require full or partial payment in advance.

The ship date the Seller specifies is considered the invoice date for billing. The ship date will be confirmed by the Seller via a separate Acknowledgement issued upon receipt of a signed Purchase Order.

Past due accounts shall be charged one and one-half percent (1.5%) per month, or the highest rate permitted by law, which-ever is less, and will be added to the outstanding balance. In the event Purchaser defaults on payment, Purchaser shall be liable for all collection costs, including reasonable attorney's fees and costs.

Changes and Cancellations

A confirmed order may not be changed or cancelled, in whole or in part, without prior written consent of Seller. Changes may effect delivery dates. Expenses incurred because of changes shall be charged to Purchaser. In event of cancellations, Purchaser will be liable for reasonable cancellation charges, including a \$500 administrative fee.

Seller is not required to comply with Purchaser's request to change a confirmed order, but all reasonable requests to change confirmed orders will be honored. Orders for special or custom Product may not be cancelled.

To be effective, a Change Order must be in writing, signed by the Purchaser or Purchaser's agent, and confirmed in writing by the Seller. Change Orders are subject to a charge for materials, labor, and other costs as determined by Seller.

Security Interest

Until Seller receives the full payment for the Product, Seller shall have a security interest in the Product. Purchaser agrees to perform all acts, including but not limited to the execution and filing of documentation, which may be necessary to perfect and assure the security interest of Seller.

Customer's Own Material (COM)

A Purchaser who requests a material not standard to Seller's line of Products must submit a sample of the requested material to Seller prior to entry of a purchase order. Seller shall determine if the material is suitable to its manufacturing processes and meets any requirements of Underwriter Laboratories. If the COM is acceptable, Seller will then establish a price for using the COM on the Product in question.

Custom Finish Match

For custom wood or paint finishes add \$1,032 net per finish. This is a one-time matching charge. Custom finishes may extend delivery time up to four (4) weeks. Control samples of custom finishes will be provided.

Hardware

Final adjustment of furniture hardware such as hinges, drawer slides, drawer pulls, etc., at the installation and as a punch-list item, if required, is the Purchaser's responsibility.

Design

All Products shown in the Seller's Price List and Specifications Guide are, and remain, the property of the Seller, who reserves the exclusive right to manufacture them. All dimensions shown are to be considered approximate. Seller reserves the right to make changes in price, dimensions, design and/or construction without prior notice.

Shop Drawings

Seller allows for one (1) set of full shop drawings and one (1) round of minor drawing revisions in its pricing and scheduling. Thereafter, any significant changes in design, including dimensions, engineering details, and materials, or delays in reviewing and approving shop drawings, may necessitate additional charges and cause schedule delays. Seller reserves the right to determine the impact of any design changes and/or delays and will promptly notify those involved of any adjustments to cost and schedule.

Field and Hold Dimensions

If a dealer or third party is responsible for providing installation, the following is required: Full responsibility for providing accurate and timely field dimensions or hold to dimensions (in cases where walls are not erected) as it effects the ultimate fit of the installation. As an alternative, upon request, Seller can provide a cost for sending a field technician to the project site to assume responsibility for field dimensions and site evaluation.

Freight and Delivery

Products are carefully inspected and packaged before leaving the factory to ensure they reach their destination in excellent condition. Whenever possible, the Seller will ship in accordance with the Purchaser's instructions. If Purchaser does not specify shipping instructions, Seller will use its best judgment to determine the most suitable shipping method, route, and carrier.

Conditions beyond the control of Seller, including weather, available facilities and traffic conditions, may affect time of delivery.

Storage

If the Purchaser cannot accept delivery per the ship date specified in the Seller's Acknowledgement, the Seller may transfer the merchandise to storage, either at its facility or at another facility.

Purchaser will be charged a storage fee of two percent (2%) of the invoice for every thirty (30) days the products are stored at the Seller's facility.

For products stored in another facility, all out-of-pocket costs of storage, including transportation and warehousing fees, will be at the Purchaser's expense.

The Purchaser will be invoiced for all product charges on the date the Products are transferred to storage. Storage fees will accrue monthly in full month increments (they are not pro-rated for partial months) and will be added to the first invoice, which will also include non-product charges such as shipping, installation, etc.

Returns

Purchasers may not return Products without Seller's written approval and shipping instructions. Unauthorized returns, and returns shipped inconsistently with Seller's instructions, will be automatically refused by the Seller's receiving department.

Products not currently offered for sale by Seller, including special and custom Products, shall not be authorized for return. All returned Products must be unused, in original condition and in original Seller shipping cartons. No refund or credit shall be given for damaged Products.

Claims

All shipments for Sellers Product are F.O.B. Origin. All risk of loss passes to Purchaser at time of delivery to carrier. Purchaser shall inspect all Products upon receipt and note any damage on the Bill of Lading and make an immediate request for inspection of damage by carrier. Seller is not responsible for damage that occurs in transit or storage.

Damage that becomes apparent after the Product is unpacked should be reported to the carrier and the Seller within twenty-four (24) hours of receipt. Damage that is incurred at a furniture dealer's warehouse is the responsibility of the furniture dealer.

For claims relating to Product damaged in transit, or for any other claims relating to or arising out of the transportation of the Product, Purchaser must seek recovery from the carrier. Seller may, upon request, assist Purchaser with filing of such claims with the carrier.

Claims for defects, errors, or shortages must be made in writing by Purchaser against Seller within 72 hours after delivery. Failure to make such claim within 72 hours shall constitute unconditional acceptance of the Products and a waiver of any apparent defects, errors, or shortages.

Warranty

Seller warrants its Products to the original Purchaser to be free of defects in workmanship and materials under normal use and under conditions for which the Product was designed for a period of five years for custom product and 12 years for standard product. This remedy is exclusive. Seller does not authorize any person to create for it any obligation or liability.

During this warranty period, Seller will repair, or at its option, replace, such Product proven to be defective. Seller shall not be liable for commercial loss or any consequential or incidental damages that may arise as a result of defective Product.

This limited warranty does not apply to:

- Damage caused by a carrier other than the Seller.
- Product not properly maintained per Seller instructions. Maintenance and proper environmental conditions are described in Seller's Published Price List. All furniture should be used in a stable, controlled atmosphere and positioned to avoid direct sunlight. Ideal climate is 65 to 75 degrees Fahrenheit with 30 to 55% relative humidity.
- Normal wear and tear or acts or omissions of parties other than Seller. This warranty does not cover any product repaired or altered by any person not so authorized by Seller, including user modification, improper use or installation of Products.
- Customer's Own Material and Customer's Specified Laminates.
- Durability or suitability of any exterior surface coatings or treatments.
- Matching of color, grains or texture except as specified in the Seller's Order Confirmation and the finish sample.
- Natural variations occurring in wood, stone, and glass shall not be considered defects, and the Seller does not guarantee the colorfastness or matching of colors, grains or textures, or surface hardness of such materials.
- Adequacy of any electronic components.
- Durability of glass used in Product.
- Live Edge natural slabs used for table tops.

Seller must be notified within 72 hours of receipt of shipment for any initial claims for defects, errors or shortages.

To obtain the benefit of this warranty, contact Seller in writing. It is the responsibility of the Purchaser to arrange the return of Product to Seller and to assume all costs relating to any incidental or consequential damages.

Disclaimers

THE EXPRESS WARRANTIES CONTAINED IN THIS SELLING POLICY ARE THE ONLY WARRANTIES THAT DATESWEISER MAKES AND TAKE THE PLACE OF ALL OTHER WARRANTIES, EXPRESS OR IMPLIED, INCLUDING ANY WARRANTIES OF MERCHANTABILITY OR FITNESS FOR PARTICULAR PURPOSE AND ALL OTHER WARRANTIES ARISING FROM COURSE OF DEALING OR USAGE OF TRADE.

Corporate Office / Factory

1700 Broadway Street

Buffalo, NY 14212

p 716.891.1700

General Specifications

Note:

Line drawings in this price list are purely for quick product identification without form of detail and cannot be used to satisfy production dimensions, shape or support options. Refer to Planning Guide for detailed product information.

Levelers

All bases are equipped with floor levelers to level the table.

Grommets

Please contact customer service at customerservice@datesweiser.com or your local DatesWeiser representative to request a quote based on your specific needs. To find your local representative, visit

www.datesweiser.com/contacts.

Power & Connectivity

Refer to Accessories Section page 209.

Wood Finishes and Materials

Selecting materials and other features are the first steps to ordering your DatesWeiser furniture. As you move through the steps on the product pages, you will need to fill in the blanks with the codes for the finishes and features you select.

Wood veneers are selected from the finest hardwoods available around the world and top coated with a low-VOC, post-catalyzed finish. The typical sheen is 30%.

Veneers come in two price ranges (Tiers), and described as follows:

1. Cut (Plain-sliced, rift, quartered, engineered)
2. Species (Oak, Walnut, etc.)
3. Finish (Natural, Smoked, Dark, Cerused, etc.)

Quartered, rift-cut and engineered veneers are slip matched except for Black Limba.

Plain-sliced veneers are book matched.

Examples:

1. T124 (Denotes Tier 1 Plain sliced Maple, Natural)
2. T227 (Denotes Tier 2 Quartered Walnut, Natural)

Paint Finishes and Materials

SL__ (Satin Lacquer)

Opaque paint with a 50% typical sheen.

HG__ (High Gloss Polyester) Opaque paint with a hand rubbed high gloss finish.

*Color codes are entered in the blanks.

Metal Finishes and Materials

MC__ Powder Coat

A coating applied electrostatically as a dry powder, then cured under heat to allow it to flow and form a 9skin9. Used to create a hard finish that is more durable than conventional paint.

PM__ Premium Metal Electroplating produces a premium metal finish.

*Color codes entered in the blanks.

Finishing Excellence

DatesWeiser collaborates with leading colorists to develop a palette particularly suited to the executive workplace. This range is available on all our products and coordinates with our extensive veneer offering.

To order finish samples, please contact customer service at customerservice@datesweiser.com or your local DatesWeiser representative. To find your local DatesWeiser representative, visit www.datesweiser.com/contacts.

If you do not see what you want, we are happy to work with you to develop a unique product solution.

Datesweiser printed and veneer samples offer an example of what a typical veneer will look like, within a range of acceptability carefully determined by DatesWeiser. Samples and printed sample materials should be used as reference only.

FSC® Certification:

FSC®-C103565

Responsibility harvested materials certified by the Forest Stewardship® (FSC®-C103565) are available upon request and may increase pricing. Requests for FSC® (License: FSC®-C103565) certified materials or LEED certification must be made before an order is processed.

Product Maintenance

Regular dusting with a soft cloth will help prevent fine dust particles from becoming embedded in the finished surface. We recommend using a soft flannel cloth slightly dampened with water, followed by a dry cloth. Always wipe in the direction of the grain.

CAUTION:

Never use a chemically treated cleaning cloth.

For removing residues, smudges, etc., we recommend using a very mild (non-ammonia) soap and water solution. Apply with a soft flannel cloth followed by a dry cloth. Always wipe in the direction of the grain.

We recommend using felt pads on all objects that come into contact with our furniture. Certain vinyl and rubber products can chemically react with the finish on wood if left in contact for extended periods of time. Coasters, place mats, notebook covers, and rubber or plastic feet (found on most accessories) can also damage wood surfaces. To avoid indentations caused by writing instruments, always use a non-vinyl blotter or writing pad.

All furniture should be used in a stable, controlled atmosphere and positioned to avoid direct sunlight. The ideal climate is 65-75°F with 30-55% relative humidity.

Materials & Finish Pallette

Veneer Finishes come in (2) sheens.

M = 15% Sheen

L = 35% Sheen

Veneer: Tier 1 - Natural



T001 White Quarter Cut Ash



T002 Natural Flat Cut Oak

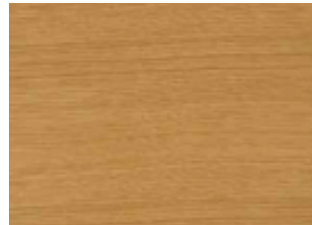

T003 Natural Rift Cut Oak



T004 Natural Flat Cut Walnut



T005 Cashmere Flat Cut Walnut

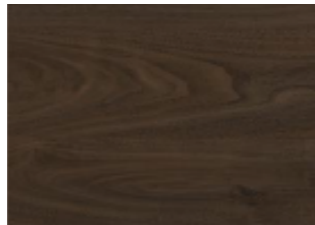

T006 Persian Flat Cut Walnut



T007 Ebonized Flat Cut Ash



T014 Natural Flat Cut Maple



T019 Natural Rift Cut European Oak

Veneer Finishes come in (2) sheens.

M = 15% Sheen

L = 35% Sheen

Veneer: Tier 1 - Engineered



R008 RecoGrain Natural Flat Cut Walnut



R009 RecoGrain Natural Quarter Cut Walnut



R010 RecoGrain Natural Quarter Cut Oak



R011 RecoGrain Frosty Quarter Cut Ash



R012 RecoGrain Natural Quarter Cut Rima Oak

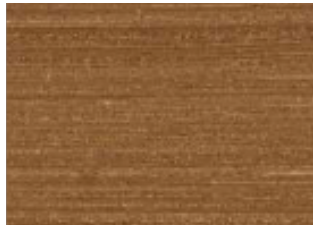

R013 RecoGrain Natural Quarter Cut Rima Walnut



G6T RecoGrain Clear on Ash



G6U RecoGrain Oak on Ash



G6V RecoGrain Walnut on Ash



G637 Techwood Natural Oak



G644 Techwood Light Walnut



G645 Techwood Dove grey Oak

Veneer: Tier 2 - Natural



T015 Natural Quarter Cut Walnut

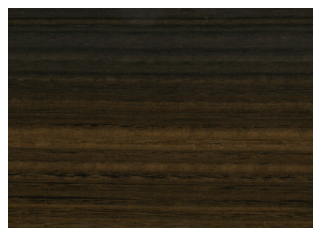

T016 Fumed Quarter Cut Eucalyptus

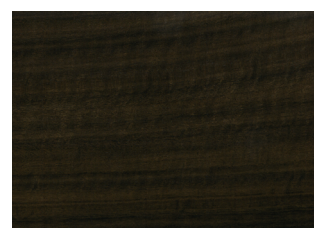

T017 Fumed Quarter Cut Figured Eucalyptus

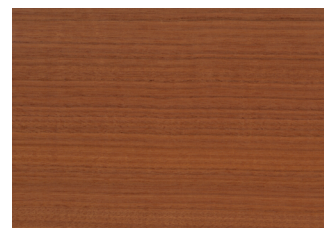

T018 Natural Quarter Cut Makore

Paint: High Gloss Polyester + Satin Lacquer



SL01 White

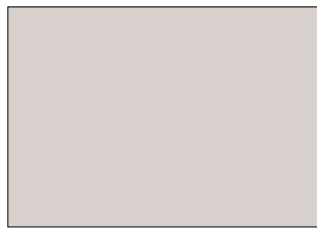

SL02 Light Beige



SL03 Sand



SL04 Taupe

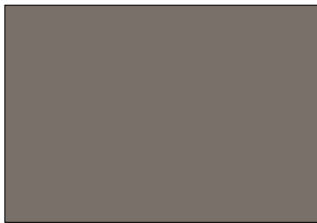

SL05 Light Brown



SL06 Light Grey

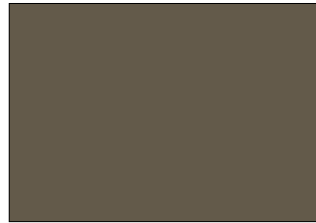

SL07 Quartz Grey



SL08 Umbra Grey



SL09 Black Brown

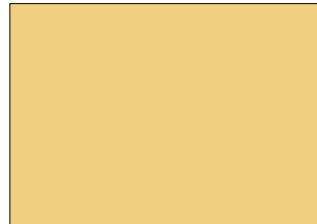

SL10 Yellow Finch

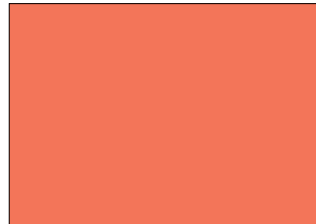

SL11 Jack O Lantern

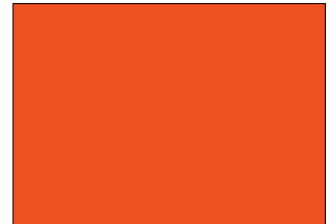

SL12 Racing Orange

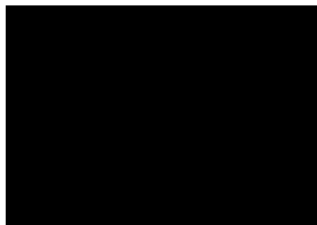

SL13 Jet Black



HG20 / SL20 Red

Metal: Powder Coat



MC01 White



MC02 Light Grey



MC03 Quartz Grey



MC04 Umbra Grey

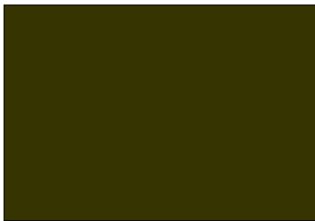

MC05 Black Brown

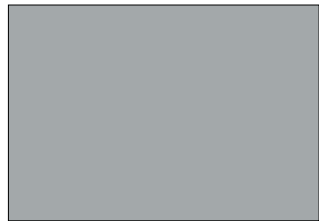

MC06 Silver



MC08 Gunn Powder

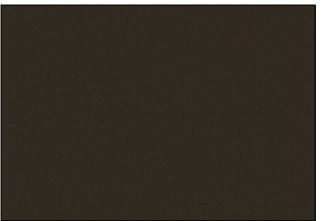

MC09 Bronze

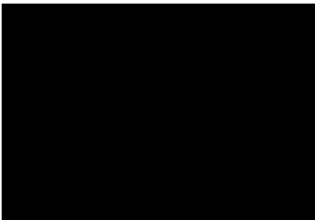

MC11 Jet Black

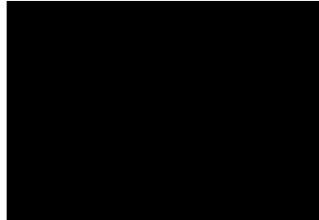

MC12 Black

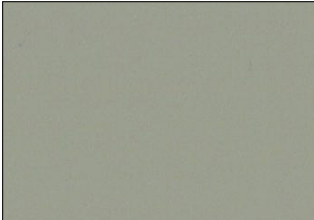

MC13 Warm Grey



MC20 Red

Metal: Premium

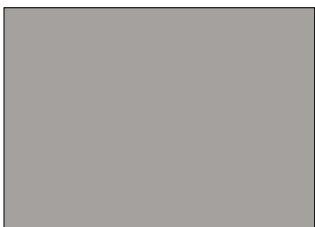

PM01 Polished Chrome



PM02 Satin Nickel

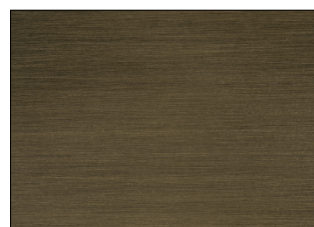

PM03 Oil Rubbed Bronze

Back Painted Glass: Clear + Etched Matte

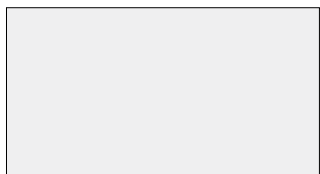

GC01 / GE01 White

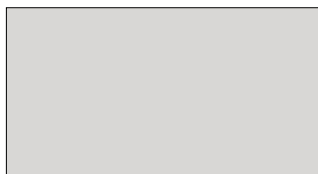

GC24 / GE24 Light Beige



GC21 / GE21 Taupe

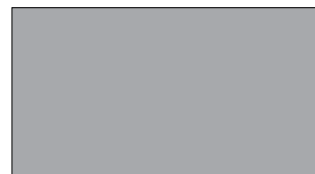

GC23 / GE23 Light Grey



GC02 / GE02 Grey

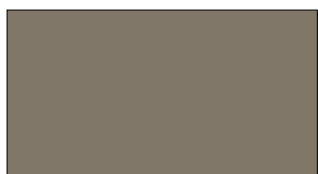

GC22 / GE22 Quartz Grey



GC04 / GE04 Coco



GC03 / GE03 Black



GC20 / GE20 Red



GC00 Clear Glass, no back-paint
Available on credenzas only

Solid Surface: For additional stone options and pricing please contact your sales representative.



CS01 Corian, Glacier White

Leather: Spinneybeck-Acqua



AU 0610 North Sea

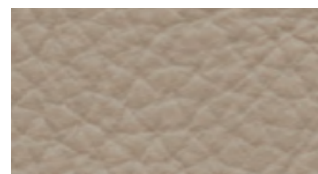

AU 0605 Tahiti

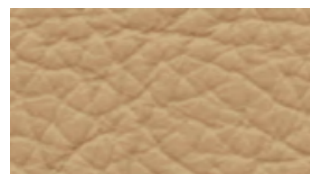

AU 0607 Lake Como

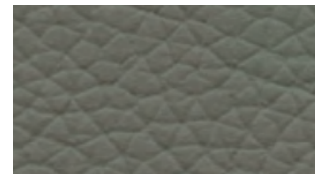

AU 0614 River Thames

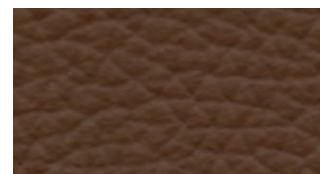

AU 0647 Straits of Gibraltar

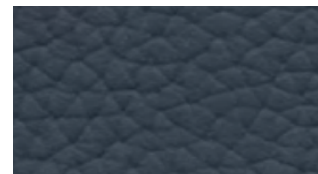

AU 0631 Cantabrian Sea

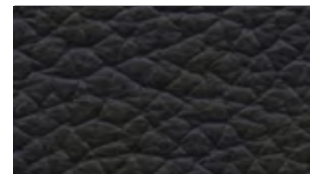

AU 0642 Longship

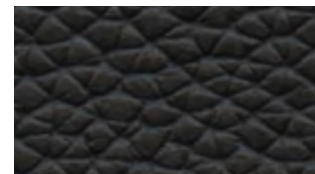

AU 0617 Black Sea

Highline Collection

Highline Conference Tables



DATESWEISER

General Specifications

Highline Conference Tables

Overall Elevations and Clearance

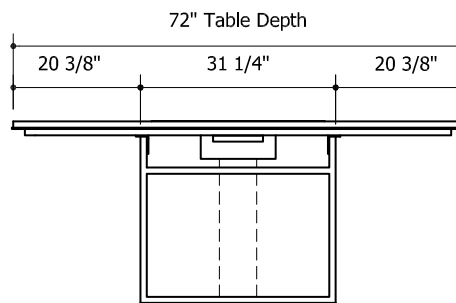
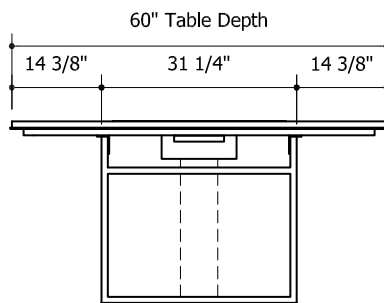
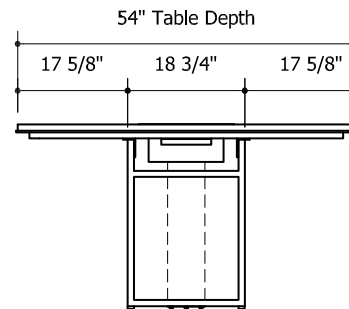
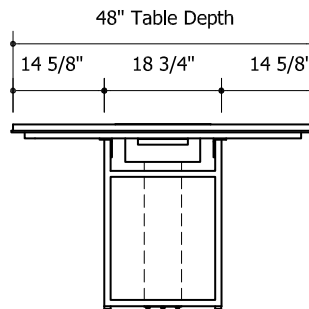
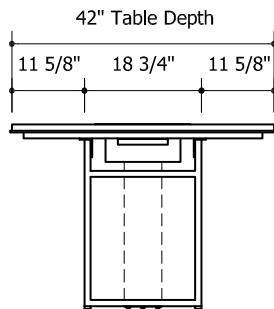
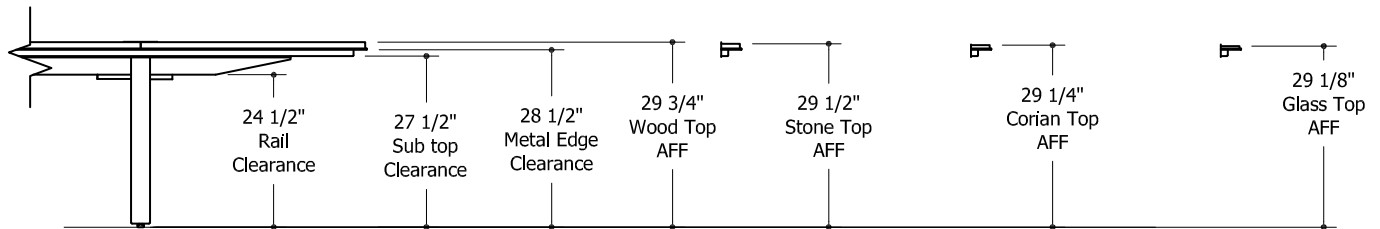

General Specifications

Highline Conference Tables

Top Construction

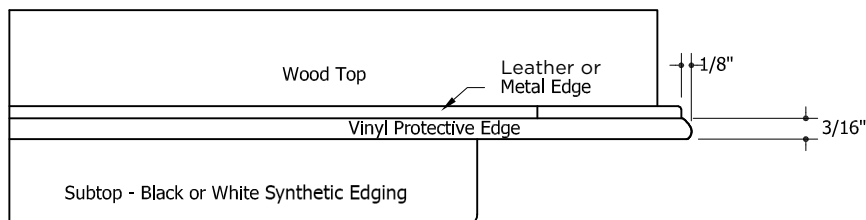
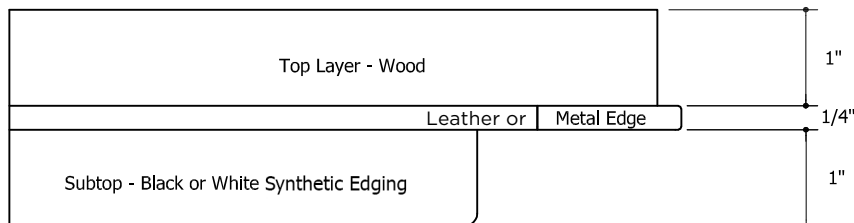
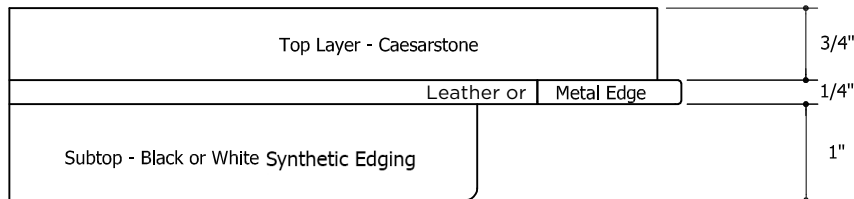
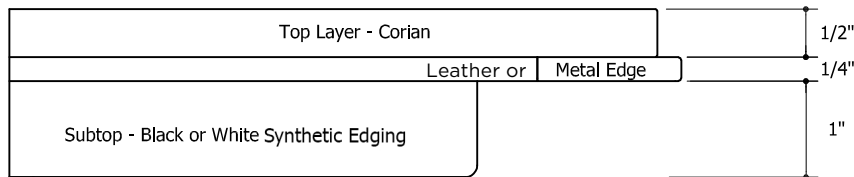
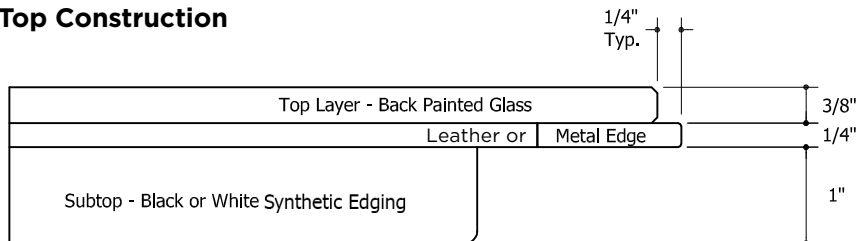

General Specifications

Highline Conference Tables

Base Construction / Wire Management

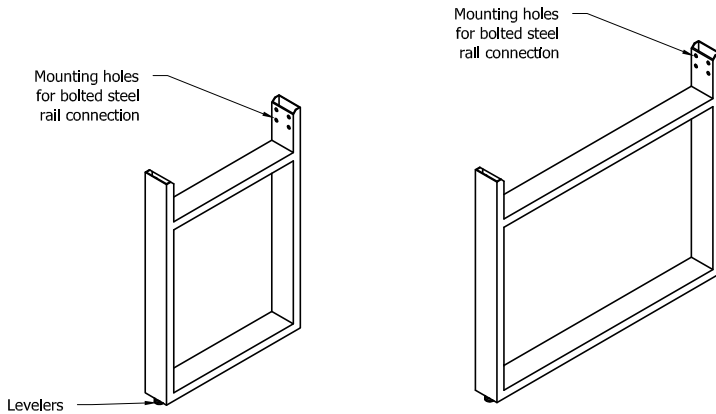

- Highline Small Base**
- Used on 42" / 48" / 54" widths
 - Also used in combination with large bases for some elliptical and trapezoid configurations
 - Construction: 1" x 3" tubular steel

- Highline Large Base**
- Used on 60" / 72" widths
 - Also used in combination with small bases for some elliptical and trapezoid configurations
 - Construction: 1" x 3" tubular steel

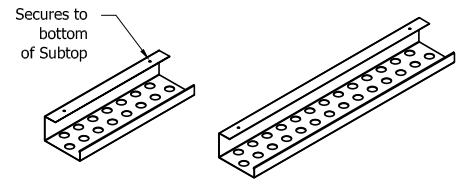

- Wire Manager**
- Length varies by table 16" or 28" x 5" deep x 3" high
 - Construction: Steel with black powder coat metallic finish (MC12)

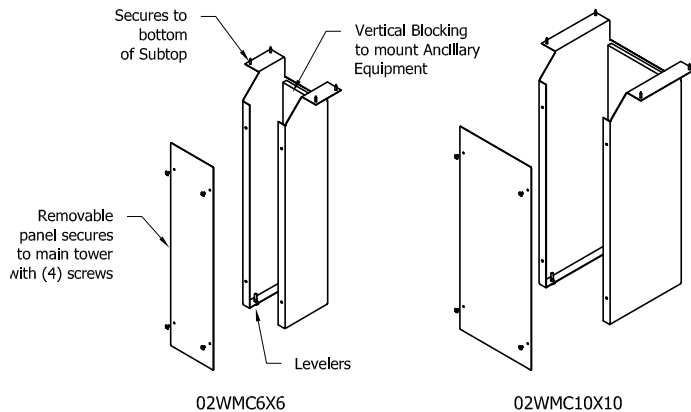

Pattern No.	MC__	PM01/PM02	PM03
02WMC6X6	\$585	\$1,556	\$2,194
02WMC10X10	\$1,064	\$1,649	\$3,736

- Wire Management Column**
- Ordered separately but required with all power options
 - Location is flexible but placement on table centerline is recommended

02WMC6X6 6" x 6" with clear inside of 4" x 5"
 02WMC10X10 10" x 10" with clear inside of 8" x 9"

General Specifications

Highline Conference Tables

Table Top Power / Connectivity Layout

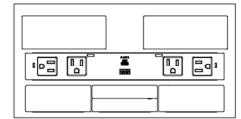
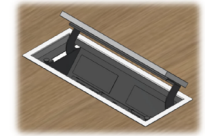
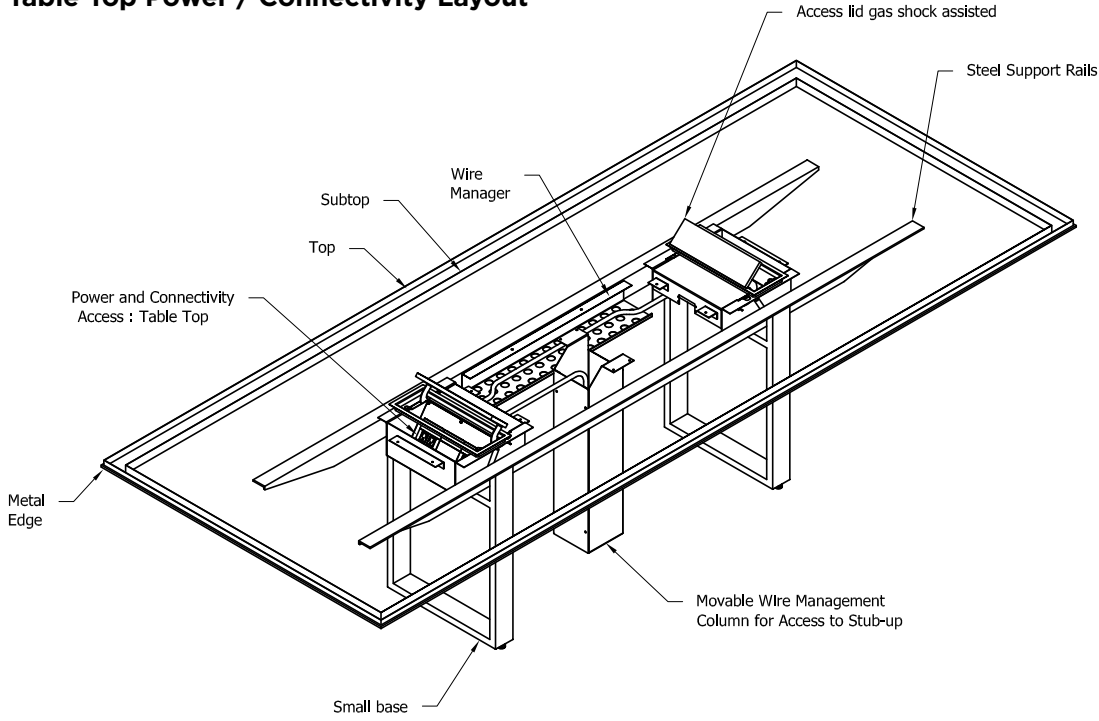

Single-Sided Conference Table Topmount

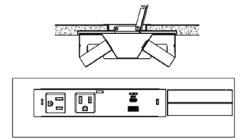
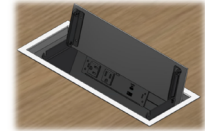

Double-Sided Conference Table Topmount (Both Sides)

Undermount Power / Connectivity Layout

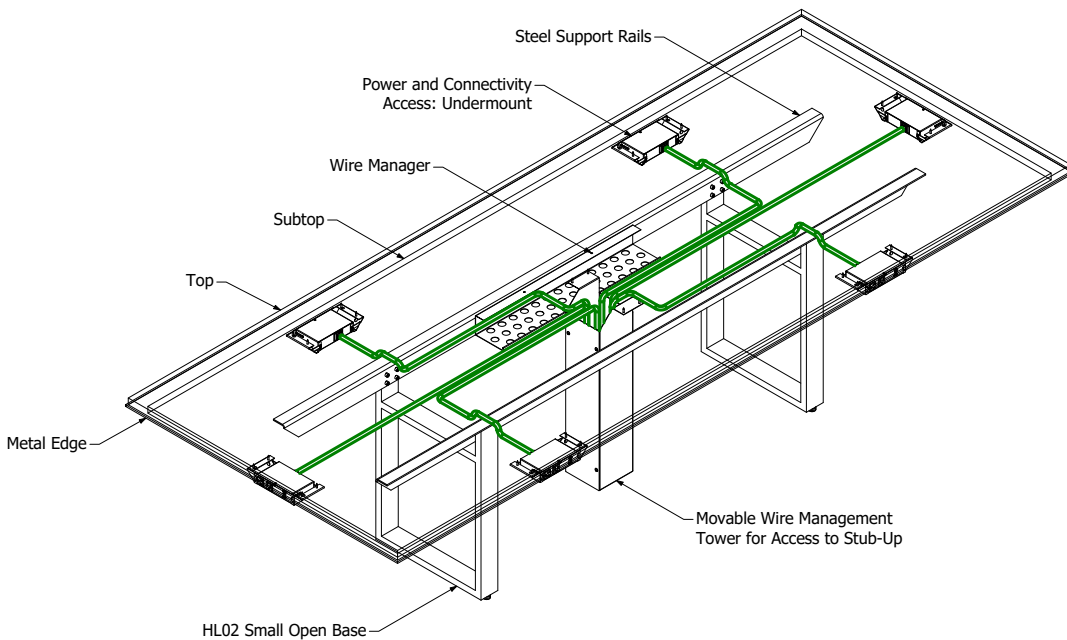

Undermount Power

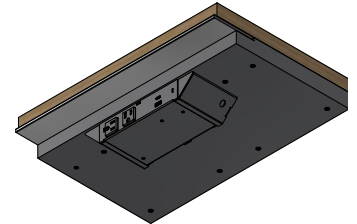

Edgemount Power

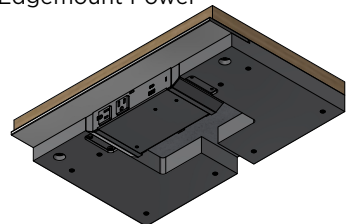

General Specifications

Highline Conference Tables

Undermount Power / Connectivity Layout

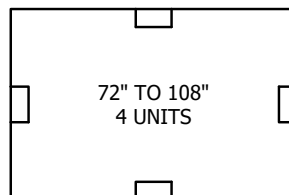
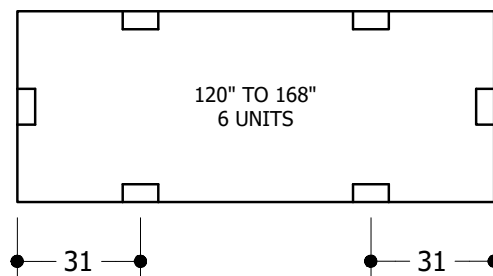
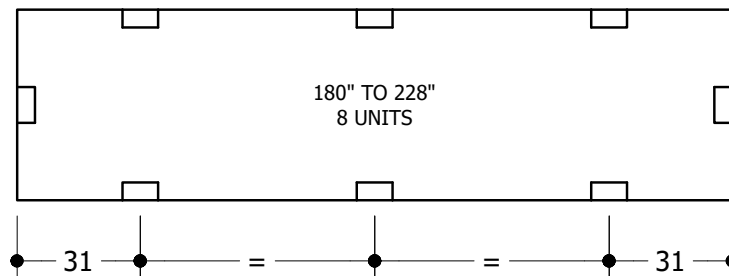
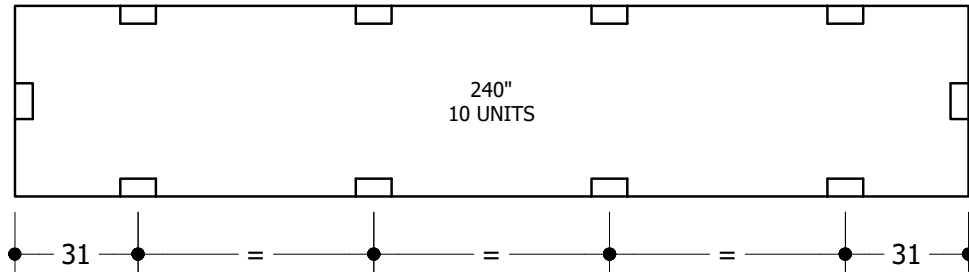

POWER LOCATIONS & QUANTITY BY TABLE LENGTH

Rectangular Conference Tables

42"-48" Deep Tops

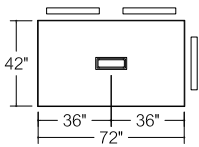
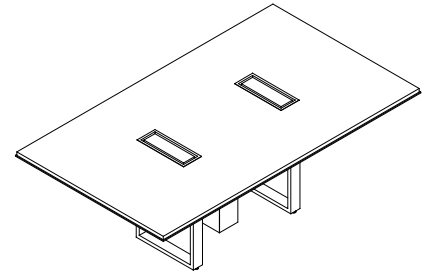

02R42X72
6 Person Table

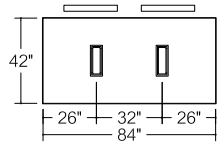

02R42X84
6 Person Table

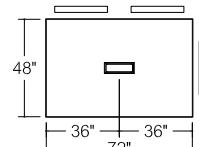

02R48X72
6 Person Table

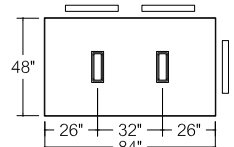

02R48X84
6 Person Table

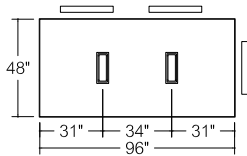

02R48X96
6 - 8 Person Table

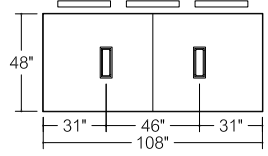

02R48X108
8 Person Table

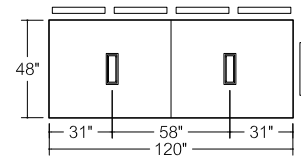

02R48X120
10 Person Table

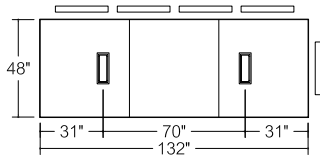

02R48X132
10 Person Table

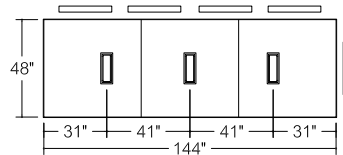

02R48X144
10 Person Table

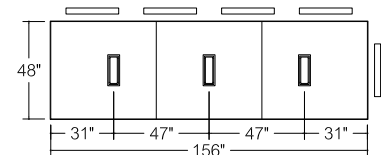

02R48X156
10 - 12 Person Table

Rectangular Conference Tables

42"-48" Deep Tops

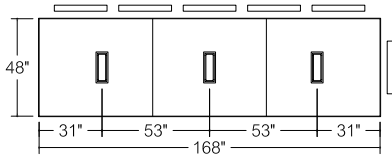
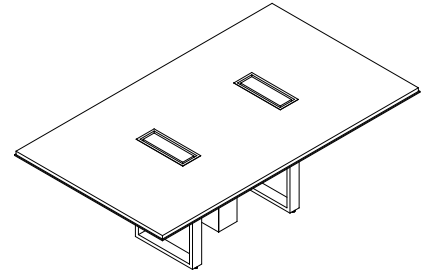

02R48X168
12 Person Table

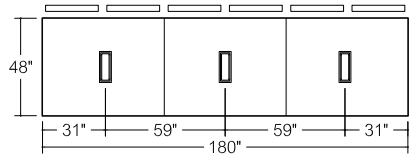

02R48X180
14 Person Table

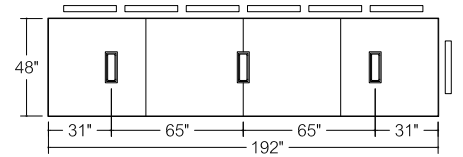

02R48X192
14 Person Table

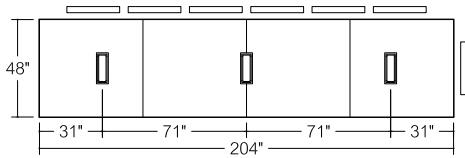

02R48X204
14 Person Table

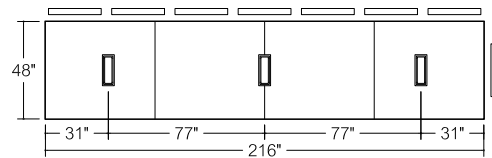

02R48X216
16 Person Table

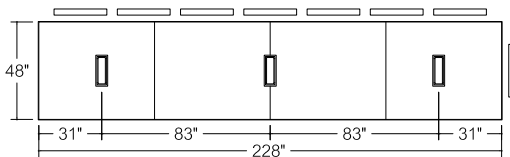

02R48X228
16 Person Table

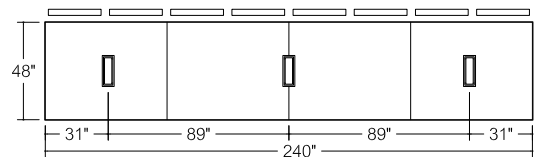

02R48X240
18 Person Table

Rectangular Conference Tables

42"-48" Deep Tops

Veneer Top

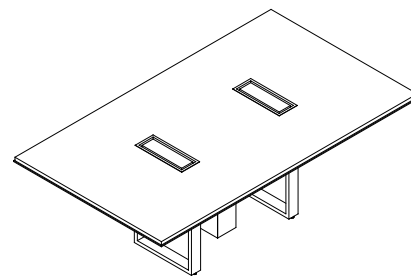

D	W	Pattern No.	T1__ Top	T2__ Top	PM01/ PM02 Edge Upcharge	PM03 Edge Upcharge	AU__ Edge Upcharge	PM01/ PM02 Base Upcharge	PM03 Base Upcharge
42"	72"	02R42X72	\$10,784	\$11,366	\$821	\$821	\$1,967	\$387	\$759
42"	84"	02R42X84	11,551	12,227	973	973	2,173	387	759
48"	72"	02R48X72	11,185	11,849	849	849	2,069	387	759
48"	84"	02R48X84	12,030	12,806	1,323	1,323	2,278	387	759
48"	96"	02R48X96	12,530	13,414	1,323	1,323	2,484	387	759
48"	108"	02R48X108	13,577	14,576	1,323	1,323	2,691	387	759
48"	120"	02R48X120	14,632	15,740	1,379	1,379	2,898	387	759
48"	132"	02R48X132	17,941	19,159	1,380	1,380	3,105	387	759
48"	144"	02R48X144	18,879	20,209	1,379	1,379	3,313	581	1,138
48"	156"	02R48X156	19,606	21,045	1,379	1,379	3,520	581	1,138
48"	168"	02R48X168	20,773	22,322	2,269	2,269	3,727	581	1,138
48"	180"	02R48X180	21,618	22,955	2,269	2,269	3,933	581	1,138
48"	192"	02R48X192	22,534	24,305	2,269	2,269	4,141	581	1,138
48"	204"	02R48X204	23,684	25,566	2,269	2,269	4,348	581	1,138
48"	216"	02R48X216	24,264	26,256	2,269	2,269	4,554	581	1,138
48"	228"	02R48X228	25,111	27,217	2,269	2,269	4,797	581	1,138
48"	240"	02R48X240	25,978	28,193	2,269	2,269	4,968	581	1,138

Order Code	Specification Information	Refer To Accessories Section	Pricing Tiers
Example: 02R42X72-T003-PM01-MC01-GM2-MC01-UCO	To order please specify pattern number including:	Please refer to Accessories section, page 211 for power details.	Please refer to Materials and Finish page 7 for specification details.
02 Highline Collection	1. Top finish	Grommet options available in these finishes:	T1 and T2 pricing includes powder coated base finish.
R Rectangular	2. Trim Finish (only applies if trim type is metal or leather)	Powder coated	There is an upcharge for plated base finishes as highlighted above.
42 Depth	3. Base finish	Premium (Polished Chrome, Satin Nickel or Oil Rubbed Bronze)	For additional stone options and pricing please contact your sales representative."
72 Width	4. Grommet option	Power Box Options	
T003 Top Finish	5. Grommet finish (only applies if grommets are selected)	Code: Description:	
PM01 Trim Finish	6. Power box option	NP No Power	
MC01 Base Finish	7. Table-top power finish (only applies if table-top power is selected)	UCO Undermount	
GM2 Grommet Opt.	Trim Type	ECO Table Top Lid	
MC01 Grommet Finish	N = No trim	T1E Tabletop 1-Sided Lid	
UCO Undermount	M = Metal (available in Premium and Powder Coat finishes)	T2C Tabletop 2-Sided Lid	
	L = Leather	Must select Wire Management Column and Finish:	
		Powder coated	
		Premium (Polished Chrome, Satin Nickel or Oil Rubbed Bronze)	

Rectangular Conference Tables

42"-48" Deep Tops

Glass Top

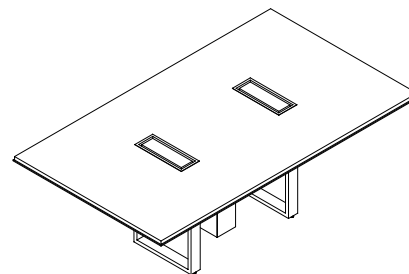

D	W	Pattern No.	GC__ Top	GE__ Top	PM01/ PM02 Edge Upcharge	PM03 Edge Upcharge	AU__ Edge Upcharge	PM01/ PM02 Base Upcharge	PM03 Base Upcharge
42"	72"	02R42X72	\$13,849	\$14,376	\$821	\$821	\$1,967	\$387	\$759
42"	84"	02R42X84	15,080	15,697	973	973	2,173	387	759
48"	72"	02R48X72	14,637	15,239	849	849	2,069	387	759
48"	84"	02R48X84	16,015	16,718	1,323	1,323	2,278	387	759
48"	96"	02R48X96	17,032	17,836	1,323	1,323	2,484	387	759
48"	108"	02R48X108	18,621	19,525	1,323	1,323	2,691	387	759
48"	120"	02R48X120	20,218	21,222	1,379	1,379	2,898	387	759
48"	132"	02R48X132	24,162	25,267	1,380	1,380	3,105	387	759
48"	144"	02R48X144	25,638	26,842	1,379	1,379	3,313	581	1,138
48"	156"	02R48X156	26,893	28,197	1,379	1,379	3,520	581	1,138
48"	168"	02R48X168	28,605	30,009	2,269	2,269	3,727	581	1,138
48"	180"	02R48X180	29,645	31,151	2,269	2,269	3,933	581	1,138
48"	192"	02R48X192	31,434	33,039	2,269	2,269	4,141	581	1,138
48"	204"	02R48X204	33,130	34,836	2,269	2,269	4,348	581	1,138
48"	216"	02R48X216	34,230	36,036	2,269	2,269	4,554	581	1,138
48"	228"	02R48X228	35,613	37,518	2,269	2,269	4,797	581	1,138
48"	240"	02R48X240	37,010	39,017	2,269	2,269	4,968	581	1,138

Order Code	Specification Information	Refer To Accessories Section	Pricing Tiers
Example: 02R42X72-GE01-PM01-MC01-GM2-MC01-UCO	To order please specify pattern number including:	Please refer to Accessories section, page 211 for power details.	Please refer to Materials and Finish page 7 for specification details.
02 Highline Collection	1. Top finish	Grommet options available in these finishes:	T1 and T2 pricing includes powder coated base finish.
R Rectangular	2. Trim Finish (only applies if trim type is metal or leather)	Powder coated	There is an upcharge for plated base finishes as highlighted above.
42 Depth	3. Base finish	Premium (Polished Chrome, Satin Nickel or Oil Rubbed Bronze)	For additional stone options and pricing please contact your sales representative."
72 Width	4. Grommet option	Power Box Options	
GE01 Top Finish	5. Grommet finish (only applies if grommets are selected)	Code: Description:	
PM01 Trim Finish	6. Power box option	NP No Power	
MC01 Base Finish	7. Table-top power finish (only applies if table-top power is selected)	UCO Undermount	
GM2 Grommet Opt.	Trim Type	ECO Table Top Lid	
MC01 Grommet Finish	N = No trim	T1E Tabletop 1-Sided Lid	
UCO Undermount	M = Metal (available in Premium and Powder Coat finishes)	T2C Tabletop 2-Sided Lid	
	L = Leather	Must select Wire Management Column and Finish:	
		Powder coated	
		Premium (Polished Chrome, Satin Nickel or Oil Rubbed Bronze)	

Rectangular Conference Tables

42"-48" Deep Tops

Corian Top

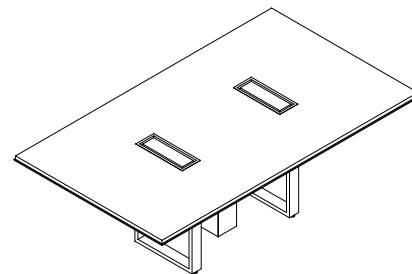

D	W	Pattern No.	CS01 Top	PM01/ PM02 Edge Upcharge	PM03 Edge Upcharge	AU__ Edge Upcharge	PM01/PM02 Base Upcharge	PM03 Base Upcharge
42"	72"	02R42X72	\$14,448	\$821	\$821	\$1,967	\$387	\$759
42"	84"	02R42X84	15,826	973	973	2,173	387	759
48"	72"	02R48X72	15,373	849	849	2,069	387	759
48"	84"	02R48X84	16,917	1,323	1,323	2,278	387	759
48"	96"	02R48X96	18,114	1,323	1,323	2,484	387	759
48"	108"	02R48X108	19,860	1,323	1,323	2,691	387	759
48"	120"	02R48X120	21,613	1,379	1,379	2,898	387	759
48"	132"	02R48X132	25,619	1,380	1,380	3,105	387	759
48"	144"	02R48X144	27,256	1,379	1,379	3,313	581	1,138
48"	156"	02R48X156	28,682	1,379	1,379	3,520	581	1,138
48"	168"	02R48X168	30,545	2,269	2,269	3,727	581	1,138
48"	180"	02R48X180	31,765	2,269	2,269	3,933	581	1,138
48"	192"	02R48X192	33,702	2,269	2,269	4,141	581	1,138
48"	204"	02R48X204	35,551	2,269	2,269	4,348	581	1,138
48"	216"	02R48X216	36,829	2,269	2,269	4,554	581	1,138
48"	228"	02R48X228	38,375	2,269	2,269	4,797	581	1,138
48"	240"	02R48X240	39,938	2,269	2,269	4,968	581	1,138

Order Code	Specification Information	Refer To Accessories Section	Pricing Tiers
Example: 02R42X72-CS01-PM01-MC01-GM2-MC01-UCO	To order please specify pattern number including:	Please refer to Accessories section, page 211 for power details.	Please refer to Materials and Finish page 7 for specification details.
02 Highline Collection	1. Top finish	Grommet options available in these finishes:	T1 and T2 pricing includes powder coated base finish.
R Rectangular	2. Trim Finish (only applies if trim type is metal or leather)	Powder coated	There is an upcharge for plated base finishes as highlighted above.
42 Depth	3. Base finish	Premium (Polished Chrome, Satin Nickel or Oil Rubbed Bronze)	For additional stone options and pricing please contact your sales representative."
72 Width	4. Grommet option	Power Box Options	
CS01 Top Finish	5. Grommet finish (only applies if grommets are selected)	Code: Description:	
PM01 Trim Finish	6. Power box option	NP No Power	
MC01 Base Finish	7. Table-top power finish (only applies if table-top power is selected)	UCO Undermount	
GM2 Grommet Opt.	Trim Type	ECO Table Top Lid	
MC01 Grommet Finish	N = No trim	T1E Tabletop 1-Sided Lid	
UCO Undermount	M = Metal (available in Premium and Powder Coat finishes)	T2C Tabletop 2-Sided Lid	
	L = Leather	Must select Wire Management Column and Finish:	
		Powder coated	
		Premium (Polished Chrome, Satin Nickel or Oil Rubbed Bronze)	

Rectangular Conference Tables

54" Deep Tops

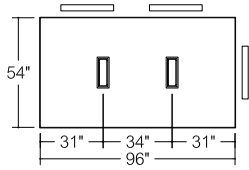
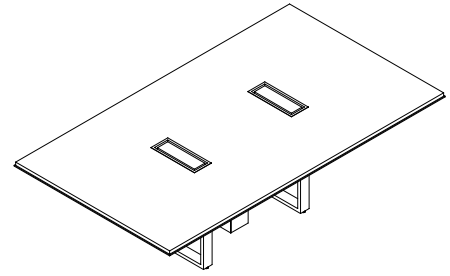

02R54X96
6 - 8 Person Table

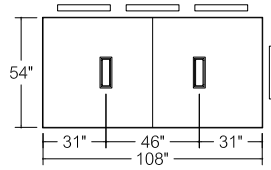

02R54X108
8 Person Table

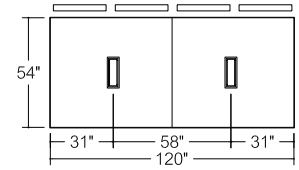

02R54X120
10 Person Table

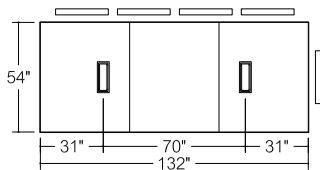

02R54X132
10 Person Table

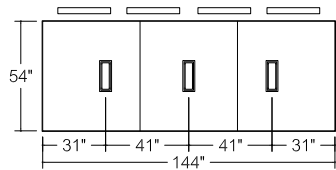

02R54X144
10 Person Table

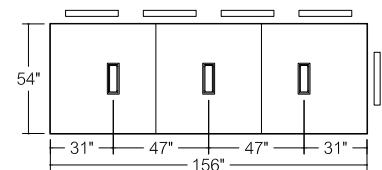

02R54X156
10 - 12 Person Table

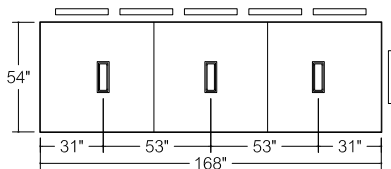

02R54X168
12 Person Table

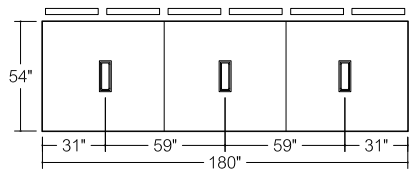

02R54X180
14 Person Table

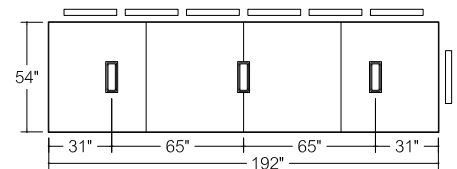

02R54X192
14 Person Table

Rectangular Conference Tables

54" Deep Tops

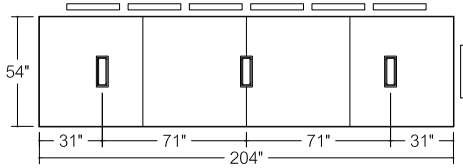
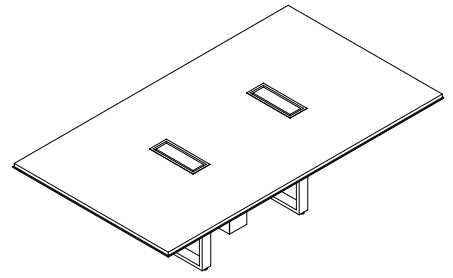

02R54X204

14 Person Table

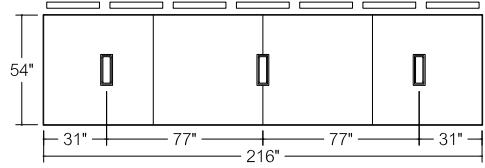

02R54X216

16 Person Table

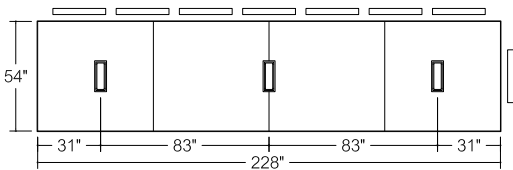

02R54X228

16 Person Table

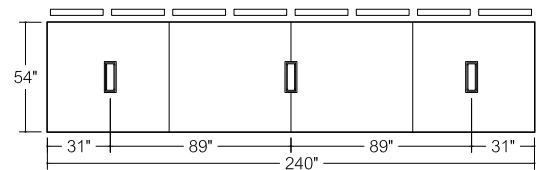

02R54X240

18 Person Table

Rectangular Conference Tables

54" Deep Tops

Veneer Top

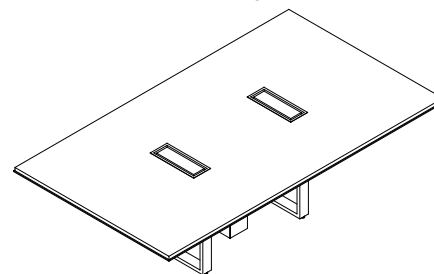

D	W	Pattern No.	T1__ Top	T2__ Top	PM01/ PM02 Edge Upcharge	PM03 Edge Upcharge	AU__ Edge Upcharge	PM01/ PM02 Base Upcharge	PM03 Base Upcharge
54"	96"	02R54X96	\$14,135	\$15,131	\$1,353	\$1,353	\$2,588	\$387	\$759
54"	108"	02R54X108	15,314	16,436	1,353	1,353	2,794	387	759
54"	120"	02R54X120	16,503	17,747	1,353	1,353	3,002	387	759
54"	132"	02R54X132	20,243	21,614	1,542	1,542	3,208	387	759
54"	144"	02R54X144	21,300	22,794	1,542	1,542	3,415	581	1,138
54"	156"	02R54X156	21,861	23,479	1,542	1,542	3,623	581	1,138
54"	168"	02R54X168	23,163	24,909	2,300	2,300	3,829	581	1,138
54"	180"	02R54X180	23,790	25,658	2,300	2,300	4,036	581	1,138
54"	192"	02R54X192	26,085	28,079	2,300	2,300	4,244	581	1,138
54"	204"	02R54X204	26,724	28,841	2,300	2,300	4,451	581	1,138
54"	216"	02R54X216	27,376	29,619	2,300	2,300	4,658	581	1,138
54"	228"	02R54X228	27,996	30,362	2,300	2,300	4,865	581	1,138
54"	240"	02R54X240	28,641	31,132	2,300	2,300	5,072	581	1,138

Order Code	Specification Information	Refer To Accessories Section	Pricing Tiers
Example: 02R54X96-T003-PM01-MC01-GM2-MC01-UCO	To order please specify pattern number including:	Please refer to Accessories section, page 211 for power details.	Please refer to Materials and Finish page 7 for specification details.
02 Highline Collection	1. Top finish	Grommet options available in these finishes:	T1 and T2 pricing includes powder coated base finish.
R Rectangular	2. Trim Finish (only applies if trim type is metal or leather)	Powder coated	There is an upcharge for plated base finishes as highlighted above.
54 Depth	3. Base finish	Premium (Polished Chrome, Satin Nickel or Oil Rubbed Bronze)	For additional stone options and pricing please contact your sales representative."
96 Width	4. Grommet option	Power Box Options	
T003 Top Finish	5. Grommet finish (only applies if grommets are selected)	Code: Description:	
PM01 Trim Finish	6. Power box option	NP No Power	
MC01 Base Finish	7. Table-top power finish (only applies if table-top power is selected)	UCO Undermount	
GM2 Grommet Opt.	Trim Type	ECO Table Top Lid	
MC01 Grommet Finish	N = No trim	T1E Tabletop 1-Sided Lid	
UCO Undermount	M = Metal (available in Premium and Powder Coat finishes)	T2C Tabletop 2-Sided Lid	
	L = Leather	Must select Wire Management Column and Finish:	
		Powder coated	
		Premium (Polished Chrome, Satin Nickel or Oil Rubbed Bronze)	

Rectangular Conference Tables

54" Deep Tops

Glass Top

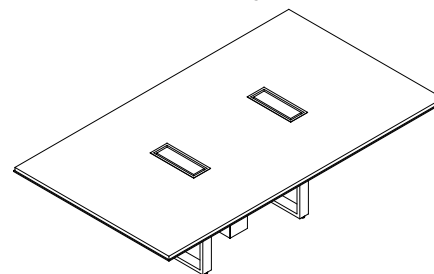

D	W	Pattern No.	GC__ Top	GE__ Top	PM01/ PM02 Edge Upcharge	PM03 Edge AU__ Edge Upcharge	PM01/ PM02 Base Upcharge	PM03 Base Upcharge	
54"	96"	02R54X96	\$19,201	\$20,104	\$1,353	\$1,353	\$2,588	\$387	\$759
54"	108"	02R54X108	20,992	22,007	1,353	1,353	2,794	387	759
54"	120"	02R54X120	22,787	23,915	1,353	1,353	3,002	387	759
54"	132"	02R54X132	27,245	28,487	1,542	1,542	3,208	387	759
54"	144"	02R54X144	28,906	30,261	1,542	1,542	3,415	581	1,138
54"	156"	02R54X156	30,049	31,516	1,542	1,542	3,623	581	1,138
54"	168"	02R54X168	31,967	33,546	2,300	2,300	3,829	581	1,138
54"	180"	02R54X180	33,177	34,869	2,300	2,300	4,036	581	1,138
54"	192"	02R54X192	36,128	37,935	2,300	2,300	4,244	581	1,138
54"	204"	02R54X204	37,353	39,273	2,300	2,300	4,451	581	1,138
54"	216"	02R54X216	38,591	40,624	2,300	2,300	4,658	581	1,138
54"	228"	02R54X228	39,798	41,942	2,300	2,300	4,865	581	1,138
54"	240"	02R54X240	41,028	43,286	2,300	2,300	5,072	581	1,138

Order Code	Specification Information	Refer To Accessories Section	Pricing Tiers
Example: 02R54X96-GE01-PM01-MC01-GM2-MC01-UCO	To order please specify pattern number including:	Please refer to Accessories section, page 211 for power details.	Please refer to Materials and Finish page 7 for specification details.
02 Highline Collection	1. Top finish	Grommet options available in these finishes:	T1 and T2 pricing includes powder coated base finish.
R Rectangular	2. Trim Finish (only applies if trim type is metal or leather)	Powder coated	There is an upcharge for plated base finishes as highlighted above.
54 Depth	3. Base finish	Premium (Polished Chrome, Satin Nickel or Oil Rubbed Bronze)	For additional stone options and pricing please contact your sales representative."
96 Width	4. Grommet option	Power Box Options	
GE01 Top Finish	5. Grommet finish (only applies if grommets are selected)	Code: Description:	
PM01 Trim Finish	6. Power box option	NP No Power	
MC01 Base Finish	7. Table-top power finish (only applies if table-top power is selected)	UCO Undermount	
GM2 Grommet Opt.	Trim Type	ECO Table Top Lid	
MC01 Grommet Finish	N = No trim	T1E Tabletop 1-Sided Lid	
UCO Undermount	M = Metal (available in Premium and Powder Coat finishes)	T2C Tabletop 2-Sided Lid	
	L = Leather	Must select Wire Management Column and Finish:	
		Powder coated	
		Premium (Polished Chrome, Satin Nickel or Oil Rubbed Bronze)	

Rectangular Conference Tables

54" Deep Tops
Corian Top

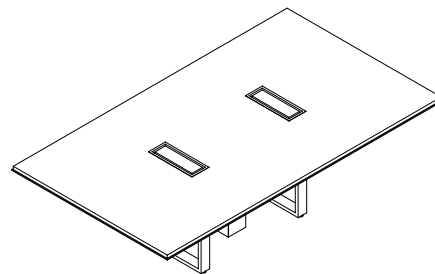

D	W	Pattern No.	CS01 Top	PM01/ PM02 Edge Upcharge	PM03 Edge Upcharge	AU__ Edge Upcharge	PM01/ PM02 Base Upcharge	PM03 Base Upcharge
54"	96"	02R54X96	\$20,417	\$1,353	\$1,353	\$2,588	\$387	\$759
54"	108"	02R54X108	22,382	1,353	1,353	2,794	387	759
54"	120"	02R54X120	24,354	1,353	1,353	3,002	387	759
54"	132"	02R54X132	28,881	1,542	1,542	3,208	387	759
54"	144"	02R54X144	30,722	1,542	1,542	3,415	581	1,138
54"	156"	02R54X156	32,069	1,542	1,542	3,623	581	1,138
54"	168"	02R54X168	34,158	2,300	2,300	3,829	581	1,138
54"	180"	02R54X180	35,570	2,300	2,300	4,036	581	1,138
54"	192"	02R54X192	38,651	2,300	2,300	4,244	581	1,138
54"	204"	02R54X204	40,074	2,300	2,300	4,451	581	1,138
54"	216"	02R54X216	41,513	2,300	2,300	4,658	581	1,138
54"	228"	02R54X228	42,916	2,300	2,300	4,865	581	1,138
54"	240"	02R54X240	44,348	2,300	2,300	5,072	581	1,138

Order Code	Specification Information	Refer To Accessories Section	Pricing Tiers
Example: 02R54X96-CS01-PM01-MC01-GM2-MC01-UCO	To order please specify pattern number including:	Please refer to Accessories section, page 211 for power details.	Please refer to Materials and Finish page 7 for specification details.
02 Highline Collection	1. Top finish	Grommet options available in these finishes:	T1 and T2 pricing includes powder coated base finish.
R Rectangular	2. Trim Finish (only applies if trim type is metal or leather)	Powder coated	There is an upcharge for plated base finishes as highlighted above.
54 Depth	3. Base finish	Premium (Polished Chrome, Satin Nickel or Oil Rubbed Bronze)	For additional stone options and pricing please contact your sales representative."
96 Width	4. Grommet option	Power Box Options	
CS01 Top Finish	5. Grommet finish (only applies if grommets are selected)	Code: Description:	
PM01 Trim Finish	6. Power box option	NP No Power	
MC01 Base Finish	7. Table-top power finish (only applies if table-top power is selected)	UCO Undermount	
GM2 Grommet Opt.	Trim Type	ECO Table Top Lid	
MC01 Grommet Finish	N = No trim	T1E Tabletop 1-Sided Lid	
UCO Undermount	M = Metal (available in Premium and Powder Coat finishes)	T2C Tabletop 2-Sided Lid	
	L = Leather	Must select Wire Management Column and Finish:	
		Powder coated	
		Premium (Polished Chrome, Satin Nickel or Oil Rubbed Bronze)	

Rectangular Conference Tables

60" Deep Tops

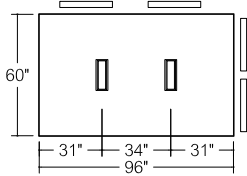
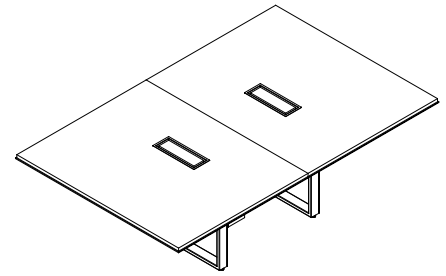

O2R60X96
8 Person Table

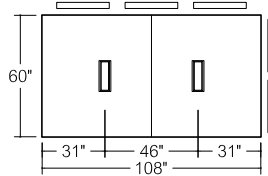

O2R60X108
10 Person Table

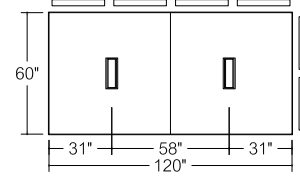

O2R60X120
12 Person Table

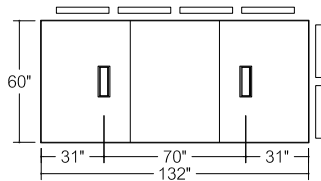

O2R60X132
12 Person Table

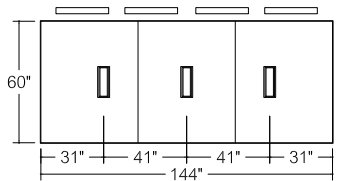

O2R60X144
12 Person Table

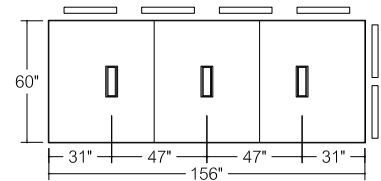

O2R60X156
12 Person Table

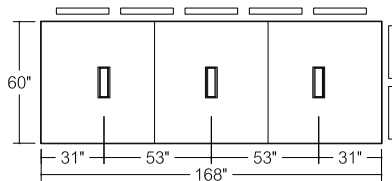

O2R60X168
14 Person Table

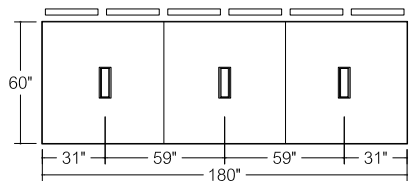

O2R60X180
16 Person Table

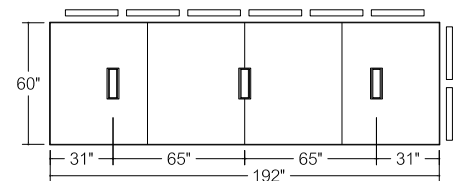

O2R60X192
16 Person Table

Rectangular Conference Tables

60" Deep Tops

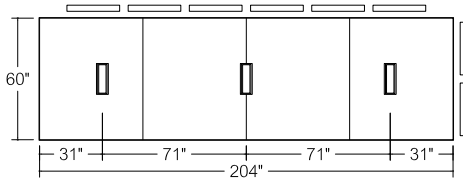
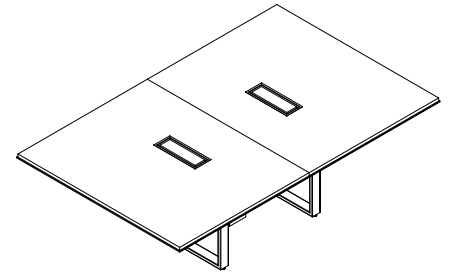

02R60X204
16 Person Table

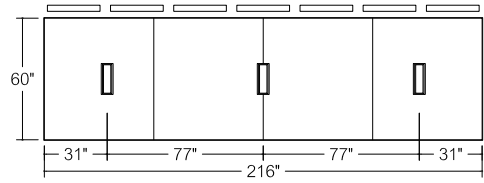

02R60X216
18 Person Table

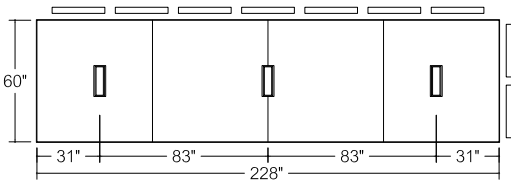

02R60X228
18 Person Table

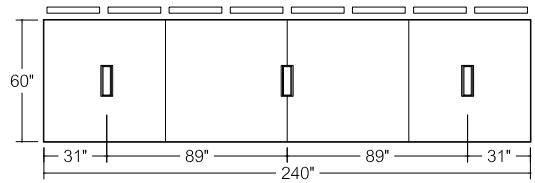

02R60X240
20 Person Table

Rectangular Conference Tables

60" Deep Tops
Veneer Top

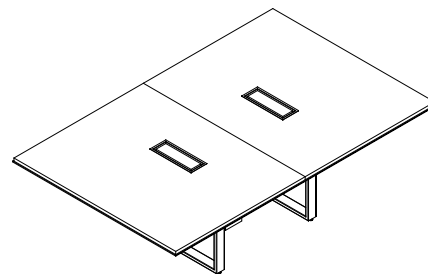

D	W	Pattern No.	T1__ Top	T2__ Top	PM01/ PM02 Edge Upcharge	PM03 Edge Upcharge	AU__ Edge Upcharge	PM01/ PM02 Base Upcharge	PM03 Base Upcharge
60"	96"	02R60X96	\$14,648	\$15,755	\$1,371	\$1,371	\$2,691	\$368	\$1,271
60"	108"	02R60X108	15,781	17,026	1,371	1,371	2,898	368	1,271
60"	120"	02R60X120	16,839	18,221	1,371	1,371	3,105	368	1,271
60"	132"	02R60X132	20,029	21,550	1,563	1,563	3,313	368	1,271
60"	144"	02R60X144	22,104	23,766	1,563	1,563	3,520	552	1,905
60"	156"	02R60X156	23,012	24,811	1,563	1,563	3,727	552	1,905
60"	168"	02R60X168	24,503	26,439	2,311	2,311	3,933	552	1,905
60"	180"	02R60X180	25,511	27,587	2,311	2,311	4,141	552	1,905
60"	192"	02R60X192	26,677	28,891	2,311	2,311	4,348	552	1,905
60"	204"	02R60X204	27,824	30,176	2,311	2,311	4,554	552	1,905
60"	216"	02R60X216	28,809	31,299	2,311	2,311	4,762	552	1,905
60"	228"	02R60X228	29,857	32,487	2,311	2,311	4,968	552	1,905
60"	240"	02R60X240	30,933	33,702	2,311	2,311	5,175	552	1,905

Order Code	Specification Information	Refer To Accessories Section	Pricing Tiers
Example: 02R60X96-T003-PM01-MC01-GM2-MC01-UCO	To order please specify pattern number including:	Please refer to Accessories section, page 211 for power details.	Please refer to Materials and Finish page 7 for specification details.
02 Highline Collection	1. Top finish	Grommet options available in these finishes:	T1 and T2 pricing includes powder coated base finish.
R Rectangular	2. Trim Finish (only applies if trim type is metal or leather)	Powder coated	There is an upcharge for plated base finishes as highlighted above.
60 Depth	3. Base finish	Premium (Polished Chrome, Satin Nickel or Oil Rubbed Bronze)	For additional stone options and pricing please contact your sales representative."
96 Width	4. Grommet option	Power Box Options	
T003 Top Finish	5. Grommet finish (only applies if grommets are selected)	Code: Description:	
PM01 Trim Finish	6. Power box option	NP No Power	
MC01 Base Finish	7. Table-top power finish (only applies if table-top power is selected)	UCO Undermount	
GM2 Grommet Opt.	Trim Type	ECO Table Top Lid	
MC01 Grommet Finish	N = No trim	T1E Tabletop 1-Sided Lid	
UCO Undermount	M = Metal (available in Premium and Powder Coat finishes)	T2C Tabletop 2-Sided Lid	
	L = Leather	Must select Wire Management Column and Finish:	
		Powder coated	
		Premium (Polished Chrome, Satin Nickel or Oil Rubbed Bronze)	

Rectangular Conference Tables

60" Deep Tops

Glass Top

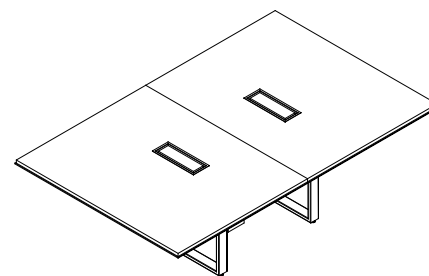

D	W	Pattern No.	GC__ Top	GE__ Top	PM01/ PM02 Edge Upcharge	PM03 Edge Upcharge	AU__ Edge Upcharge	PM01/ PM02 Base Upcharge	PM03 Base Upcharge
60"	96"	02R60X96	\$20,235	\$21,238	\$1,371	\$1,371	\$2,691	\$368	\$1,271
60"	108"	02R60X108	22,034	23,165	1,371	1,371	2,898	368	1,271
60"	120"	02R60X120	23,757	25,012	1,371	1,371	3,105	368	1,271
60"	132"	02R60X132	27,705	29,083	1,563	1,563	3,313	368	1,271
60"	144"	02R60X144	30,490	31,994	1,563	1,563	3,520	552	1,905
60"	156"	02R60X156	32,057	33,688	1,563	1,563	3,727	552	1,905
60"	168"	02R60X168	34,230	35,986	2,311	2,311	3,933	552	1,905
60"	180"	02R60X180	35,903	37,784	2,311	2,311	4,141	552	1,905
60"	192"	02R60X192	37,739	39,746	2,311	2,311	4,348	552	1,905
60"	204"	02R60X204	39,555	41,687	2,311	2,311	4,554	552	1,905
60"	216"	02R60X216	41,201	43,460	2,311	2,311	4,762	552	1,905
60"	228"	02R60X228	42,917	45,301	2,311	2,311	4,968	552	1,905
60"	240"	02R60X240	44,659	47,167	2,311	2,311	5,175	552	1,905

Order Code	Specification Information	Refer To Accessories Section	Pricing Tiers
Example: 02R60X96-GE01-PM01-MC01-GM2-MC01-UCO	To order please specify pattern number including:	Please refer to Accessories section, page 211 for power details.	Please refer to Materials and Finish page 7 for specification details.
02 Highline Collection	1. Top finish	Grommet options available in these finishes:	T1 and T2 pricing includes powder coated base finish.
R Rectangular	2. Trim Finish (only applies if trim type is metal or leather)	Powder coated	There is an upcharge for plated base finishes as highlighted above.
60 Depth	3. Base finish	Premium (Polished Chrome, Satin Nickel or Oil Rubbed Bronze)	For additional stone options and pricing please contact your sales representative."
96 Width	4. Grommet option	Power Box Options	
GE01 Top Finish	5. Grommet finish (only applies if grommets are selected)	Code: Description:	
PM01 Trim Finish	6. Power box option	NP No Power	
MC01 Base Finish	7. Table-top power finish (only applies if table-top power is selected)	UCO Undermount	
GM2 Grommet Opt.	Trim Type	ECO Table Top Lid	
MC01 Grommet Finish	N = No trim	T1E Tabletop 1-Sided Lid	
UCO Undermount	M = Metal (available in Premium and Powder Coat finishes)	T2C Tabletop 2-Sided Lid	
	L = Leather	Must select Wire Management Column and Finish:	
		Powder coated	
		Premium (Polished Chrome, Satin Nickel or Oil Rubbed Bronze)	

Rectangular Conference Tables

60" Deep Tops
Corian Top

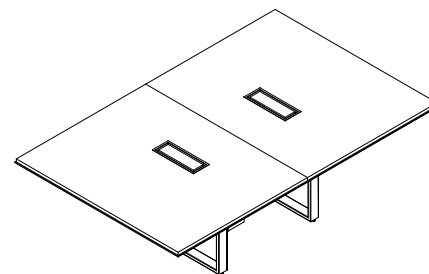

D	W	Pattern No.	CS01 Top	PM01/PM02 Edge Upcharge	PM03 Edge Upcharge	AU__ Edge Upcharge	PM01/PM02 Base Upcharge	PM03 Base Upcharge
60"	96"	02R60X96	\$21,630	\$1,371	\$1,371	\$2,691	\$368	\$1,271
60"	108"	02R60X108	23,633	1,371	1,371	2,898	368	1,271
60"	120"	02R60X120	25,562	1,371	1,371	3,105	368	1,271
60"	132"	02R60X132	29,626	1,563	1,563	3,313	368	1,271
60"	144"	02R60X144	32,576	1,563	1,563	3,520	552	1,905
60"	156"	02R60X156	34,356	1,563	1,563	3,727	552	1,905
60"	168"	02R60X168	36,718	2,311	2,311	3,933	552	1,905
60"	180"	02R60X180	38,599	2,311	2,311	4,141	552	1,905
60"	192"	02R60X192	40,638	2,311	2,311	4,348	552	1,905
60"	204"	02R60X204	42,656	2,311	2,311	4,554	552	1,905
60"	216"	02R60X216	44,515	2,311	2,311	4,762	552	1,905
60"	228"	02R60X228	46,437	2,311	2,311	4,968	552	1,905
60"	240"	02R60X240	48,385	2,311	2,311	5,175	552	1,905

Order Code	Specification Information	Refer To Accessories Section	Pricing Tiers
Example: 02R60X96-CS01-PM01-MC01-GM2-MC01-UCO	To order please specify pattern number including:	Please refer to Accessories section, page 211 for power details.	Please refer to Materials and Finish page 7 for specification details.
02 Highline Collection	1. Top finish	Grommet options available in these finishes:	T1 and T2 pricing includes powder coated base finish.
R Rectangular	2. Trim Finish (only applies if trim type is metal or leather)	Powder coated	There is an upcharge for plated base finishes as highlighted above.
60 Depth	3. Base finish	Premium (Polished Chrome, Satin Nickel or Oil Rubbed Bronze)	For additional stone options and pricing please contact your sales representative."
96 Width	4. Grommet option	Power Box Options	
CS01 Top Finish	5. Grommet finish (only applies if grommets are selected)	Code: Description:	
PM01 Trim Finish	6. Power box option	NP No Power	
MC01 Base Finish	7. Table-top power finish (only applies if table-top power is selected)	UCO Undermount	
GM2 Grommet Opt.	Trim Type	ECO Table Top Lid	
MC01 Grommet Finish	N = No trim	T1E Tabletop 1-Sided Lid	
UCO Undermount	M = Metal (available in Premium and Powder Coat finishes)	T2C Tabletop 2-Sided Lid	
	L = Leather	Must select Wire Management Column and Finish:	
		Powder coated	
		Premium (Polished Chrome, Satin Nickel or Oil Rubbed Bronze)	

Rectangular Conference Tables

72" Deep Tops

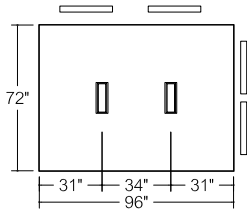
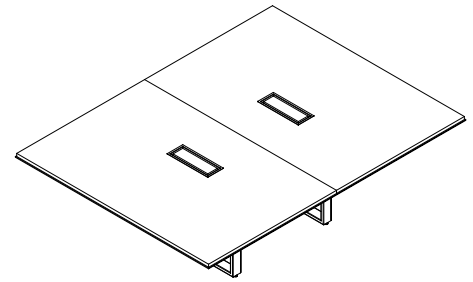

02R72X96
8 Person Table

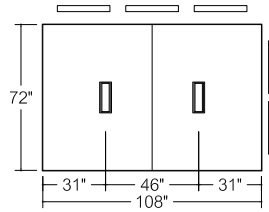

02R72X108
10 Person Table

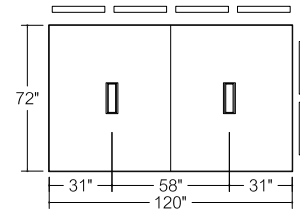

02R72X120
12 Person Table

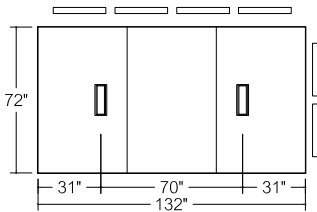

02R72X132
12 Person Table

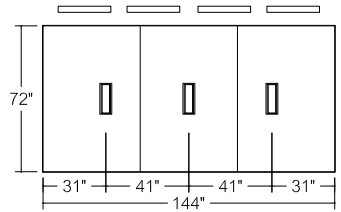

02R72X144
12 Person Table

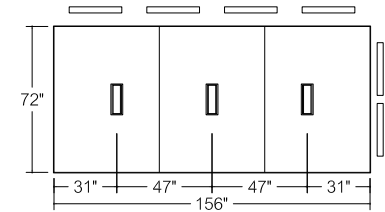

02R72X156
12 Person Table

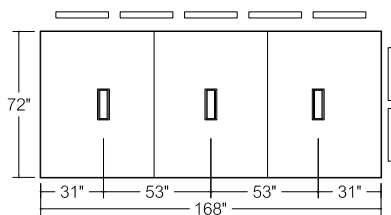

02R72X168
14 Person Table

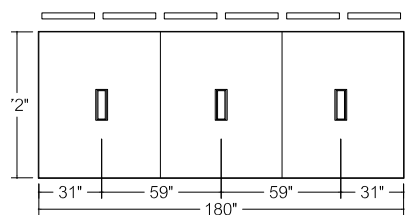

02R72X180
16 Person Table

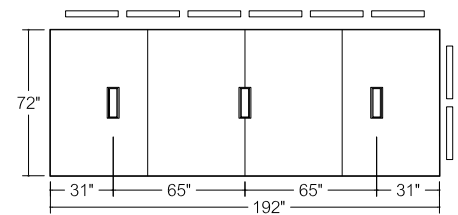

02R72X192
16 Person Table

Rectangular Conference Tables

72" Deep Tops

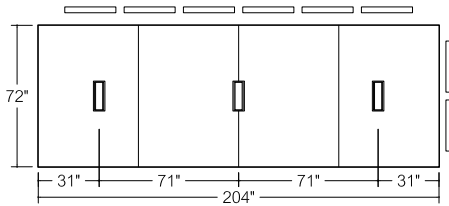
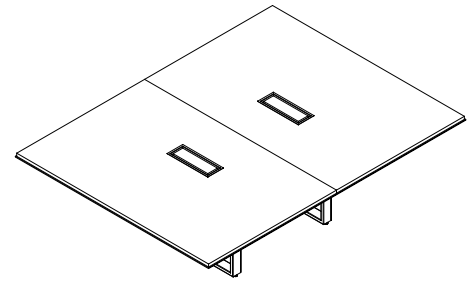

02R72X204

16 Person Table

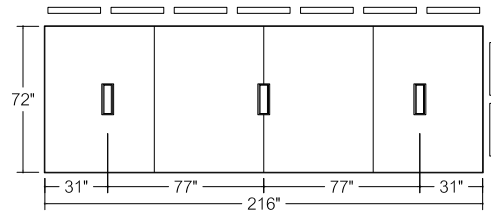

02R72X216

18 Person Table

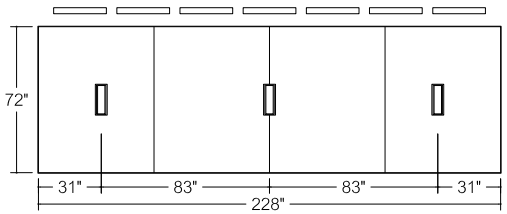

02R72X228

18 Person Table

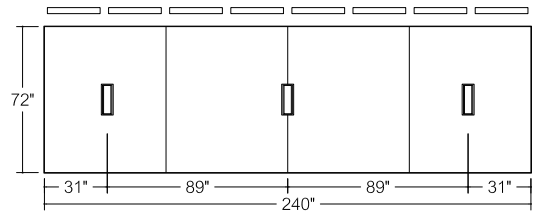

02R72X240

20 Person Table

Rectangular Conference Tables

72" Deep Tops
Veneer Top

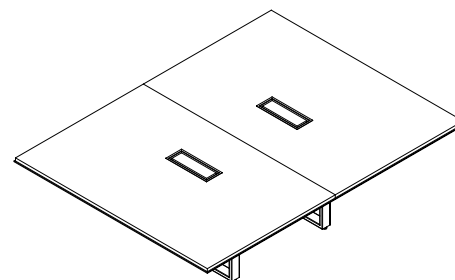

D	W	Pattern No.	T1__ Top	T2__ Top	PM01/ PM02 Edge Upcharge	PM03 Edge Upcharge	AU__ Edge Upcharge	PM01/ PM02 Base Upcharge	PM03 Base Upcharge
72"	96"	02R72X96	\$17,129	\$18,457	\$1,475	\$1,475	\$2,898	\$368	\$1,271
72"	108"	02R72X108	18,469	19,964	1,475	1,475	3,105	368	1,271
72"	120"	02R72X120	19,744	21,405	1,475	1,475	3,313	368	1,271
72"	132"	02R72X132	22,922	24,750	1,563	1,563	3,520	368	1,271
72"	144"	02R72X144	24,599	26,592	1,563	1,563	3,727	552	1,905
72"	156"	02R72X156	26,142	28,301	1,563	1,563	3,933	552	1,905
72"	168"	02R72X168	27,429	29,754	2,311	2,311	4,141	581	2,734
72"	180"	02R72X180	28,664	31,155	2,311	2,311	4,348	581	2,734
72"	192"	02R72X192	29,995	32,652	2,311	2,311	4,554	581	2,734
72"	204"	02R72X204	31,266	34,088	2,311	2,311	4,762	581	2,734
72"	216"	02R72X216	32,545	35,534	2,311	2,311	4,968	581	2,734
72"	228"	02R72X228	33,796	36,952	2,311	2,311	5,175	581	2,734
72"	240"	02R72X240	35,052	38,374	2,311	2,311	5,383	581	2,734

Order Code	Specification Information	Refer To Accessories Section	Pricing Tiers
Example: 02R72X96-T003-PM01-MC01-GM2-MC01-UCO	To order please specify pattern number including:	Please refer to Accessories section, page 211 for power details.	Please refer to Materials and Finish page 7 for specification details.
02 Highline Collection	1. Top finish	Grommet options available in these finishes:	T1 and T2 pricing includes powder coated base finish.
R Rectangular	2. Trim Finish (only applies if trim type is metal or leather)	Powder coated	There is an upcharge for plated base finishes as highlighted above.
72 Depth	3. Base finish	Premium (Polished Chrome, Satin Nickel or Oil Rubbed Bronze)	For additional stone options and pricing please contact your sales representative."
96 Width	4. Grommet option	Power Box Options	
T003 Top Finish	5. Grommet finish (only applies if grommets are selected)	Code: Description:	
PM01 Trim Finish	6. Power box option	NP No Power	
MC01 Base Finish	7. Table-top power finish (only applies if table-top power is selected)	UCO Undermount	
GM2 Grommet Opt.	Trim Type	ECO Table Top Lid	
MC01 Grommet Finish	N = No trim	T1E Tabletop 1-Sided Lid	
UCO Undermount	M = Metal (available in Premium and Powder Coat finishes)	T2C Tabletop 2-Sided Lid	
	L = Leather	Must select Wire Management Column and Finish:	
		Powder coated	
		Premium (Polished Chrome, Satin Nickel or Oil Rubbed Bronze)	

Rectangular Conference Tables

72" Deep Tops
Glass Top

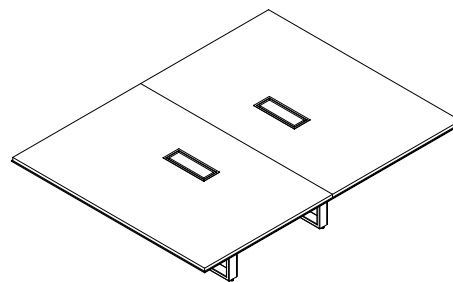

D	W	Pattern No.	GC__ Top	GE__ Top	PM01/ PM02 Edge Upcharge	PM03 Edge Upcharge	AU__ Edge Upcharge	PM01/ PM02 Base Upcharge	PM03 Base Upcharge
72"	96"	02R72X96	\$23,813	\$25,017	\$1,475	\$1,475	\$2,898	\$368	\$1,271
72"	108"	02R72X108	25,955	27,310	1,475	1,475	3,105	368	1,271
72"	120"	02R72X120	28,029	29,533	1,475	1,475	3,313	368	1,271
72"	132"	02R72X132	32,087	33,742	1,563	1,563	3,520	368	1,271
72"	144"	02R72X144	34,578	36,385	1,563	1,563	3,727	552	1,905
72"	156"	02R72X156	36,933	38,890	1,563	1,563	3,933	552	1,905
72"	168"	02R72X168	39,018	41,125	2,311	2,311	4,141	581	2,734
72"	180"	02R72X180	41,051	43,309	2,311	2,311	4,348	581	2,734
72"	192"	02R72X192	43,183	45,592	2,311	2,311	4,554	581	2,734
72"	204"	02R72X204	45,253	47,812	2,311	2,311	4,762	581	2,734
72"	216"	02R72X216	47,331	50,153	2,311	2,311	4,968	581	2,734
72"	228"	02R72X228	49,381	52,242	2,311	2,311	5,175	581	2,734
72"	240"	02R72X240	51,436	54,446	2,311	2,311	5,383	581	2,734

Order Code	Specification Information	Refer To Accessories Section	Pricing Tiers
Example: 02R72X96-GE01-PM01-MC01-GM2-MC01-UCO	To order please specify pattern number including:	Please refer to Accessories section, page 211 for power details.	Please refer to Materials and Finish page 7 for specification details.
02 Highline Collection	1. Top finish	Grommet options available in these finishes:	T1 and T2 pricing includes powder coated base finish.
R Rectangular	2. Trim Finish (only applies if trim type is metal or leather)	Powder coated	There is an upcharge for plated base finishes as highlighted above.
72 Depth	3. Base finish	Premium (Polished Chrome, Satin Nickel or Oil Rubbed Bronze)	For additional stone options and pricing please contact your sales representative."
96 Width	4. Grommet option	Power Box Options	
GE01 Top Finish	5. Grommet finish (only applies if grommets are selected)	Code: Description:	
PM01 Trim Finish	6. Power box option	NP No Power	
MC01 Base Finish	7. Table-top power finish (only applies if table-top power is selected)	UCO Undermount	
GM2 Grommet Opt.	Trim Type	ECO Table Top Lid	
MC01 Grommet Finish	N = No trim	T1E Tabletop 1-Sided Lid	
UCO Undermount	M = Metal (available in Premium and Powder Coat finishes)	T2C Tabletop 2-Sided Lid	
	L = Leather	Must select Wire Management Column and Finish:	
		Powder coated	
		Premium (Polished Chrome, Satin Nickel or Oil Rubbed Bronze)	

Rectangular Conference Tables

72" Deep Tops
Corian Top

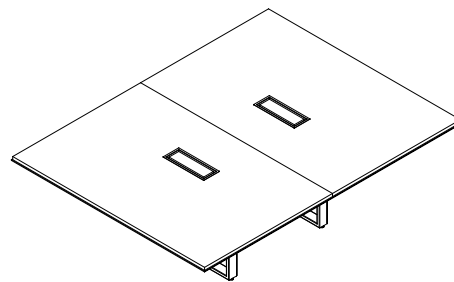

D	W	Pattern No.	CS01 Top	PM01/ PM02 Edge Upcharge	PM03 Edge Upcharge	AU__ Edge Upcharge	PM01/ PM02 Base Upcharge	PM03 Base Upcharge
72"	96"	02R72X96	\$25,506	\$1,475	\$1,475	\$2,898	\$368	\$1,271
72"	108"	02R72X108	27,893	1,475	1,475	3,105	368	1,271
72"	120"	02R72X120	30,214	1,475	1,475	3,313	368	1,271
72"	132"	02R72X132	34,440	1,563	1,563	3,520	368	1,271
72"	144"	02R72X144	37,163	1,563	1,563	3,727	552	1,905
72"	156"	02R72X156	39,754	1,563	1,563	3,933	552	1,905
72"	168"	02R72X168	42,088	2,311	2,311	4,141	581	2,734
72"	180"	02R72X180	44,370	2,311	2,311	4,348	581	2,734
72"	192"	02R72X192	46,748	2,311	2,311	4,554	581	2,734
72"	204"	02R72X204	49,064	2,311	2,311	4,762	581	2,734
72"	216"	02R72X216	51,391	2,311	2,311	4,968	581	2,734
72"	228"	02R72X228	53,692	2,311	2,311	5,175	581	2,734
72"	240"	02R72X240	56,114	2,311	2,311	5,383	581	2,734

Order Code	Specification Information	Refer To Accessories Section	Pricing Tiers
Example: 02R72X96-CS01-PM01-MC01-GM2-MC01-UCO	To order please specify pattern number including:	Please refer to Accessories section, page 211 for power details.	Please refer to Materials and Finish page 7 for specification details.
02 Highline Collection	1. Top finish	Grommet options available in these finishes:	T1 and T2 pricing includes powder coated base finish.
R Rectangular	2. Trim Finish (only applies if trim type is metal or leather)	Powder coated	There is an upcharge for plated base finishes as highlighted above.
72 Depth	3. Base finish	Premium (Polished Chrome, Satin Nickel or Oil Rubbed Bronze)	For additional stone options and pricing please contact your sales representative."
96 Width	4. Grommet option	Power Box Options	
CS01 Top Finish	5. Grommet finish (only applies if grommets are selected)	Code: Description:	
PM01 Trim Finish	6. Power box option	NP No Power	
MC01 Base Finish	7. Table-top power finish (only applies if table-top power is selected)	UCO Undermount	
GM2 Grommet Opt.	Trim Type	ECO Table Top Lid	
MC01 Grommet Finish	N = No trim	T1E Tabletop 1-Sided Lid	
UCO Undermount	M = Metal (available in Premium and Powder Coat finishes)	T2C Tabletop 2-Sided Lid	
	L = Leather	Must select Wire Management Column and Finish:	
		Powder coated	
		Premium (Polished Chrome, Satin Nickel or Oil Rubbed Bronze)	

Elliptical Conference Tables

48"-72" Deep Tops

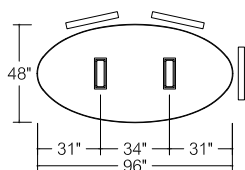
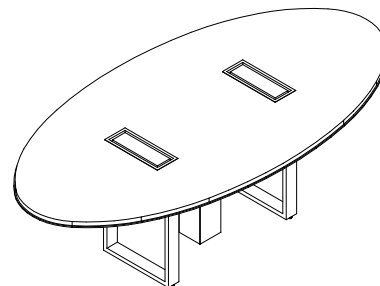

02E48X96
6 Person Table

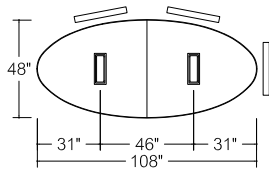

02E48X108
6 Person Table

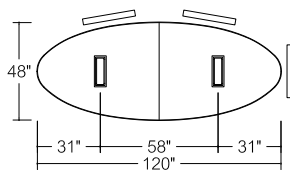

02E48X120
6 Person Table

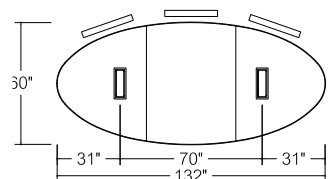

02E60X132
8 Person Table

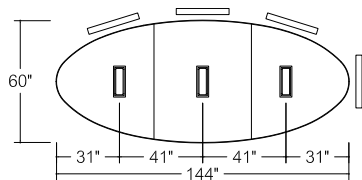

02E60X144
8 Person Table

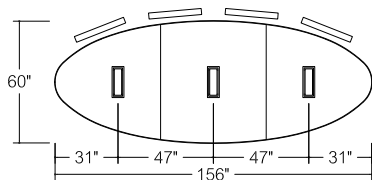

02E60X156
8 Person Table

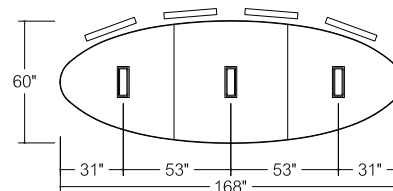

02E60X168
8 Person Table

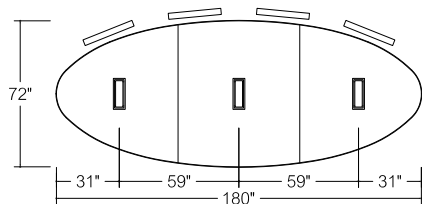

02E72X180
8 Person Table

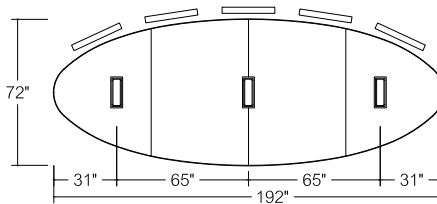

02E72X192
10 Person Table

Elliptical Conference Tables

48"-72" Deep Tops

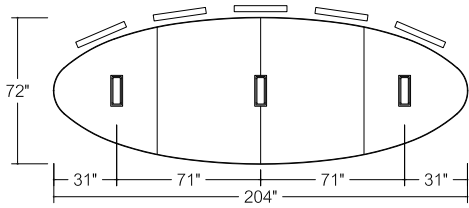
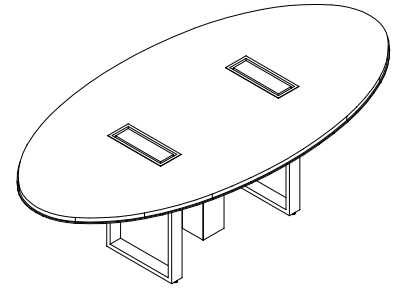

02E72X204
10 Person Table

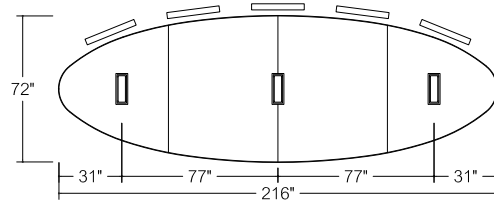

02E72X216
10 Person Table

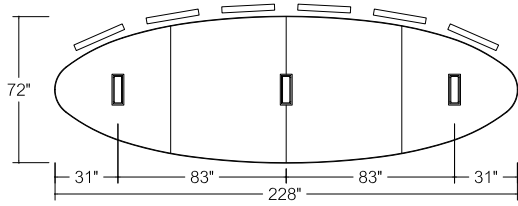

02E72X228
12 Person Table

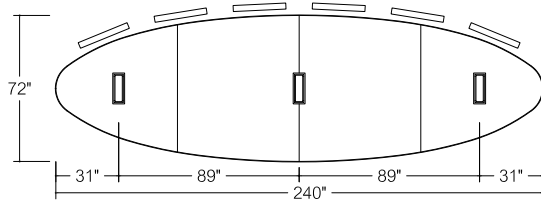

02E72X240
12 Person Table

Elliptical Conference Tables

48"-72" Deep Elliptical Tops

Veneer Top

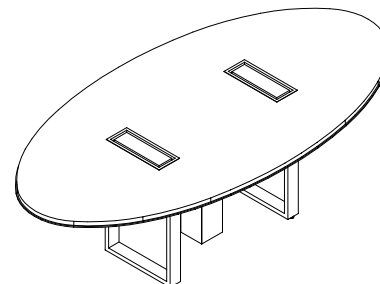

D	W	Pattern No.	T1__Top	T2__Top	PM01/ PM02 Edge Upcharge	PM03 Edge Upcharge	AU__ Edge Upcharge	PM01/ PM02 Base Upcharge	PM03 Base Upcharge
48"	96"	02E48X96	\$17,557	\$18,444	\$1,790	\$3,990	\$2,535	\$387	\$759
48"	108"	02E48X108	18,126	19,122	1,790	4,578	2,770	387	759
48"	120"	02E48X120	19,320	20,427	1,812	4,529	3,007	387	759
60"	132"	02E60X132	23,099	24,622	2,147	5,491	3,398	387	759
60"	144"	02E60X144	25,338	27,000	2,147	5,491	3,637	581	1,138
60"	156"	02E60X156	26,238	28,037	2,148	5,492	3,876	581	1,138
60"	168"	02E60X168	28,071	30,009	2,183	5,492	4,116	581	1,138
72"	180"	02E72X180	33,137	35,627	2,244	5,556	4,502	572	1,394
72"	192"	02E72X192	35,356	38,013	2,722	7,134	4,743	572	1,394
72"	204"	02E72X204	36,537	39,360	2,722	7,134	4,985	572	1,394
72"	216"	02E72X216	38,432	41,421	2,722	7,134	5,226	572	1,394
72"	228"	02E72X228	39,059	42,214	2,770	7,181	5,471	572	1,394
72"	240"	02E72X240	41,567	44,889	2,770	7,181	5,716	572	1,394

Order Code	Specification Information	Refer To Accessories Section	Pricing Tiers
Example: 02E48X96-T003-PM01-MC01-GM2-MC01-UCO	To order please specify pattern number including:	Please refer to Accessories section, page 211 for power details.	Please refer to Materials and Finish page 7 for specification details.
02 Highline Collection	1. Top finish	Grommet options available in these finishes:	T1 and T2 pricing includes powder coated base finish.
E Elliptical	2. Trim Finish (only applies if trim type is metal or leather)	Powder coated	There is an upcharge for plated base finishes as highlighted above.
48 Depth	3. Base finish	Premium (Polished Chrome, Satin Nickel or Oil Rubbed Bronze)	For additional stone options and pricing please contact your sales representative."
96 Width	4. Grommet option	Power Box Options	
T003 Top Finish	5. Grommet finish (only applies if grommets are selected)	Code: Description:	
PM01 Trim Finish	6. Power box option	NP No Power	
MC01 Base Finish	7. Table-top power finish (only applies if table-top power is selected)	UCO Undermount	
GM2 Grommet Opt.	Trim Type	ECO Table Top Lid	
MC01 Grommet Finish	N = No trim	T1E Tabletop 1-Sided Lid	
UCO Undermount	M = Metal (available in Premium and Powder Coat finishes)	T2C Tabletop 2-Sided Lid	
	L = Leather	Must select Wire Management Column and Finish:	
		Powder coated	
		Premium (Polished Chrome, Satin Nickel or Oil Rubbed Bronze)	

Elliptical Conference Tables

48"-72" Deep Elliptical Tops

Glass Top

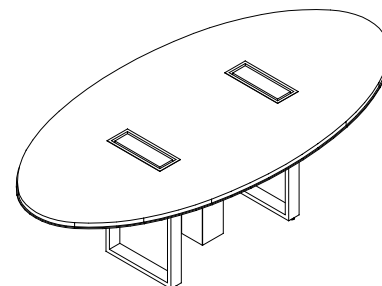

D	W	Pattern No.	GC__ Top	GE__ Top	PM01/ PM02 Edge Upcharge	PM03 Edge Upcharge	AU__ Edge Upcharge	PM01/ PM02 Base Upcharge	PM03 Base Upcharge
48"	96"	02E48X96	\$24,320	\$25,525	\$1,790	\$3,990	\$2,535	\$387	\$759
48"	108"	02E48X108	25,665	27,020	1,790	4,578	2,770	387	759
48"	120"	02E48X120	27,664	29,168	1,812	4,529	3,007	387	759
60"	132"	02E60X132	34,424	36,493	2,147	5,491	3,398	387	759
60"	144"	02E60X144	37,698	39,956	2,147	5,491	3,637	581	1,138
60"	156"	02E60X156	39,576	42,023	2,148	5,492	3,876	581	1,138
60"	168"	02E60X168	42,428	45,062	2,183	5,492	4,116	581	1,138
72"	180"	02E72X180	51,470	54,858	2,244	5,556	4,502	572	1,394
72"	192"	02E72X192	54,913	58,528	2,722	7,134	4,743	572	1,394
72"	204"	02E72X204	57,272	61,111	2,722	7,134	4,985	572	1,394
72"	216"	02E72X216	60,377	64,441	2,722	7,134	5,226	572	1,394
72"	228"	02E72X228	62,159	66,448	2,770	7,181	5,471	572	1,394
72"	240"	02E72X240	65,902	70,418	2,770	7,181	5,716	572	1,394

Order Code	Specification Information	Refer To Accessories Section	Pricing Tiers
Example: 02E48X96-GE01-PM01-MC01-GM2-MC01-UCO	To order please specify pattern number including:	Please refer to Accessories section, page 211 for power details.	Please refer to Materials and Finish page 7 for specification details.
02 Highline Collection	1. Top finish	Grommet options available in these finishes:	T1 and T2 pricing includes powder coated base finish.
E Elliptical	2. Trim Finish (only applies if trim type is metal or leather)	Powder coated	There is an upcharge for plated base finishes as highlighted above.
48 Depth	3. Base finish	Premium (Polished Chrome, Satin Nickel or Oil Rubbed Bronze)	For additional stone options and pricing please contact your sales representative."
96 Width	4. Grommet option	Power Box Options	
GE01 Top Finish	5. Grommet finish (only applies if grommets are selected)	Code: Description:	
PM01 Trim Finish	6. Power box option	NP No Power	
MC01 Base Finish	7. Table-top power finish (only applies if table-top power is selected)	UCO Undermount	
GM2 Grommet Opt.	Trim Type	ECO Table Top Lid	
MC01 Grommet Finish	N = No trim	T1E Tabletop 1-Sided Lid	
UCO Undermount	M = Metal (available in Premium and Powder Coat finishes)	T2C Tabletop 2-Sided Lid	
	L = Leather	Must select Wire Management Column and Finish:	
		Powder coated	
		Premium (Polished Chrome, Satin Nickel or Oil Rubbed Bronze)	

Elliptical Conference Tables

48"-72" Deep Elliptical Tops

Corian Top

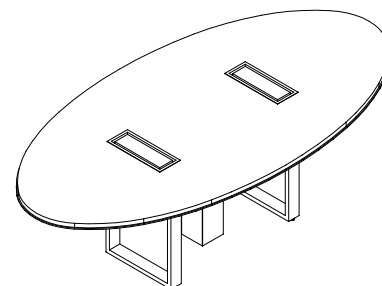

D	W	Pattern No.	CS01 Top	PM01/ PM02 Edge Upcharge	PM03 Edge Upcharge	AU__ Edge Upcharge	PM01/ PM02 Base Upcharge	PM03 Base Upcharge
48"	96"	02E48X96	\$26,801	\$1,790	\$3,990	\$2,535	\$387	\$759
48"	108"	02E48X108	28,524	1,790	4,578	2,770	387	759
48"	120"	02E48X120	30,874	1,812	4,529	3,007	387	759
60"	132"	02E60X132	38,986	2,147	5,491	3,398	387	759
60"	144"	02E60X144	42,669	2,147	5,491	3,637	581	1,138
60"	156"	02E60X156	45,013	2,148	5,492	3,876	581	1,138
60"	168"	02E60X168	48,290	2,183	5,492	4,116	581	1,138
72"	180"	02E72X180	59,133	2,244	5,556	4,502	572	1,394
72"	192"	02E72X192	63,086	2,722	7,134	4,743	572	1,394
72"	204"	02E72X204	65,999	2,722	7,134	4,985	572	1,394
72"	216"	02E72X216	69,627	2,722	7,134	5,226	572	1,394
72"	228"	02E72X228	71,986	2,770	7,181	5,471	572	1,394
72"	240"	02E72X240	76,228	2,770	7,181	5,716	572	1,394

Order Code	Specification Information	Refer To Accessories Section	Pricing Tiers
Example: 02E48X96-CS01-PM01-MC01-GM2-MC01-UCO	To order please specify pattern number including:	Please refer to Accessories section, page 211 for power details.	Please refer to Materials and Finish page 7 for specification details.
02 Highline Collection	1. Top finish	Grommet options available in these finishes:	T1 and T2 pricing includes powder coated base finish.
E Elliptical	2. Trim Finish (only applies if trim type is metal or leather)	Powder coated	There is an upcharge for plated base finishes as highlighted above.
48 Depth	3. Base finish	Premium (Polished Chrome, Satin Nickel or Oil Rubbed Bronze)	For additional stone options and pricing please contact your sales representative."
96 Width	4. Grommet option	Power Box Options	
CS01 Top Finish	5. Grommet finish (only applies if grommets are selected)	Code: Description:	
PM01 Trim Finish	6. Power box option	NP No Power	
MC01 Base Finish	7. Table-top power finish (only applies if table-top power is selected)	UCO Undermount	
GM2 Grommet Opt.	Trim Type	ECO Table Top Lid	
MC01 Grommet Finish	N = No trim	T1E Tabletop 1-Sided Lid	
UCO Undermount	M = Metal (available in Premium and Powder Coat finishes)	T2C Tabletop 2-Sided Lid	
	L = Leather	Must select Wire Management Column and Finish:	
		Powder coated	
		Premium (Polished Chrome, Satin Nickel or Oil Rubbed Bronze)	

Boat Conference Tables

48"-72" Deep Tops

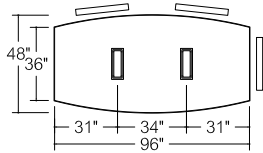
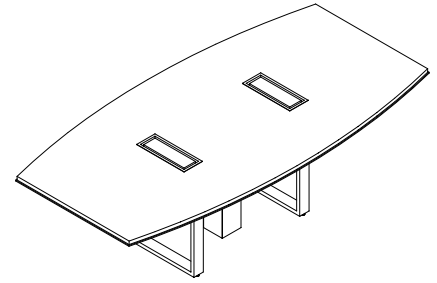

O2B48X96
6 Person Table

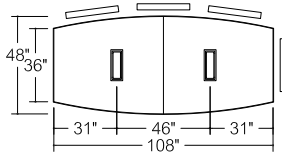

O2B48X108
8 Person Table

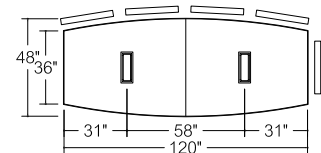

O2B48X120
10 Person Table

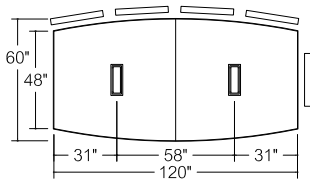

O2B60X120
10 Person Table

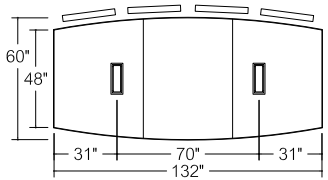

O2B60X132
10 Person Table

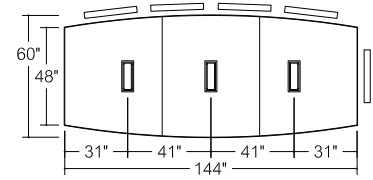

O2B60X144
10 Person Table

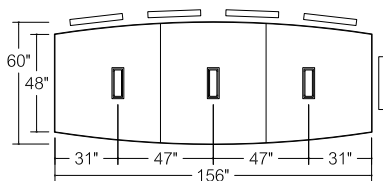

O2B60X156
10 Person Table

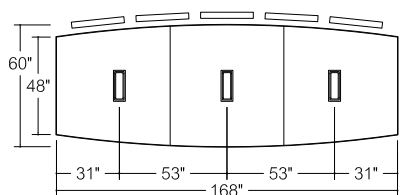

O2B60X168
12 Person Table

Boat Conference Tables

48"-72" Deep Tops

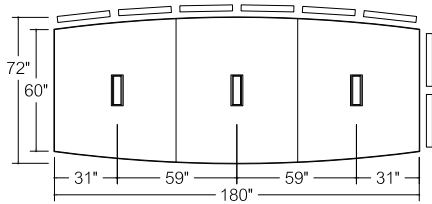
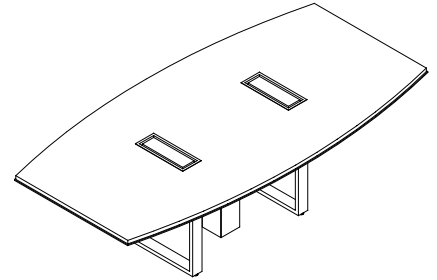

02B72X180

16 Person Table

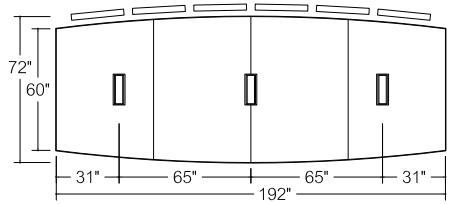

02B72X192

16 Person Table

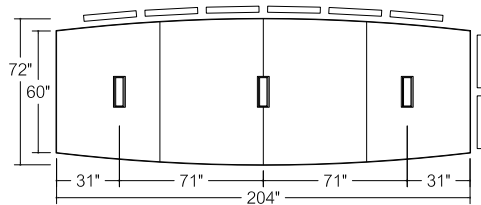

02B72X204

16 Person Table

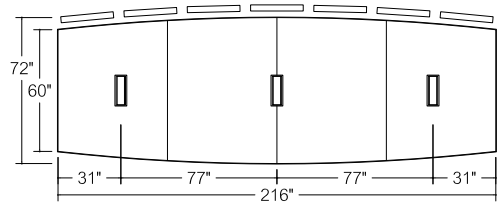

02B72X216

18 Person Table

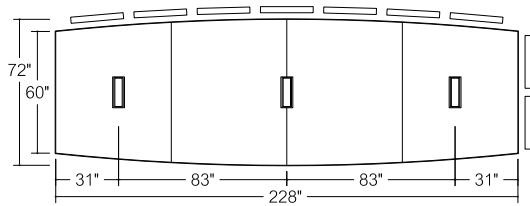

02B72X228

18 Person Table

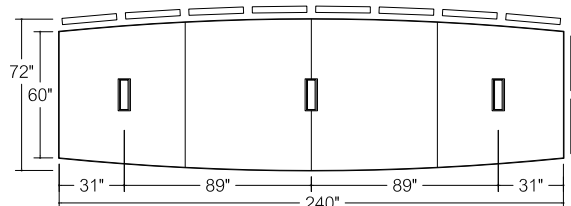

02B72X240

20 Person Table

Boat Conference Tables

48"-72" Deep Boat Tops

Veneer Top

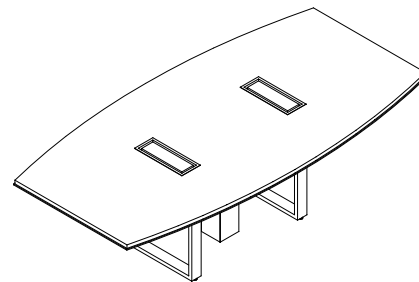

D	W	Pattern No.	T1__ Top	T2__ Top	PM01/ PM02 Edge Upcharge	PM03 Edge Upcharge	AU__ Edge Upcharge	PM01/ PM02 Base Upcharge	PM03 Base Upcharge
48"	96"	02B48X96	\$18,799	\$19,685	\$2,170	\$5,491	\$2,904	\$387	\$759
48"	108"	02B48X108	19,354	20,352	2,170	5,492	3,162	387	759
48"	120"	02B48X120	20,560	21,667	2,179	5,503	3,418	387	759
60"	120"	02B60X120	20,796	22,182	2,179	5,503	3,678	368	1,271
60"	132"	02B60X132	24,428	25,949	2,934	7,322	3,937	368	1,271
60"	144"	02B60X144	27,344	29,004	2,863	7,322	4,196	552	1,905
60"	156"	02B60X156	28,245	30,045	2,862	7,321	4,454	552	1,905
72"	168"	02B60X168	30,078	32,015	2,898	7,322	4,715	552	1,905
72"	180"	02B72X180	35,859	38,350	2,910	7,322	5,231	552	1,905
72"	192"	02B72X192	37,854	40,511	3,415	8,931	5,492	552	1,905
72"	204"	02B72X204	39,023	41,847	3,415	8,931	5,751	552	1,905
72"	216"	02B72X216	40,918	43,907	3,415	8,978	6,010	552	1,905
72"	228"	02B72X228	41,544	44,700	3,462	8,978	6,268	552	1,905
72"	240"	02B72X240	44,053	47,400	3,462	8,978	6,529	552	1,905

Order Code	Specification Information	Refer To Accessories Section	Pricing Tiers
Example: 02B48X96-T003-PM01-MC01-GM2-MC01-UCO	To order please specify pattern number including:	Please refer to Accessories section, page 211 for power details.	Please refer to Materials and Finish page 7 for specification details.
02 Highline Collection	1. Top finish	Grommet options available in these finishes:	T1 and T2 pricing includes powder coated base finish.
B Boat Shaped	2. Trim Finish (only applies if trim type is metal or leather)	Powder coated	There is an upcharge for plated base finishes as highlighted above.
48 Depth	3. Base finish	Premium (Polished Chrome, Satin Nickel or Oil Rubbed Bronze)	For additional stone options and pricing please contact your sales representative."
96 Width	4. Grommet option	Power Box Options	
T003 Top Finish	5. Grommet finish (only applies if grommets are selected)	Code: Description:	
PM01 Trim Finish	6. Power box option	NP No Power	
MC01 Base Finish	7. Table-top power finish (only applies if table-top power is selected)	UCO Undermount	
GM2 Grommet Opt.	Trim Type	ECO Table Top Lid	
MC01 Grommet Finish	N = No trim	T1E Tabletop 1-Sided Lid	
UCO Undermount	M = Metal (available in Premium and Powder Coat finishes)	T2C Tabletop 2-Sided Lid	
	L = Leather	Must select Wire Management Column and Finish:	
		Powder coated	
		Premium (Polished Chrome, Satin Nickel or Oil Rubbed Bronze)	

Boat Conference Tables

48"-72" Deep Boat Tops

Glass Top

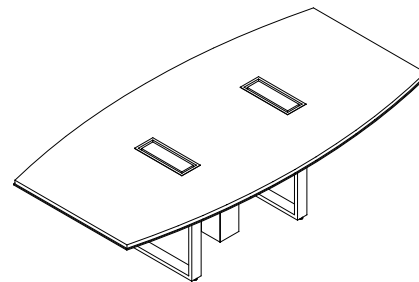

D	W	Pattern No.	GC__ Top	GE__ Top	PM01/ PM02 Edge Upcharge	PM03 Edge Upcharge	AU__ Edge Upcharge	PM01/ PM02 Base Upcharge	PM03 Base Upcharge
48"	96"	02B48X96	\$25,614	\$26,818	\$2,170	\$5,491	\$2,904	\$387	\$759
48"	108"	02B48X108	26,946	28,301	2,170	5,492	3,162	387	759
48"	120"	02B48X120	28,956	30,461	2,179	5,503	3,418	387	759
60"	120"	02B60X120	31,083	32,965	2,179	5,503	3,678	368	1,271
60"	132"	02B60X132	35,807	37,877	2,934	7,322	3,937	368	1,271
60"	144"	02B60X144	39,788	42,047	2,863	7,322	4,196	552	1,905
60"	156"	02B60X156	41,669	44,114	2,862	7,321	4,454	552	1,905
72"	168"	02B60X168	44,519	47,154	2,898	7,322	4,715	552	1,905
72"	180"	02B72X180	54,309	57,695	2,910	7,322	5,231	552	1,905
72"	192"	02B72X192	57,517	61,130	3,415	8,931	5,492	552	1,905
72"	204"	02B72X204	59,864	63,702	3,415	8,931	5,751	552	1,905
72"	216"	02B72X216	62,968	67,033	3,415	8,978	6,010	552	1,905
72"	228"	02B72X228	64,749	69,040	3,462	8,978	6,268	552	1,905
72"	240"	02B72X240	68,494	73,010	3,462	8,978	6,529	552	1,905

Order Code	Specification Information	Refer To Accessories Section	Pricing Tiers
Example: 02B48X96-GE01-PM01-MC01-GM2-MC01-UCO	To order please specify pattern number including:	Please refer to Accessories section, page 211 for power details.	Please refer to Materials and Finish page 7 for specification details.
02 Highline Collection	1. Top finish	Grommet options available in these finishes:	T1 and T2 pricing includes powder coated base finish.
B Boat Shaped	2. Trim Finish (only applies if trim type is metal or leather)	Powder coated	There is an upcharge for plated base finishes as highlighted above.
48 Depth	3. Base finish	Premium (Polished Chrome, Satin Nickel or Oil Rubbed Bronze)	For additional stone options and pricing please contact your sales representative."
96 Width	4. Grommet option	Power Box Options	
GE01 Top Finish	5. Grommet finish (only applies if grommets are selected)	Code: Description:	
PM01 Trim Finish	6. Power box option	NP No Power	
MC01 Base Finish	7. Table-top power finish (only applies if table-top power is selected)	UCO Undermount	
GM2 Grommet Opt.	Trim Type	ECO Table Top Lid	
MC01 Grommet Finish	N = No trim	T1E Tabletop 1-Sided Lid	
UCO Undermount	M = Metal (available in Premium and Powder Coat finishes)	T2C Tabletop 2-Sided Lid	
	L = Leather	Must select Wire Management Column and Finish:	
		Powder coated	
		Premium (Polished Chrome, Satin Nickel or Oil Rubbed Bronze)	

Boat Conference Tables

48"-72" Deep Boat Tops

Corian Top

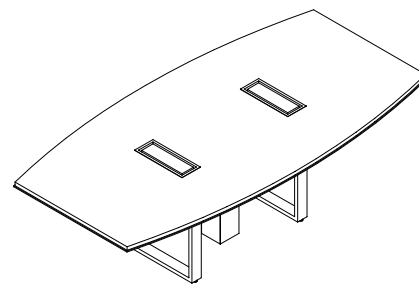

D	W	Pattern No.	CS01 Top	PM01/ PM02 Edge Upcharge	PM03 Edge Upcharge	AU__ Edge Upcharge	PM01/ PM02 Base Upcharge	PM03 Base Upcharge
48"	96"	02B48X96	\$28,042	\$2,170	\$5,491	\$2,904	\$387	\$759
48"	108"	02B48X108	29,754	2,170	5,492	3,162	387	759
48"	120"	02B48X120	32,114	2,179	5,503	3,418	387	759
60"	120"	02B60X120	35,238	2,179	5,503	3,678	368	1,271
60"	132"	02B60X132	40,313	2,934	7,322	3,937	368	1,271
60"	144"	02B60X144	44,675	2,863	7,322	4,196	552	1,905
60"	156"	02B60X156	47,020	2,862	7,321	4,454	552	1,905
72"	168"	02B60X168	50,297	2,898	7,322	4,715	552	1,905
72"	180"	02B72X180	61,855	2,910	7,322	5,231	552	1,905
72"	192"	02B72X192	65,584	3,415	8,931	5,492	552	1,905
72"	204"	02B72X204	68,484	3,415	8,931	5,751	552	1,905
72"	216"	02B72X216	72,114	3,415	8,978	6,010	552	1,905
72"	228"	02B72X228	74,472	3,462	8,978	6,268	552	1,905
72"	240"	02B72X240	78,715	3,462	8,978	6,529	552	1,905

Order Code	Specification Information	Refer To Accessories Section	Pricing Tiers
Example: 02B48X96-CS01-PM01-MC01-GM2-MC01-UCO	To order please specify pattern number including:	Please refer to Accessories section, page 211 for power details.	Please refer to Materials and Finish page 7 for specification details.
02 Highline Collection	1. Top finish	Grommet options available in these finishes:	T1 and T2 pricing includes powder coated base finish.
B Boat Shaped	2. Trim Finish (only applies if trim type is metal or leather)	Powder coated	There is an upcharge for plated base finishes as highlighted above.
48 Depth	3. Base finish	Premium (Polished Chrome, Satin Nickel or Oil Rubbed Bronze)	For additional stone options and pricing please contact your sales representative."
96 Width	4. Grommet option	Power Box Options	
CS01 Top Finish	5. Grommet finish (only applies if grommets are selected)	Code: Description:	
PM01 Trim Finish	6. Power box option	NP No Power	
MC01 Base Finish	7. Table-top power finish (only applies if table-top power is selected)	UCO Undermount	
GM2 Grommet Opt.	Trim Type	ECO Table Top Lid	
MC01 Grommet Finish	N = No trim	T1E Tabletop 1-Sided Lid	
UCO Undermount	M = Metal (available in Premium and Powder Coat finishes)	T2C Tabletop 2-Sided Lid	
	L = Leather	Must select Wire Management Column and Finish:	
		Powder coated	
		Premium (Polished Chrome, Satin Nickel or Oil Rubbed Bronze)	

Trapezoid Conference Tables

48"-72" Deep Tops

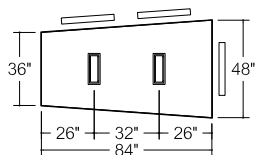
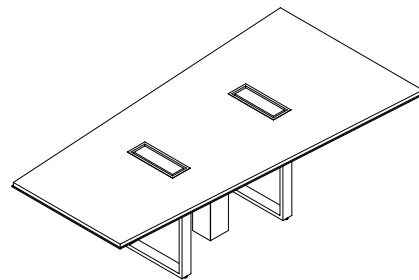

02T48X84
6 Person Table

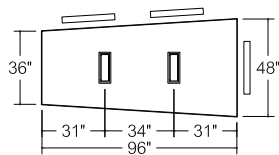

02T48X96
6 Person Table

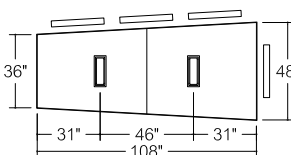

02T48X108
8 Person Table

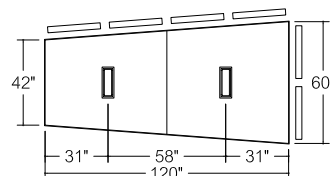

02T60X120
11 Person Table

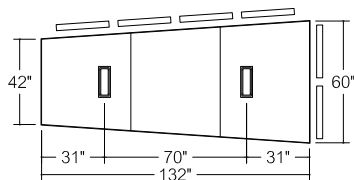

02T60X132
11 Person Table

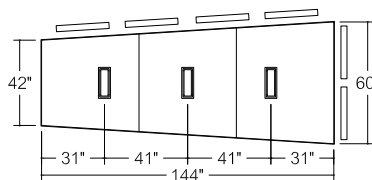

02T60X144
11 Person Table

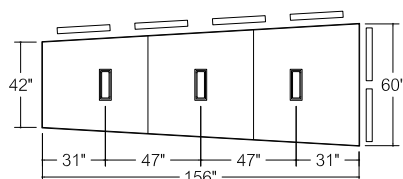

02T60X156
13 Person Table

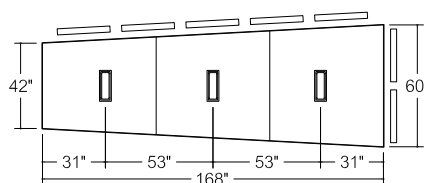

02T60X168
13 Person Table

Trapezoid Conference Tables

48"-72" Deep Tops

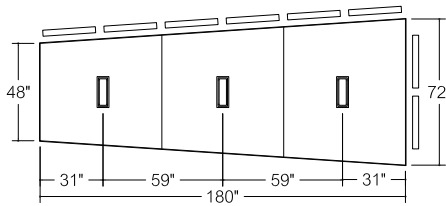
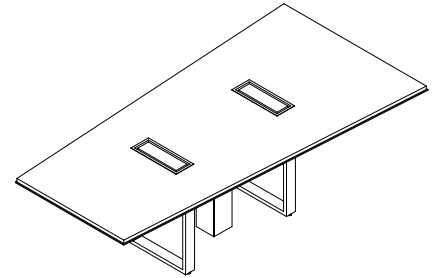

02T72X180
15 Person Table

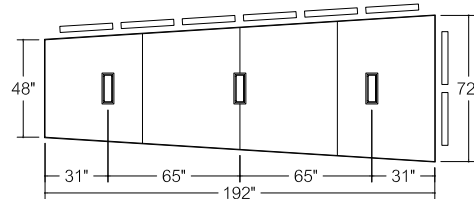

02T72X192
15 Person Table

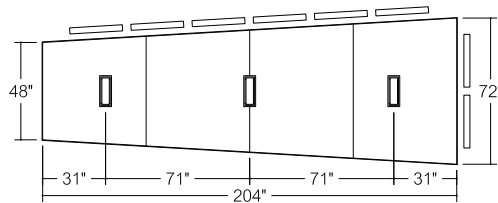

02T72X204
15 Person Table

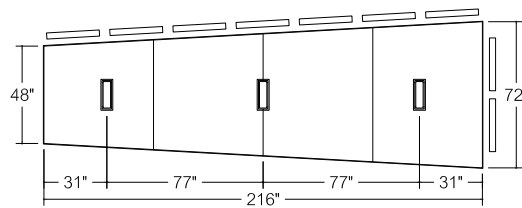

02T72X216
17 Person Table

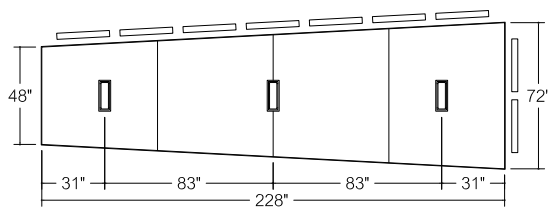

02T72X228
17 Person Table

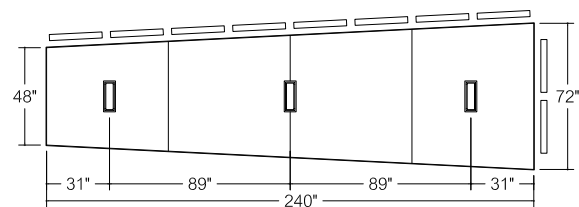

02T72X240
19 Person Table

Trapezoid Conference Tables

48"-72" Deep Trapezoid Tops

Veneer Top

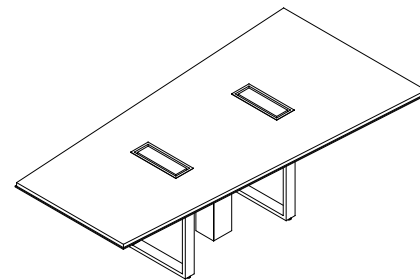

D	W	Pattern No.	T1__ Top	T2__ Top	PM01/ PM02 Edge Upcharge	PM03 Edge Upcharge	AU__ Edge Upcharge	PM01/ PM02 Base Upcharge	PM03 Base Upcharge
48"	84"	02T48X84	\$12,216	\$12,992	\$940	\$940	\$2,177	\$387	\$759
48"	96"	02T48X96	13,110	13,993	940	940	2,384	387	759
48"	108"	02T48X108	13,583	14,580	940	940	2,590	387	759
60"	120"	02T60X120	16,904	18,289	792	792	2,956	387	759
60"	132"	02T60X132	20,370	21,893	1,155	1,155	3,161	387	759
60"	144"	02T60X144	21,378	23,039	1,155	1,155	3,369	581	1,138
60"	156"	02T60X156	21,905	23,704	1,155	1,155	3,576	581	1,138
72"	168"	02T60X168	23,354	25,291	1,883	1,883	3,781	581	1,138
72"	180"	02T72X180	27,776	30,266	1,882	1,882	4,147	581	1,138
72"	192"	02T72X192	28,808	31,465	1,882	1,882	4,353	581	1,138
72"	204"	02T72X204	29,654	32,477	1,882	1,882	4,560	581	1,138
72"	216"	02T72X216	30,512	33,501	1,882	1,882	4,767	581	1,138
72"	228"	02T72X228	31,339	34,495	1,882	1,882	4,974	581	1,138
72"	240"	02T72X240	32,191	35,513	1,882	1,882	5,179	581	1,138

Order Code	Specification Information	Refer To Accessories Section	Pricing Tiers
Example: 02T48X96-T003-PM01-MC01-GM2-MC01-UCO	To order please specify pattern number including:	Please refer to Accessories section, page 211 for power details.	Please refer to Materials and Finish page 7 for specification details.
02 Highline Collection	1. Top finish	Grommet options available in these finishes:	T1 and T2 pricing includes powder coated base finish.
T142 Trapezoid	2. Trim Finish (only applies if trim type is metal or leather)	Powder coated	There is an upcharge for plated base finishes as highlighted above.
48 Depth	3. Base finish	Premium (Polished Chrome, Satin Nickel or Oil Rubbed Bronze)	For additional stone options and pricing please contact your sales representative."
96 Width	4. Grommet option	Power Box Options	
T003 Top Finish	5. Grommet finish (only applies if grommets are selected)	Code: Description:	
PM01 Trim Finish	6. Power box option	NP No Power	
MC01 Base Finish	7. Table-top power finish (only applies if table-top power is selected)	UCO Undermount	
GM2 Grommet Opt.	Trim Type	ECO Table Top Lid	
MC01 Grommet Finish	N = No trim	T1E Tabletop 1-Sided Lid	
UCO Undermount	M = Metal (available in Premium and Powder Coat finishes)	T2C Tabletop 2-Sided Lid	
	L = Leather	Must select Wire Management Column and Finish:	
		Powder coated	
		Premium (Polished Chrome, Satin Nickel or Oil Rubbed Bronze)	

Trapezoid Conference Tables

48"-72" Deep Trapezoid Tops

Glass Top

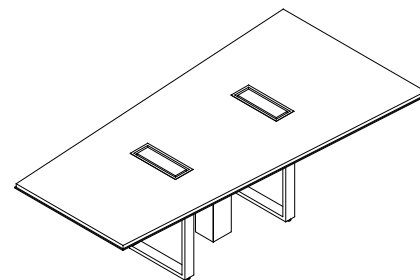

D	W	Pattern No.	GC__ Top	GE__ Top	PM01/	PM01/	PM01/	PM01/	PM01/
					PM02 Edge	PM03 Edge	AU__ Edge	PM02 Base	PM03 Base
					Upcharge	Upcharge	Upcharge	Upcharge	Upcharge
48"	84"	02T48X84	\$18,000	\$19,055	\$940	\$940	\$2,177	\$387	\$759
48"	96"	02T48X96	19,684	20,887	940	940	2,384	387	759
48"	108"	02T48X108	20,931	22,286	940	940	2,590	387	759
60"	120"	02T60X120	27,026	28,908	792	792	2,956	387	759
60"	132"	02T60X132	31,579	33,648	1,155	1,155	3,161	387	759
60"	144"	02T60X144	33,571	35,829	1,155	1,155	3,369	581	1,138
60"	156"	02T60X156	35,061	37,507	1,155	1,155	3,576	581	1,138
72"	168"	02T60X168	37,511	40,144	1,883	1,883	3,781	581	1,138
72"	180"	02T72X180	45,883	49,271	1,882	1,882	4,147	581	1,138
72"	192"	02T72X192	48,088	51,701	1,882	1,882	4,353	581	1,138
72"	204"	02T72X204	50,099	53,937	1,882	1,882	4,560	581	1,138
72"	216"	02T72X216	52,122	56,186	1,882	1,882	4,767	581	1,138
72"	228"	02T72X228	54,114	58,403	1,882	1,882	4,974	581	1,138
72"	240"	02T72X240	56,130	60,645	1,882	1,882	5,179	581	1,138

Order Code	Specification Information	Refer To Accessories Section	Pricing Tiers
Example: 02T48X96-GE01-PM01-MC01-GM2-MC01-UCO	To order please specify pattern number including:	Please refer to Accessories section, page 211 for power details.	Please refer to Materials and Finish page 7 for specification details.
02 Highline Collection	1. Top finish	Grommet options available in these finishes:	T1 and T2 pricing includes powder coated base finish.
T Trapezoid	2. Trim Finish (only applies if trim type is metal or leather)	Powder coated	There is an upcharge for plated base finishes as highlighted above.
48 Depth	3. Base finish	Premium (Polished Chrome, Satin Nickel or Oil Rubbed Bronze)	For additional stone options and pricing please contact your sales representative."
96 Width	4. Grommet option	Power Box Options	
GE01 Top Finish	5. Grommet finish (only applies if grommets are selected)	Code: Description:	
PM01 Trim Finish	6. Power box option	NP No Power	
MC01 Base Finish	7. Table-top power finish (only applies if table-top power is selected)	UCO Undermount	
GM2 Grommet Opt.	Trim Type	ECO Table Top Lid	
MC01 Grommet Finish	N = No trim	T1E Tabletop 1-Sided Lid	
UCO Undermount	M = Metal (available in Premium and Powder Coat finishes)	T2C Tabletop 2-Sided Lid	
	L = Leather	Must select Wire Management Column and Finish:	
		Powder coated	
		Premium (Polished Chrome, Satin Nickel or Oil Rubbed Bronze)	

Trapezoid Conference Tables

48"-72" Deep Trapezoid Tops

Corian Top

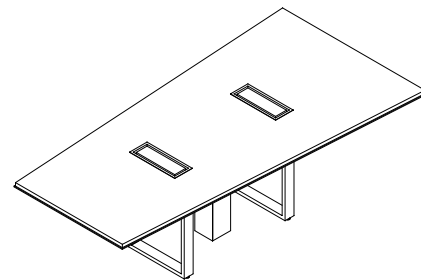

D	W	Pattern No.	CS01 Top	PM01/ PM02 Edge Upcharge	PM03 Edge Upcharge	AU__ Edge Upcharge	PM01/ PM02 Base Upcharge	PM03 Base Upcharge
48"	84"	02T48X84	\$20,304	\$940	\$940	\$2,177	\$387	\$759
48"	96"	02T48X96	22,352	940	940	2,384	387	759
48"	108"	02T48X108	23,981	940	940	2,590	387	759
60"	120"	02T60X120	31,346	792	792	2,956	387	759
60"	132"	02T60X132	36,256	1,155	1,155	3,161	387	759
60"	144"	02T60X144	38,709	1,155	1,155	3,369	581	1,138
60"	156"	02T60X156	40,680	1,155	1,155	3,576	581	1,138
72"	168"	02T60X168	43,572	1,883	1,883	3,781	581	1,138
72"	180"	02T72X180	53,773	1,882	1,882	4,147	581	1,138
72"	192"	02T72X192	56,536	1,882	1,882	4,353	581	1,138
72"	204"	02T72X204	59,116	1,882	1,882	4,560	581	1,138
72"	216"	02T72X216	61,707	1,882	1,882	4,767	581	1,138
72"	228"	02T72X228	64,269	1,882	1,882	4,974	581	1,138
72"	240"	02T72X240	66,853	1,882	1,882	5,179	581	1,138

Order Code	Specification Information	Refer To Accessories Section	Pricing Tiers
Example: 02T48X96-CS01-PM01-MC01-GM2-MC01-UCO	To order please specify pattern number including:	Please refer to Accessories section, page 211 for power details.	Please refer to Materials and Finish page 7 for specification details.
02 Highline Collection	1. Top finish	Grommet options available in these finishes:	T1 and T2 pricing includes powder coated base finish.
T Trapezoid	2. Trim Finish (only applies if trim type is metal or leather)	Powder coated	There is an upcharge for plated base finishes as highlighted above.
48 Depth	3. Base finish	Premium (Polished Chrome, Satin Nickel or Oil Rubbed Bronze)	For additional stone options and pricing please contact your sales representative."
96 Width	4. Grommet option	Power Box Options	
CS01 Top Finish	5. Grommet finish (only applies if grommets are selected)	Code: Description:	
PM01 Trim Finish	6. Power box option	NP No Power	
MC01 Base Finish	7. Table-top power finish (only applies if table-top power is selected)	UCO Undermount	
GM2 Grommet Opt.	Trim Type	ECO Table Top Lid	
MC01 Grommet Finish	N = No trim	T1E Tabletop 1-Sided Lid	
UCO Undermount	M = Metal (available in Premium and Powder Coat finishes)	T2C Tabletop 2-Sided Lid	
	L = Leather	Must select Wire Management Column and Finish:	
		Powder coated	
		Premium (Polished Chrome, Satin Nickel or Oil Rubbed Bronze)	

Highline Collection

Highline Meeting Tables



DATESWEISER

General Specifications

Highline Meeting Tables

Overall Elevations and Clearance

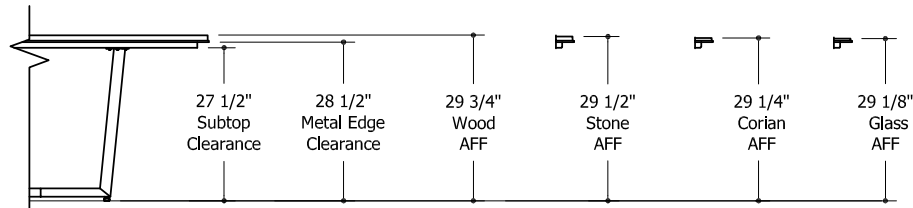

Round Table Layouts

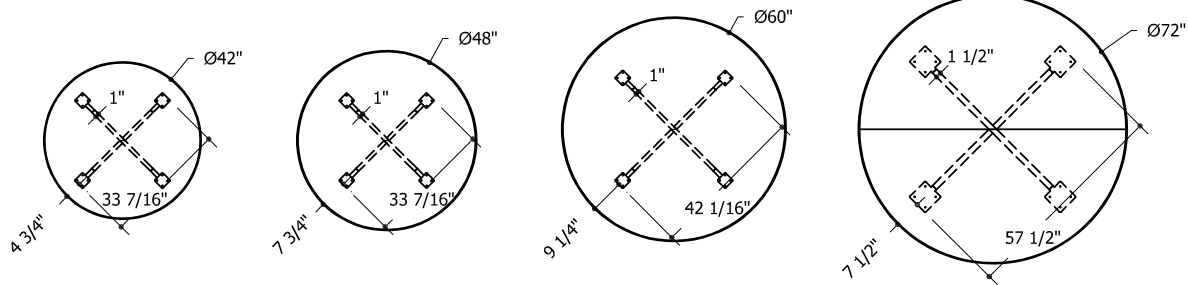

Square Table Layouts

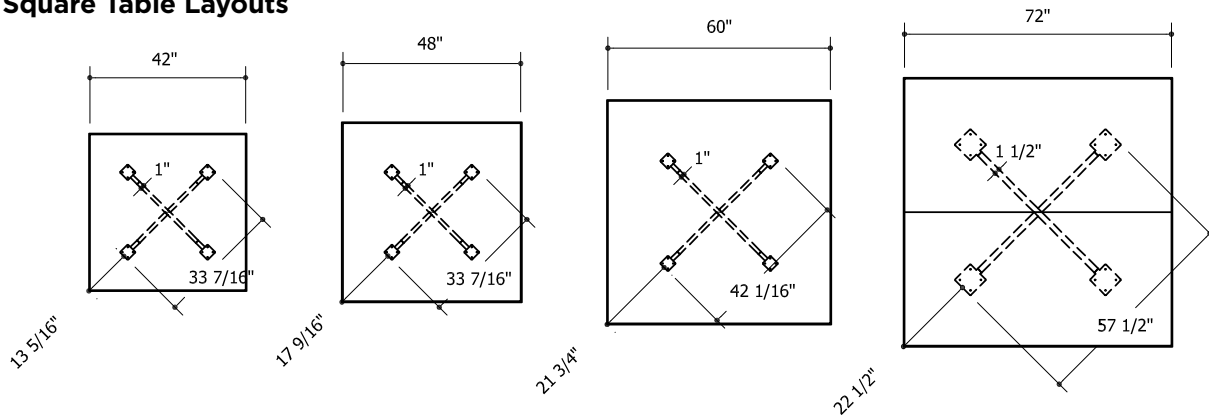

Elliptical Table Layouts

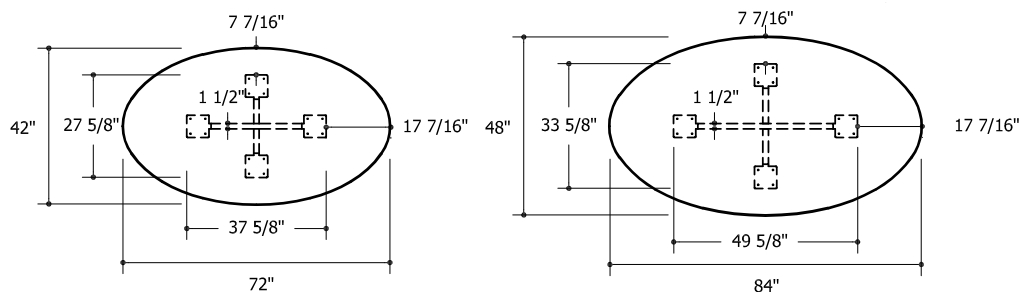

General Specifications

Highline Meeting Tables

Top Construction

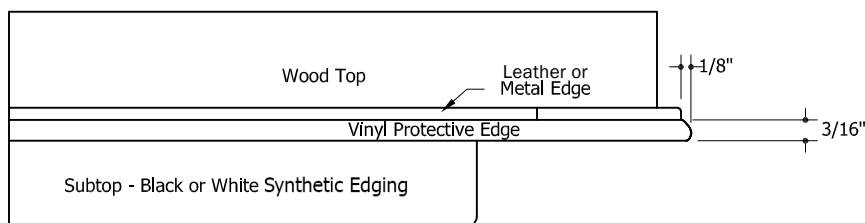
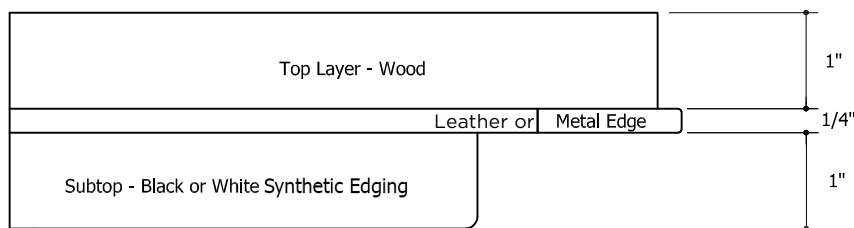
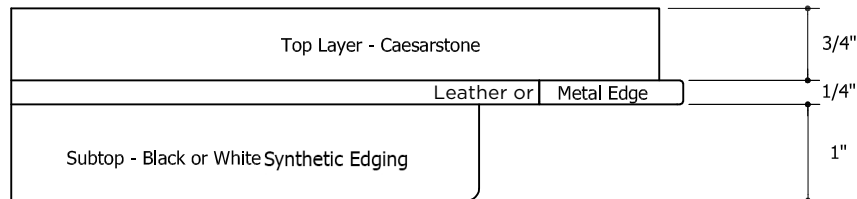
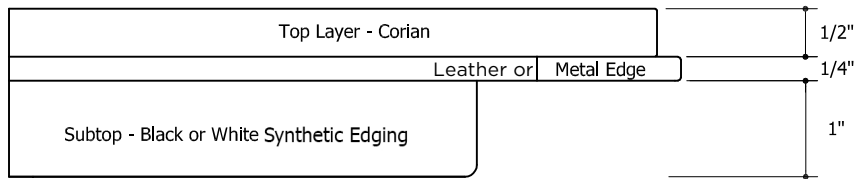
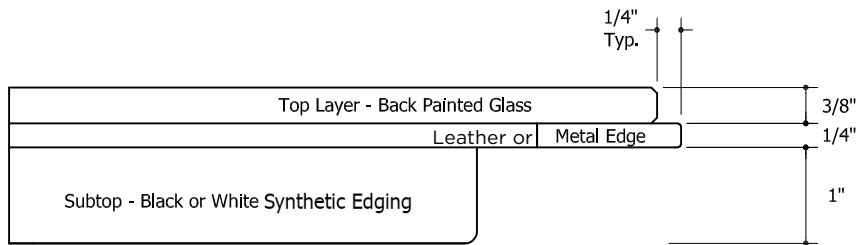

General Specifications

Highline Meeting Tables

Base Construction

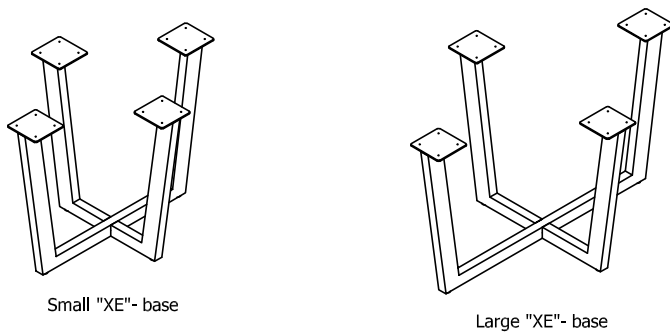
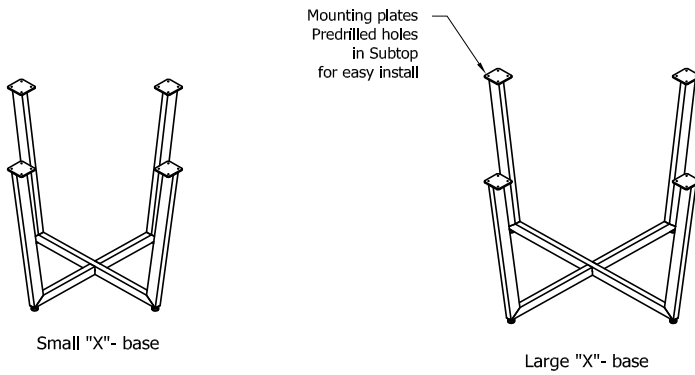

Construction

- Tubular steel "X" base
- Small "X" base: 42" / 48" Round and Square meeting tables
- Large "X" base: 60" / 72" Round and Square meeting tables

- Small "XE" base: 42" Elliptical meeting tables
- Large "XE" base: 48" Elliptical meeting tables

- "XP" Wire Management base is automatically included when power and connectivity are specified on Square and Round meeting tables
- "XEP" Wire Management base is automatically included used when power and connectivity are specified on Elliptical meeting tables

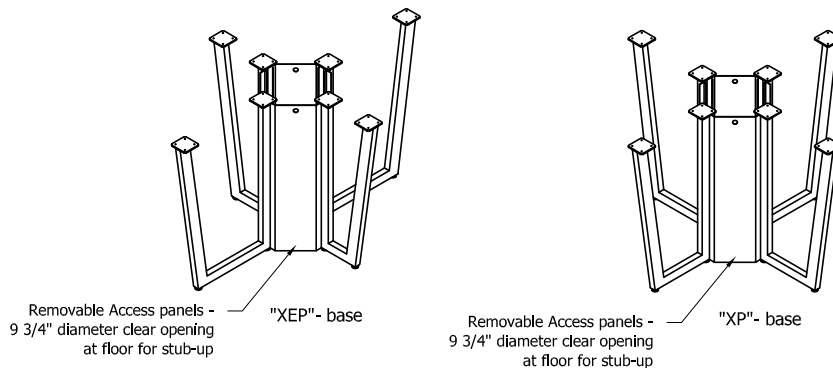

General Specifications

Highline Meeting Tables

Dual Flip Table Top Power & Connectivity Layout

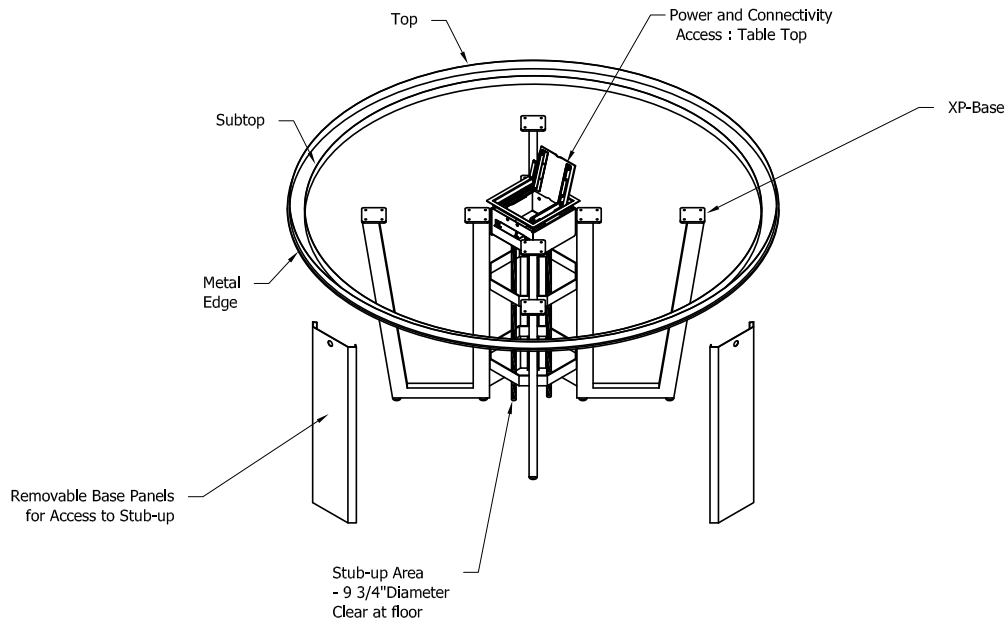

For Meeting Tables

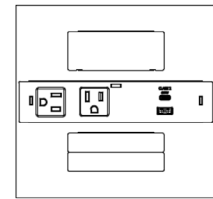
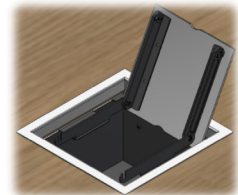

Double-Sided Meeting Table Topmount

Undermount/edgemount Power & Connectivity Layout

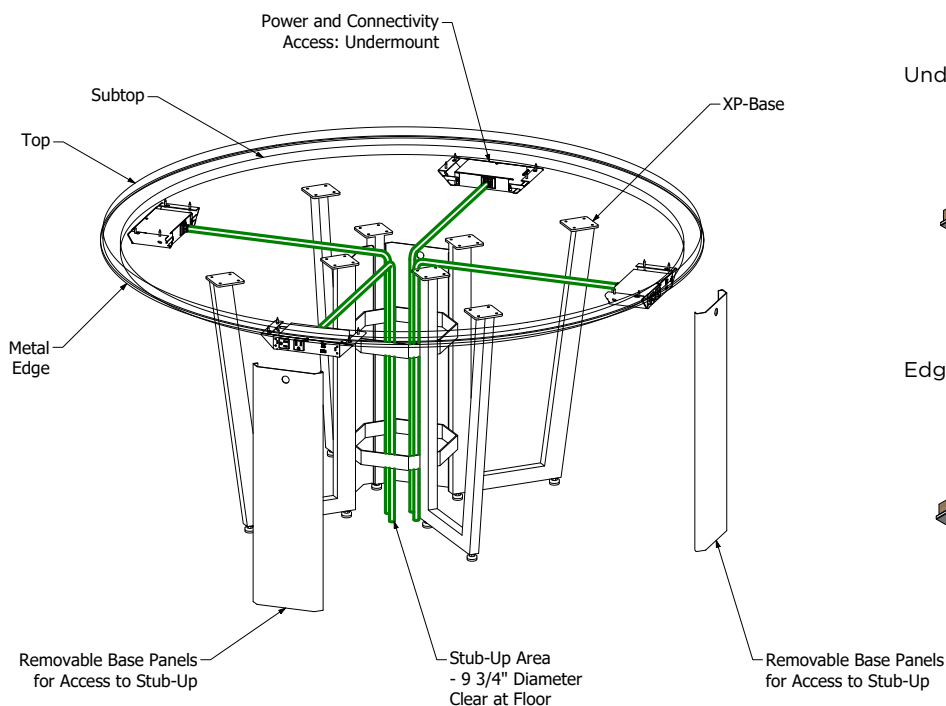

Undermount Power

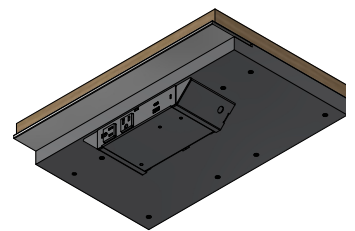

Edgemount Power

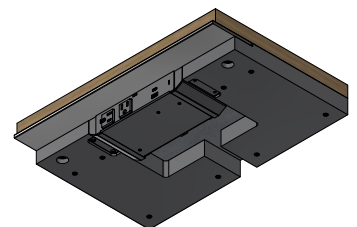

Highline Meeting Tables

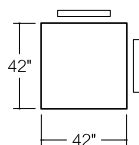
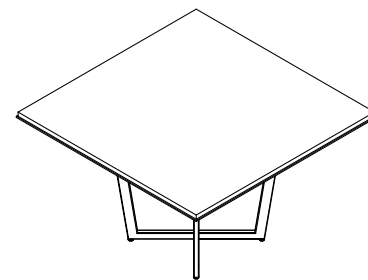

02M42S
4 Person Table

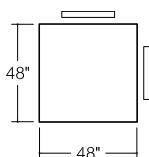

02M48S
4 Person Table

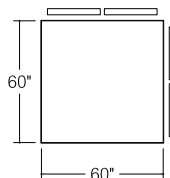

02M60S
8 Person Table

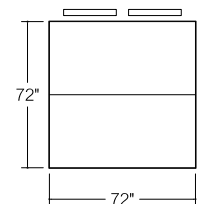

02M72S
8 Person Table

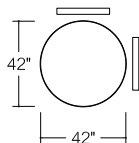

02M42C
4 Person Table

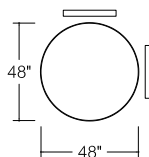

02M48C
4 Person Table

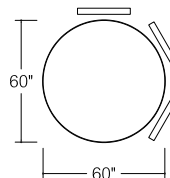

02M60C
6 Person Table

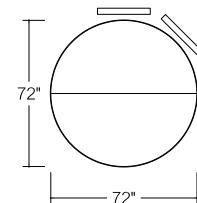

02M72C
8 Person Table

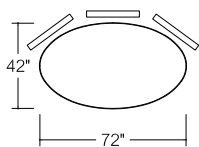

02M42E
6 Person Table

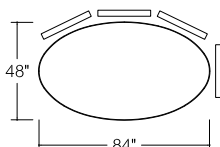

02M48E
8 Person Table

Highline Meeting Tables

Square, Round & Elliptical Meeting Tables

Veneer Top

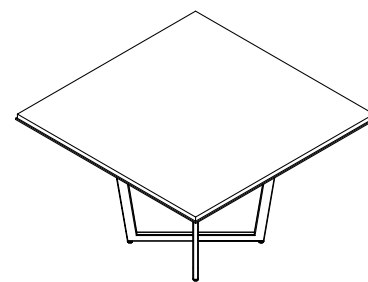

Dimension	Pattern No.	T1__ Top	T2__ Top	PM01/ PM02 Edge Upcharge	PM03 Edge Upcharge	AU__ Edge Upcharge	PM01/ PM02 Base Upcharge	PM03 Base Upcharge
42"x42"	02M42S	\$8,403	\$8,742	\$1,431	\$3,661	\$1,448	\$507	\$2,957
48"x48"	02M48S	8,920	9,361	1,467	3,661	1,656	507	2,957
60"x60"	02M60S	11,167	11,859	1,454	3,661	2,069	507	2,957
72"x72"	02M72S	12,981	13,978	1,244	3,331	2,484	507	2,957
42"D	02M42C	11,011	11,351	352	2,160	1,429	507	2,957
48"D	02M48C	11,532	11,975	352	2,160	1,633	507	2,957
60"D	02M60C	14,927	15,619	285	2,113	2,042	507	2,957
72"D	02M72C	16,579	17,564	285	2,113	2,451	507	2,957
42"x72"	02M42E	15,623	16,204	537	2,344	1,990	507	2,957
48"x84"	02M48E	16,851	17,627	774	2,182	2,305	507	2,957

Power X Base Upcharges

Pattern No.	Size	Description	LIST
WM	48"D, 60"D	Small Power X Base	\$8,820
WM	72"D and Ellipicals	Large Power X Base	\$9,790

Note: 42"x42" square and 42" diameter tables are not available with power.

Order Code	Specification Information	Refer To Accessories Section	Pricing Tiers
Example: 02M48S-T003-PM01-MC01-GM1-MC01-UCO	To order please specify pattern number including:	Please refer to Accessories section, page 211 for power details.	Please refer to Materials and Finish page 7 for specification details.
02 Highline Collection	1. Top finish	Grommet options available in these finishes:	T1 and T2 pricing includes powder coated base finish.
M Meeting	2. Trim Finish (only applies if trim type is metal or leather)	Powder coated	There is an upcharge for plated base finishes as highlighted above.
48 Depth	3. Base finish	Premium (Polished Chrome, Satin Nickel or Oil Rubbed Bronze)	For additional stone options and pricing please contact your sales representative."
S Square	4. Grommet option	Power Box Options	
T003 Top Finish	5. Grommet finish (only applies if grommets are selected)	Code: Description:	
PM01 Trim Finish	6. Power box option	NP No Power	
MC01 Base Finish	7. Table-top power finish (only applies if table-top power is selected)	UCO Undermount	
GM1 Grommet Opt.	Trim Type	ECO Table Top Lid	
MC01 Grommet Finish	N = No trim	T1E Tabletop 1-Sided Lid	
UCO Undermount	M = Metal (available in Premium and Powder Coat finishes)	T2C Tabletop 2-Sided Lid	
	L = Leather	Must select Wire Management Column and Finish:	
		Powder coated	
		Premium (Polished Chrome, Satin Nickel or Oil Rubbed Bronze)	

Highline Meeting Tables

Square, Round & Elliptical Meeting Tables Glass Top

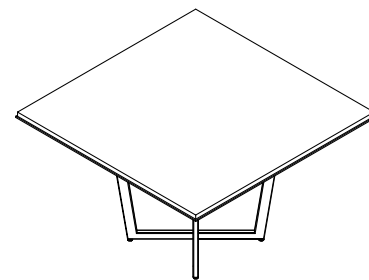

Dimension	Pattern No.	GC__ Top	GE__ Top	PM01/			PM01/	
				PM02 Edge Upcharge	PM03 Edge Upcharge	AU__ Edge Upcharge	PM02 Base Upcharge	PM03 Base Upcharge
42"x42"	02M42S	\$10,280	\$10,587	\$1,431	\$3,661	\$1,448	\$507	\$2,957
48"x48"	02M48S	11,283	11,685	1,467	3,661	1,656	507	2,957
60"x60"	02M60S	14,744	15,371	1,454	3,661	2,069	507	2,957
72"x72"	02M72S	18,000	22,668	1,244	3,331	2,484	507	2,957
42"D	02M42C	13,781	14,280	352	2,160	1,429	507	2,957
48"D	02M48C	15,030	15,631	352	2,160	1,633	507	2,957
60"D	02M60C	20,262	21,202	285	2,113	2,042	507	2,957
72"D	02M72C	24,055	25,409	285	2,113	2,451	507	2,957
42"x72"	02M42E	20,235	21,025	537	2,344	1,990	507	2,957
48"x84"	02M48E	22,832	23,886	774	2,182	2,305	507	2,957

Power X Base Upcharges

Pattern No.	Size	Description	LIST
WM	48"D, 60"D	Small Power X Base	\$8,820
WM	72"D and Ellipticals	Large Power X Base	\$9,790

Note: 42"x42" square and 42" diameter tables are not available with power.

Order Code	Specification Information	Refer To Accessories Section	Pricing Tiers
Example: 02M48S-GE01-PM01-MC01-GM1-MC01-UC0	To order please specify pattern number including:	Please refer to Accessories section, page 211 for power details.	Please refer to Materials and Finish page 7 for specification details.
02 Highline Collection	1. Top finish	Grommet options available in these finishes:	T1 and T2 pricing includes powder coated base finish.
M Meeting	2. Trim Finish (only applies if trim type is metal or leather)	Powder coated	There is an upcharge for plated base finishes as highlighted above.
48 Depth	3. Base finish	Premium (Polished Chrome, Satin Nickel or Oil Rubbed Bronze)	For additional stone options and pricing please contact your sales representative."
S Square	4. Grommet option	Power Box Options	
GE01 Top Finish	5. Grommet finish (only applies if grommets are selected)	Code: Description:	
PM01 Trim Finish	6. Power box option	NP No Power	
MC01 Base Finish	7. Table-top power finish (only applies if table-top power is selected)	UC0 Undermount	
GM1 Grommet Opt.	Trim Type	ECO Table Top Lid	
MC01 Grommet Finish	N = No trim	T1E Tabletop 1-Sided Lid	
UC0 Undermount	M = Metal (available in Premium and Powder Coat finishes)	T2C Tabletop 2-Sided Lid	
	L = Leather	Must select Wire Management Column and Finish:	
		Powder coated	
		Premium (Polished Chrome, Satin Nickel or Oil Rubbed Bronze)	

Highline Meeting Tables

Square, Round & Elliptical Meeting Tables

Corian Top

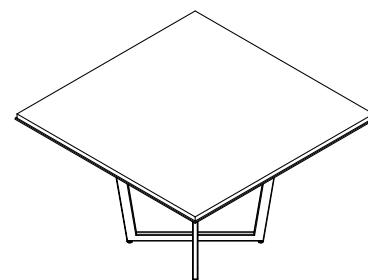

Dimension	Pattern No.	CS01 Top	PM01/ PM02 Edge Upcharge	PM03 Edge Upcharge	AU__ Edge Upcharge	PM01/ PM02 Base Upcharge	PM03 Base Upcharge
42"x42"	02M42S	\$10,541	\$1,431	\$3,661	\$1,448	\$507	\$2,957
48"x48"	02M48S	11,712	1,467	3,661	1,656	507	2,957
60"x60"	02M60S	15,530	1,454	3,661	2,069	507	2,957
72"x72"	02M72S	19,263	1,244	3,331	2,484	507	2,957
42"D	02M42C	14,549	352	2,160	1,429	507	2,957
48"D	02M48C	16,154	352	2,160	1,633	507	2,957
60"D	02M60C	22,148	285	2,113	2,042	507	2,957
72"D	02M72C	26,978	285	2,113	2,451	507	2,957
42"x72"	02M42E	21,688	537	2,344	1,990	507	2,957
48"x84"	02M48E	24,939	774	2,182	2,305	507	2,957

Power X Base Upcharges

Pattern No.	Size	Description	LIST
WM	48"D, 60"D	Small Power X Base	\$8,820
WM	72"D and Ellipticals	Large Power X Base	\$9,790

Note: 42"x42" square and 42" diameter tables are not available with power.

Order Code	Specification Information	Refer To Accessories Section	Pricing Tiers
Example: 02M48S-CS01-PM01-MC01-GM1-MC01-UCO	To order please specify pattern number including:	Please refer to Accessories section, page 211 for power details.	Please refer to Materials and Finish page 7 for specification details.
02 Highline Collection	1. Top finish	Grommet options available in these finishes:	T1 and T2 pricing includes powder coated base finish.
M Meeting	2. Trim Finish (only applies if trim type is metal or leather)	Powder coated	There is an upcharge for plated base finishes as highlighted above.
48 Depth	3. Base finish	Premium (Polished Chrome, Satin Nickel or Oil Rubbed Bronze)	For additional stone options and pricing please contact your sales representative."
S Square	4. Grommet option	Power Box Options	
CS01 Top Finish	5. Grommet finish (only applies if grommets are selected)	Code: Description:	
PM01 Trim Finish	6. Power box option	NP No Power	
MC01 Base Finish	7. Table-top power finish (only applies if table-top power is selected)	UCO Undermount	
GM1 Grommet Opt.	Trim Type	ECO Table Top Lid	
MC01 Grommet Finish	N = No trim	T1E Tabletop 1-Sided Lid	
UCO Undermount	M = Metal (available in Premium and Powder Coat finishes)	T2C Tabletop 2-Sided Lid	
	L = Leather	Must select Wire Management Column and Finish:	
		Powder coated	
		Premium (Polished Chrome, Satin Nickel or Oil Rubbed Bronze)	

Highline Collection

Highline Credenzas



DATESWEISER

General Specifications

Highline Credenzas

Credenza Optional Tops

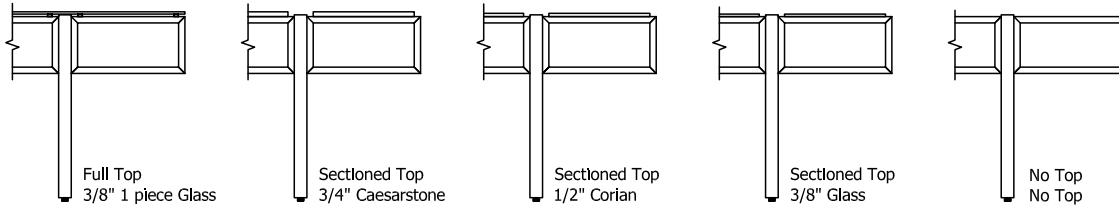

Sectioned Top Plan

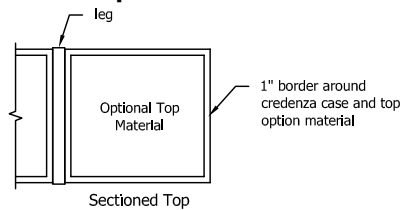

Credenza Elevations

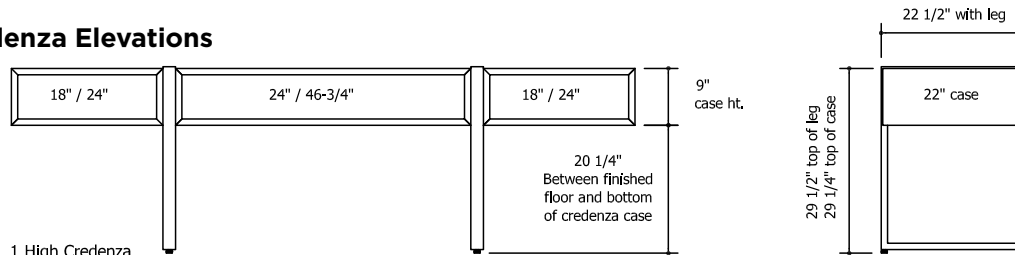

1 High Credenza

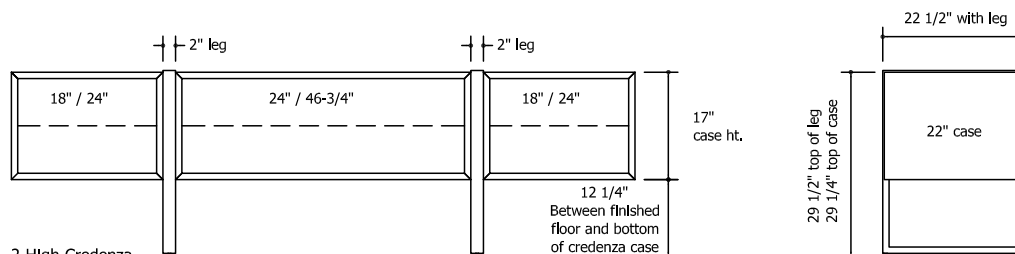

2 High Credenza

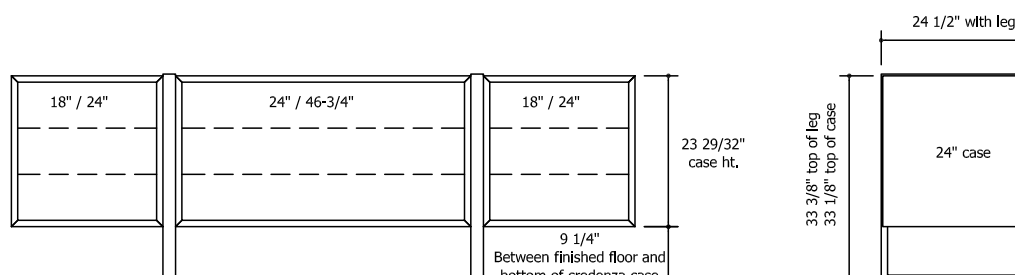

3 High Credenza

General Specifications

Highline Credenzas

Credenza Leg and Case Details

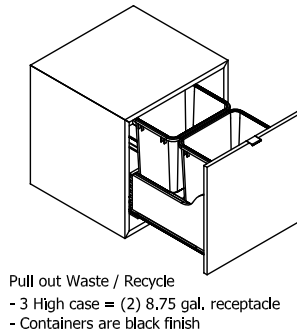
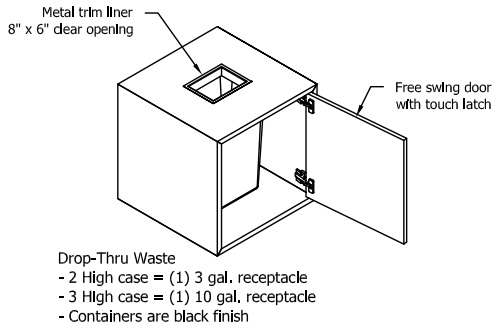
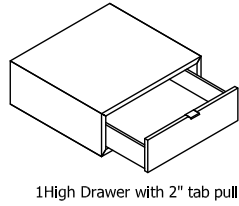
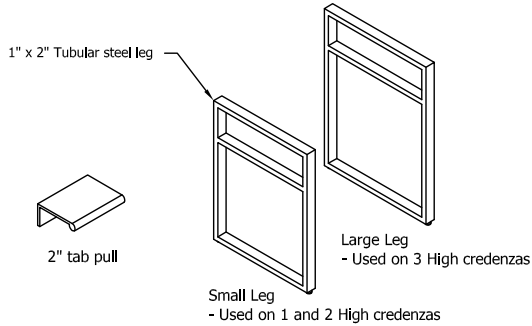

Credenza Notes

- Pulls and trash liners come in the specified metal finish
- All drawers have a 2" tab pull located in the center of the top edge of each drawer front
- All drawers use partial extension, self-closing undermount slides
- Pull-out trash units use full extension side mount slides
- Pull-out trash units are a Rev-A-Shelf product
- All doors use free swing hinges and touch latches
- All credenza top material finishes are secured to the case with silicone except for tops finished with full clear glass
- Full clear glass (FG GC00) rests atop of 3/8" bumpers located on top of case
- Drop-through trash option is available with all top options except with full clear glass (FG GC00)

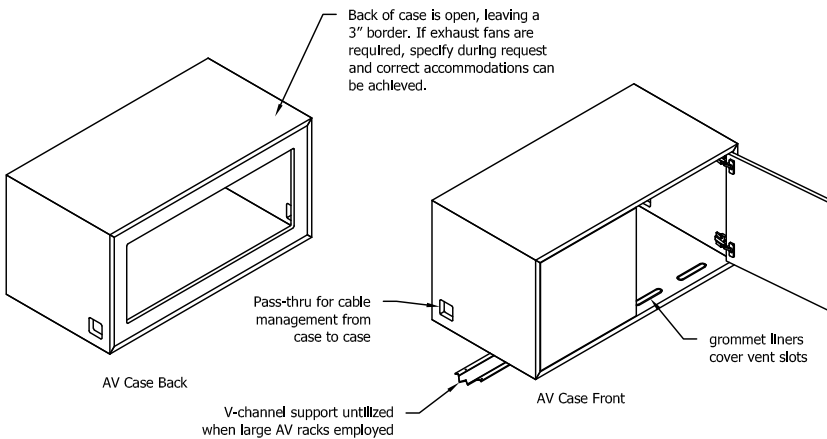

AV CASE

- All AV cases have an open back with a 3" border
- Coordinate AV requirements with the interior clearance dimensions provided below to ensure fit

18" Case

14.25" wide x 22.18" deep x 21.15" high

24" Case

20.25" wide x 22.18" deep x 21.15" high

47" Case

41.25" wide x 22.18" deep x 21.15" high

General Specifications

Highline 1 High Credenzas

1 High - Positional Configurations

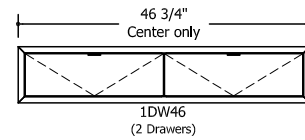
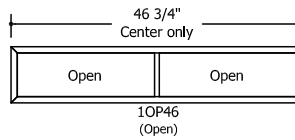
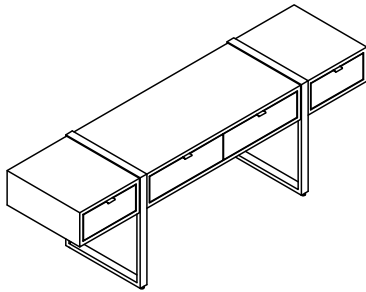
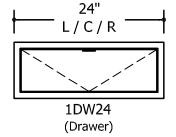
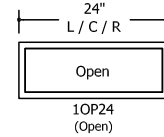
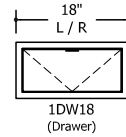
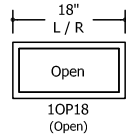
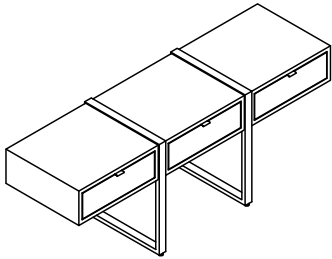

General Specifications

Highline 2 High Credenzas

2 High - Positional Configurations

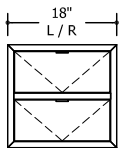
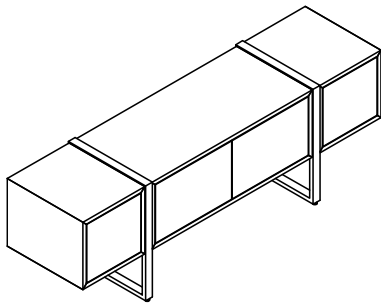

2DW18
(2 Drawers)

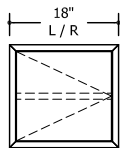

2DR18
(Door w/adj. Shelf)

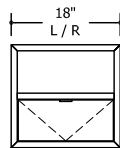

2OW18
(Open over Drawer)

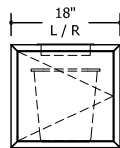

2TT18
(Trash thru Top
w/1 single can only)

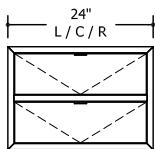

2DW24
(2 Drawers)

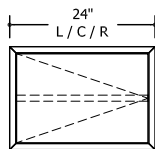

2DR24
(Door w/adj. Shelf)

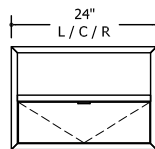

2OW24
(Open over Drawer)

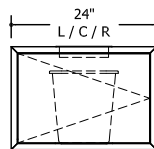

2TT24
(Trash thru Top
w/1 single can only)

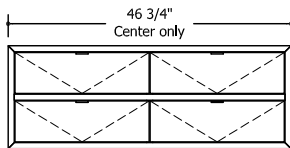

2DW46
(4 Drawers)

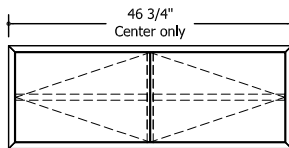

2DR46
(2 Doors w/2 adj. Shelves)

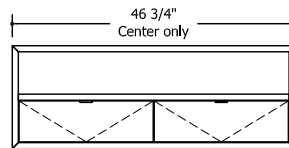

2OW46
(Open over 2 Drawers)

General Specifications

Highline 3 High Credenzas

3 High - Positional Configurations

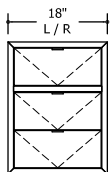
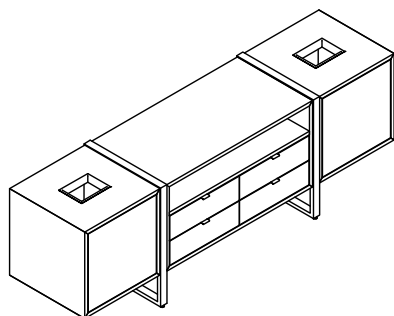

3DW18
(3 Drawers)

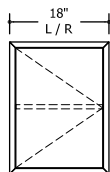

3DR18
(Door w/adj. shelf)

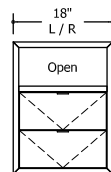

3OW18
(Open over 2 Drawers)

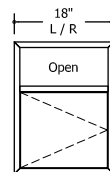

3OR18
(Open over Door)

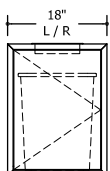

3TT18
(Trash thru top
w/1 single can only)

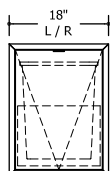

3TP18
(Trash pullout w/2
single cans front to back)

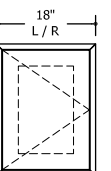

3AV18
(AV case, venting,
Large wire access)

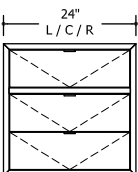

3DW24
(3 Drawers)

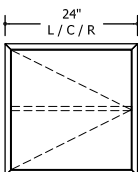

3DR24
(Door w/adj. shelf)

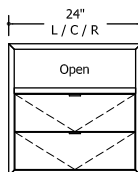

3OW24
(Open over 2 Drawers)

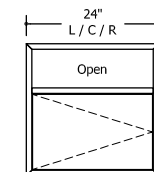

3OR24
(Open over Door)

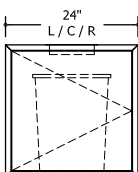

3TT24
(Trash thru top
w/1 single can only)

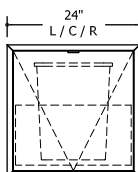

3TP24
(Trash pullout w/2
single cans front to back)

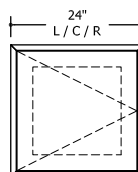

3AV24
(AV case, venting,
Large wire access)

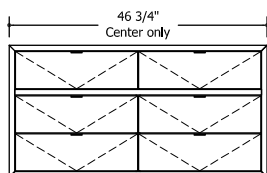

3DW46
(6 Drawers)

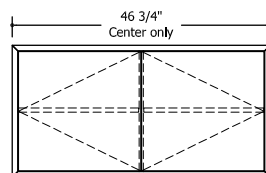

3DR46
(2 Doors w/2adj. shelf)

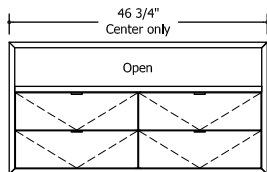

3OW46
(Open over 4 Drawers)

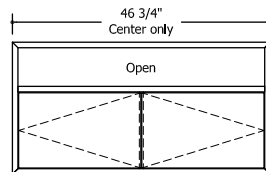

3OR46
(Open over Doors)

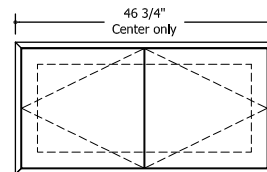

3AV46
(AV case, venting, Large wire access)

Highline Credenzas

Highline 1 High Credenzas

22" Deep, 29" High

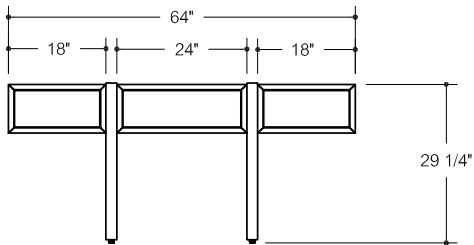

02C1H64

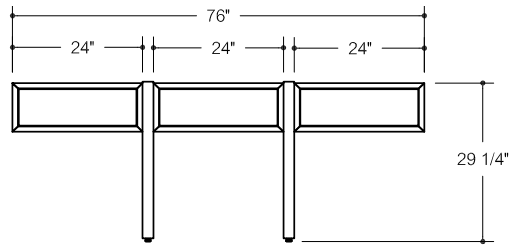

02C1H76

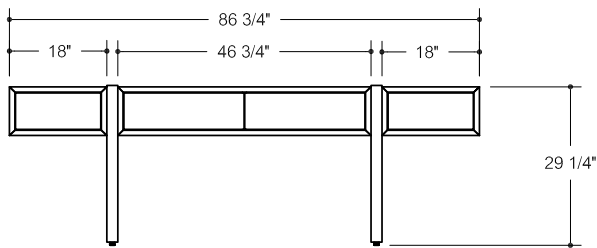

02C1H87

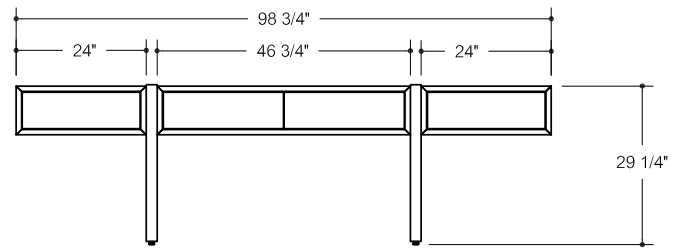

02C1H99

Highline Credenzas

Highline 1 High Credenzas

22" Deep, 29" High

Starting price in SL finish and MC base

Pattern No.	Starting Price	T1__ Shell	T2__ Shell	HG__ Shell	PM01/ PM02 Base	PM03 Base	T1__ Face	T2__ Face	HG__ Face
02C1H64	\$9,846	\$1,285	\$2,510	\$4,206	\$421	\$786	\$427	\$836	\$1,402
02C1H76	10,492	1,463	2,861	4,819	421	786	488	955	1,605
02C1H87	11,679	1,626	3,188	5,368	421	786	542	1,062	1,790
02C1H99	12,628	1,800	3,539	5,985	421	786	600	1,180	1,996

Top Upcharges

GC00 Full Top	GC__ Section Top	GC__ Center Top	GE__ Section Top	GE__ Center Top	CS01 Section Top	CS01 Center Top
\$1,092	\$1,321	\$513	\$1,816	\$741	\$2,250	\$917
1,299	1,539	513	2,221	741	2,753	917
1,480	1,990	1,183	2,624	1,548	3,441	2,108
1,688	2,209	1,183	3,028	1,548	3,943	2,108

Configuration Upcharges

L	Pattern No.	Description	Price
18"	02OP18H1	Open	\$-
24"	02OP24H1	Open	-
46"	02OP46H1	Open	-
18"	02DW18H1	Drawer	640
24"	02DW24H1	Drawer	638
46"	02DW46H1	Drawer	1,294

Highline Credenzas

Highline 2 High Credenzas

22" Deep, 29" High

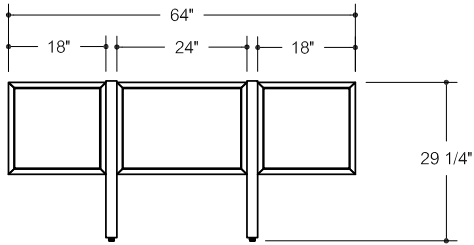

02C2H64

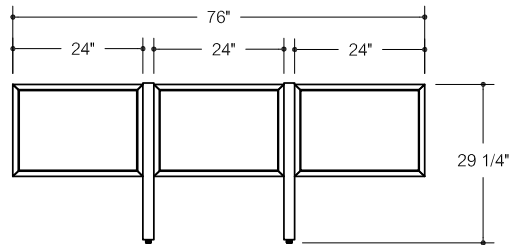

02C2H76

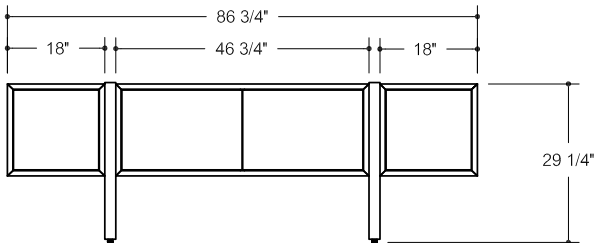

02C2H87

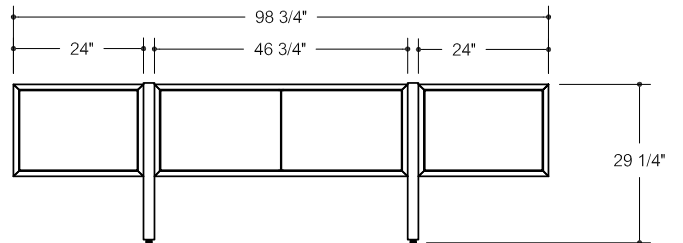

02C2H99

Highline Credenzas

Highline 2 High Credenzas

22" Deep, 29" High

Starting price in SL finish and MC base

Pattern No.	Starting Price	T1__ Shell	T2__ Shell	HG__ Shell	PM01/ PM02 Base	PM03 Base	T1__ Face	T2__ Face	HG__ Face
02C2H64	\$12,403	\$1,863	\$4,111	\$7,732	\$421	\$786	\$620	\$1,370	\$2,578
02C2H76	13,149	2,047	4,542	8,640	421	786	683	1,514	2,880
02C2H87	14,823	2,284	5,027	9,460	421	786	761	1,675	3,154
02C2H99	15,741	2,516	5,511	10,370	421	786	839	1,838	3,456

Top Upcharges

GC00 Full Top	GC__ Section Top	GC__ Center Top	GE__ Section Top	GE__ Center Top	CS01 Section Top	CS01 Center Top
\$1,092	\$1,321	\$513	\$1,816	\$741	\$2,250	\$917
1,299	1,539	513	2,221	741	2,753	917
1,480	1,990	1,183	2,624	1,548	3,441	2,108
1,688	2,209	1,183	3,028	1,548	3,943	2,108

Configuration Upcharges

L	Pattern No.	Description	Price
18"	02DW18H2	Drawers	\$489
24"	02DW24H2	Drawers	772
46"	02DW46H2	Drawers	1,204
18"	02DR18H2	Door	-
24"	02DR24H2	Door	-
46"	02DR46H2	Door	-
18"	02OW18H2	Open Over Drawer	386
24"	02OW24H2	Open Over Drawer	566
46"	02OW46H2	Open Over Drawer	788
18"	02TT18H2	Trash Thru Top	896
24"	02TT24H2	Trash Thru Top	889

Highline Credenzas

Highline 3 High Credenzas

24" Deep, 33" High

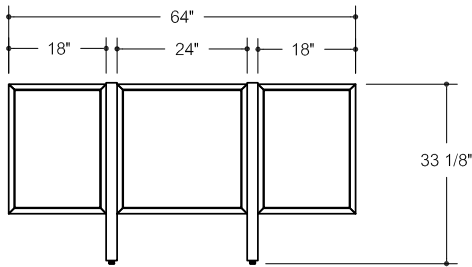

02C3H64

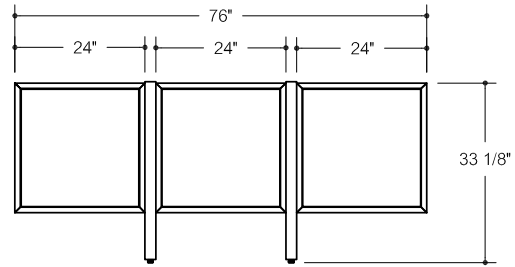

02C3H76

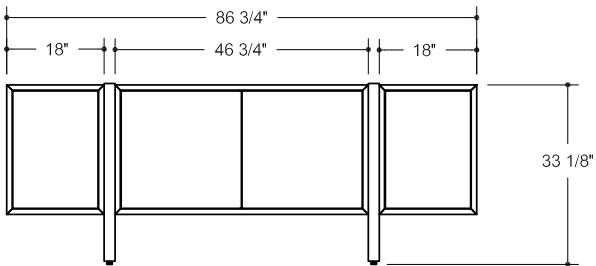

02C3H87

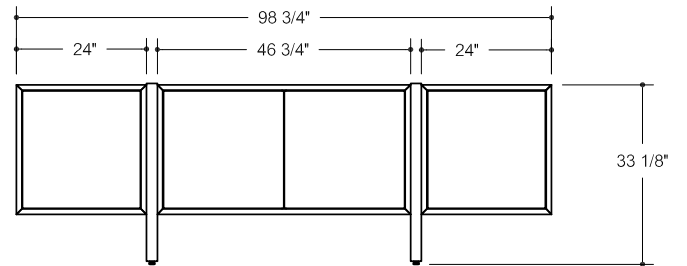

02C3H99

Highline Credenzas

Highline 3 High Credenzas

24" Deep, 33" High

Starting price in SL finish and MC base

L	Pattern No.	Starting Price	T1__ Shell	T2__ Shell	HG__ Shell	PM01/ PM02 Base	PM03 Base	T1__ Face	T2__ Face	HG__ Face
64"	02C3H64	\$13,606	\$2,319	\$5,368	\$10,532	\$421	\$786	\$772	\$1,790	\$3,512
76"	02C3H76	15,059	2,516	5,877	11,521	421	786	839	1,960	3,841
87"	02C3H87	16,139	2,866	6,509	12,667	421	786	956	2,169	4,222
99"	02C3H99	18,089	3,691	7,670	14,482	421	786	1,230	2,557	4,828

Top Upcharges

GC00 Full Top	GC__ Section Top	GC__ Center Top	GE__ Section Top	GE__ Center Top	CS01 Section Top	CS01 Center Top
\$1,092	\$1,321	\$513	\$1,816	\$741	\$2,250	\$917
1,299	1,539	513	2,221	741	2,753	917
1,480	1,990	1,183	2,624	1,548	3,441	2,108
1,688	2,209	1,183	3,028	1,548	3,943	2,108

Configuration Upcharges

L	Pattern No.	Description	Price
18"	02DW18H3	Drawers	\$1,048
24"	02DW24H3	Drawers	1,380
46"	02DW46H3	Drawers	1,722
18"	02DR18H3	Door	-
24"	02DR24H3	Door	-
46"	02DR46H3	Door	-
18"	02OW18H3	Open Over Drawer	833
24"	02OW24H3	Open Over Drawer	752
46"	02OW46H3	Open Over Drawer	1,331
18"	02OR18H3	Open Over Door	713
24"	02OR24H3	Open Over Door	719
46"	02OR46H3	Open Over Door	401
18"	02TT18H3	Trash Thru Top	901
24"	02TT24H3	Trash Thru Top	885

18"	02TP18H3	Trash Pull-Out	1,566
24"	02TP24H3	Trash Pull-Out	1,547
18"	02AV18H3	AV Case	499
24"	02AV24H3	AV Case	486
46"	02AV46H3	AV Case	525

Highline Fifty Collection

Highline Fifty Conference Tables



DATESWEISER

General Specifications

Highline Fifty Conference Tables

Overall Elevations and Clearance

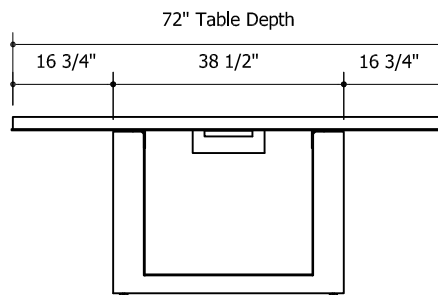
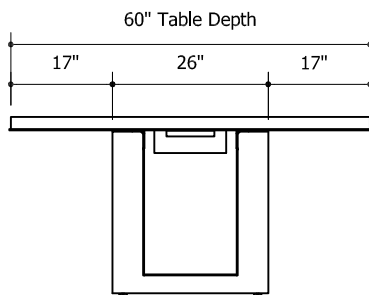
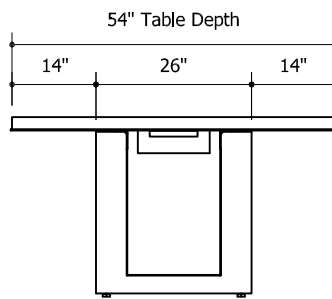
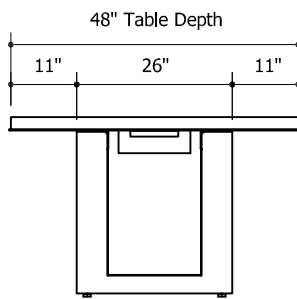
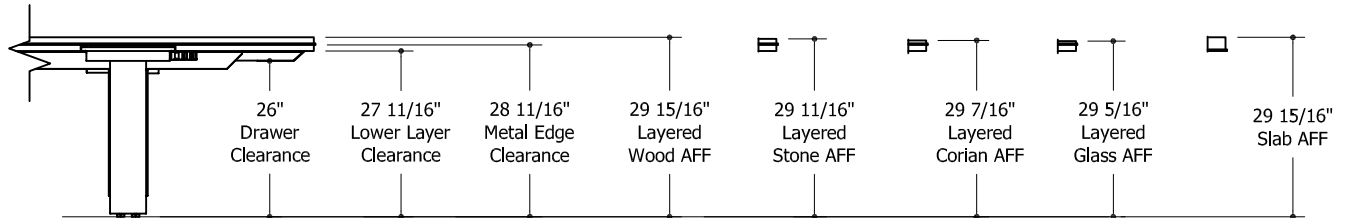

General Specifications

Highline Fifty Conference Tables

Top Construction

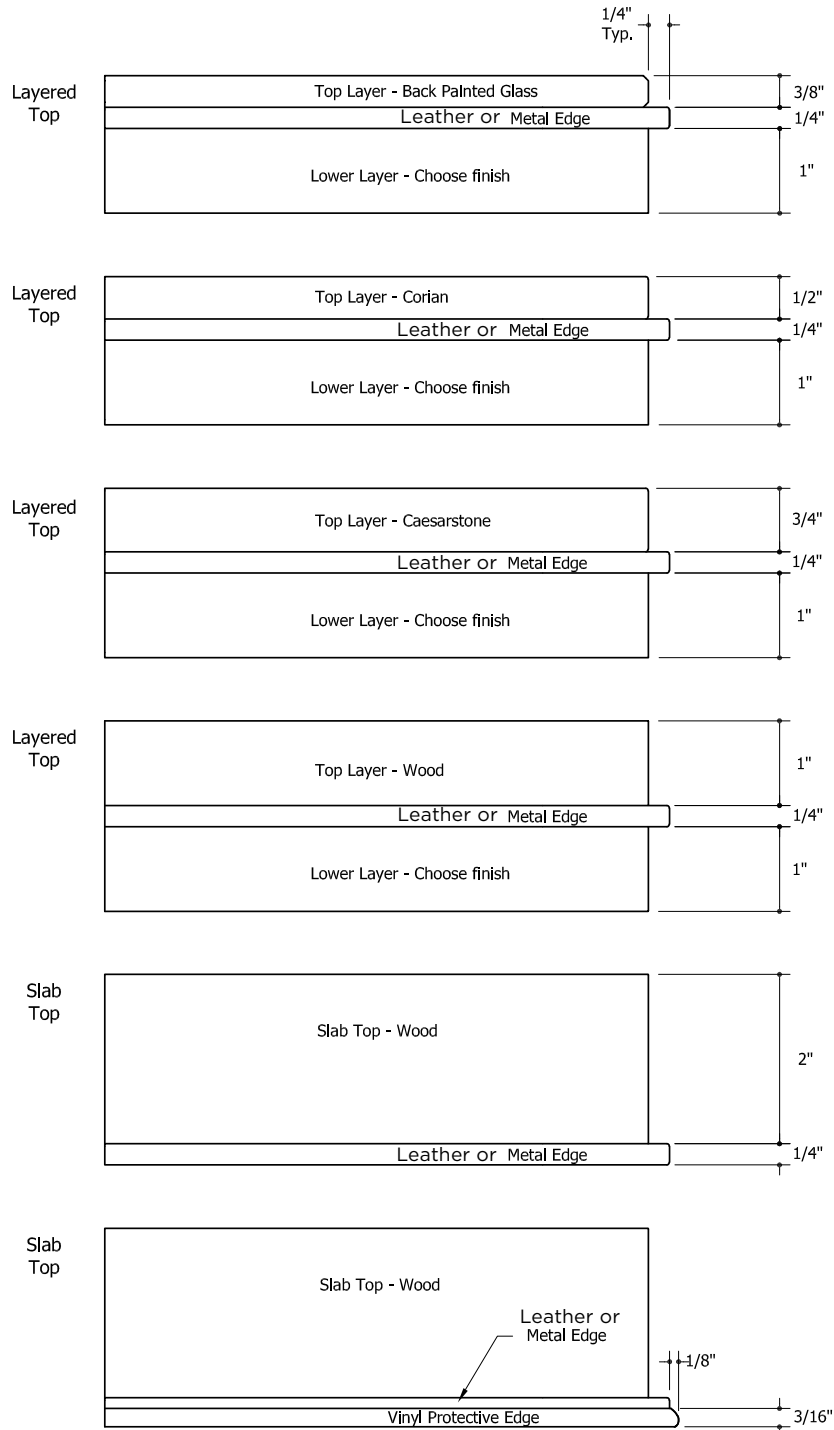

General Specifications

Highline Fifty Conference Tables

Base Construction / Wire Management

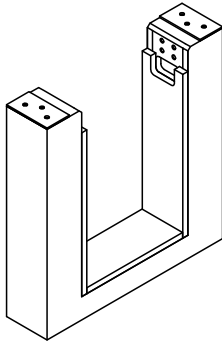

Small base : 42" / 48" / 54" / 60" Deep Tables
"ON" Open Base, no metal trim

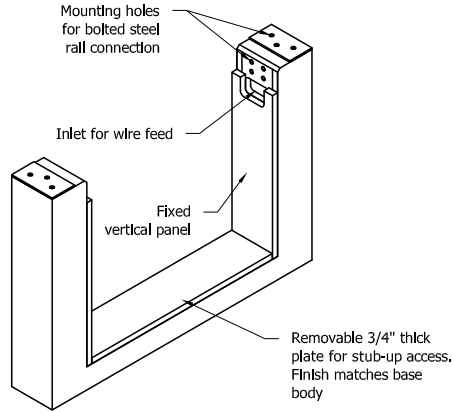

Large base : 72" Deep Tables
"ON" Open Base, no metal trim

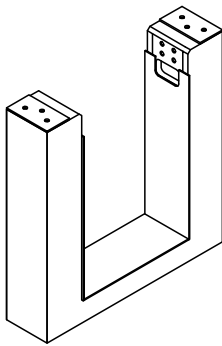

Small base : 42" / 48" / 54" / 60" Deep Tables
"OT" Open Base, with metal trim

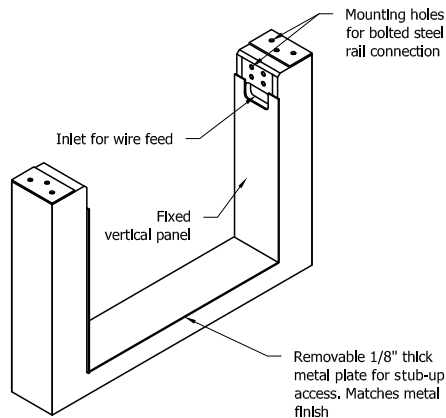

Large base : 72" Deep Tables
"OT" Open Base, with metal trim

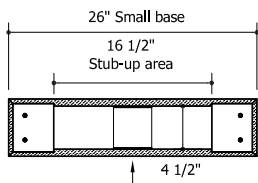

Horizontal section of Small Base

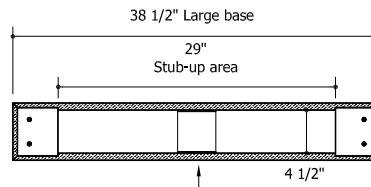

Horizontal section of Large base

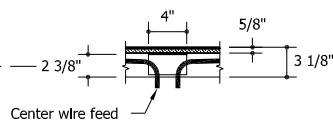

Vertical section at center of Base

General Specifications

Highline Fifty Conference Tables

Power Drawer / Connectivity Layout

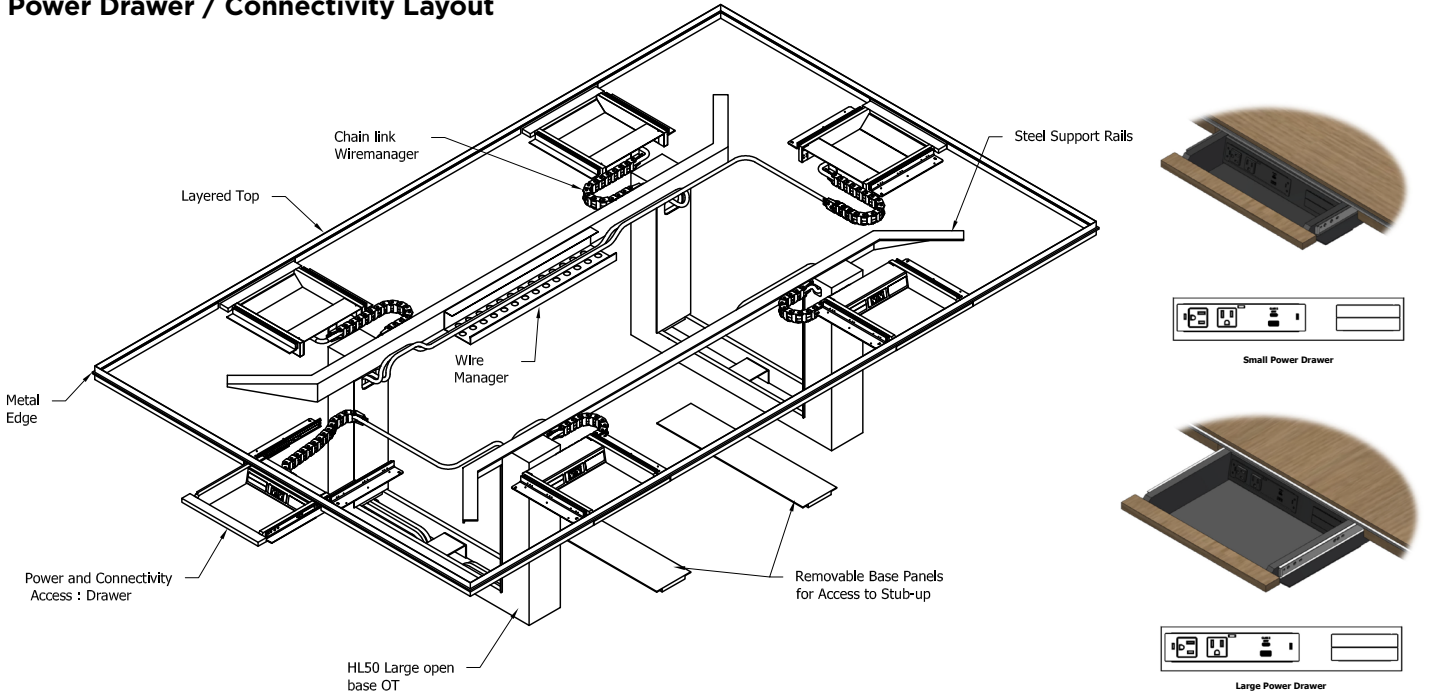
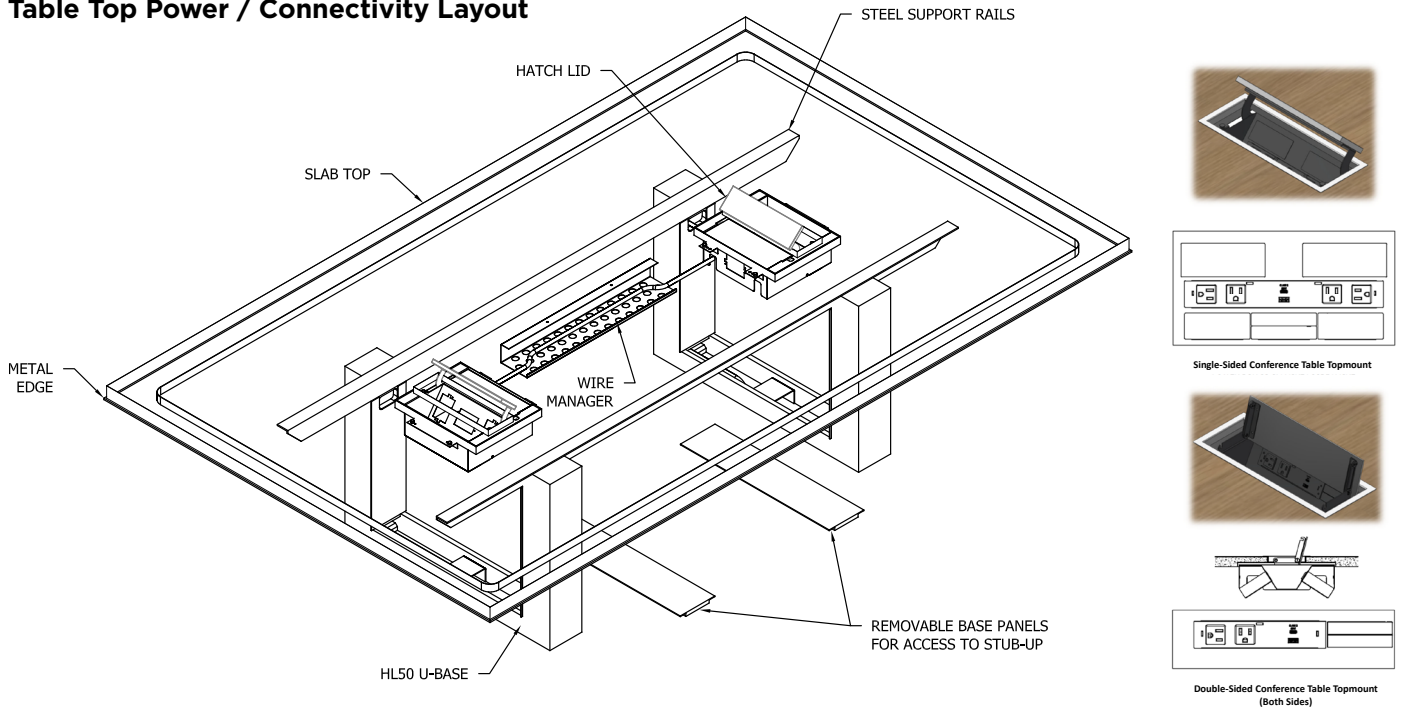

Table Top Power / Connectivity Layout



General Specifications

Highline Fifty Conference Tables

Undermount Power / Connectivity Layout

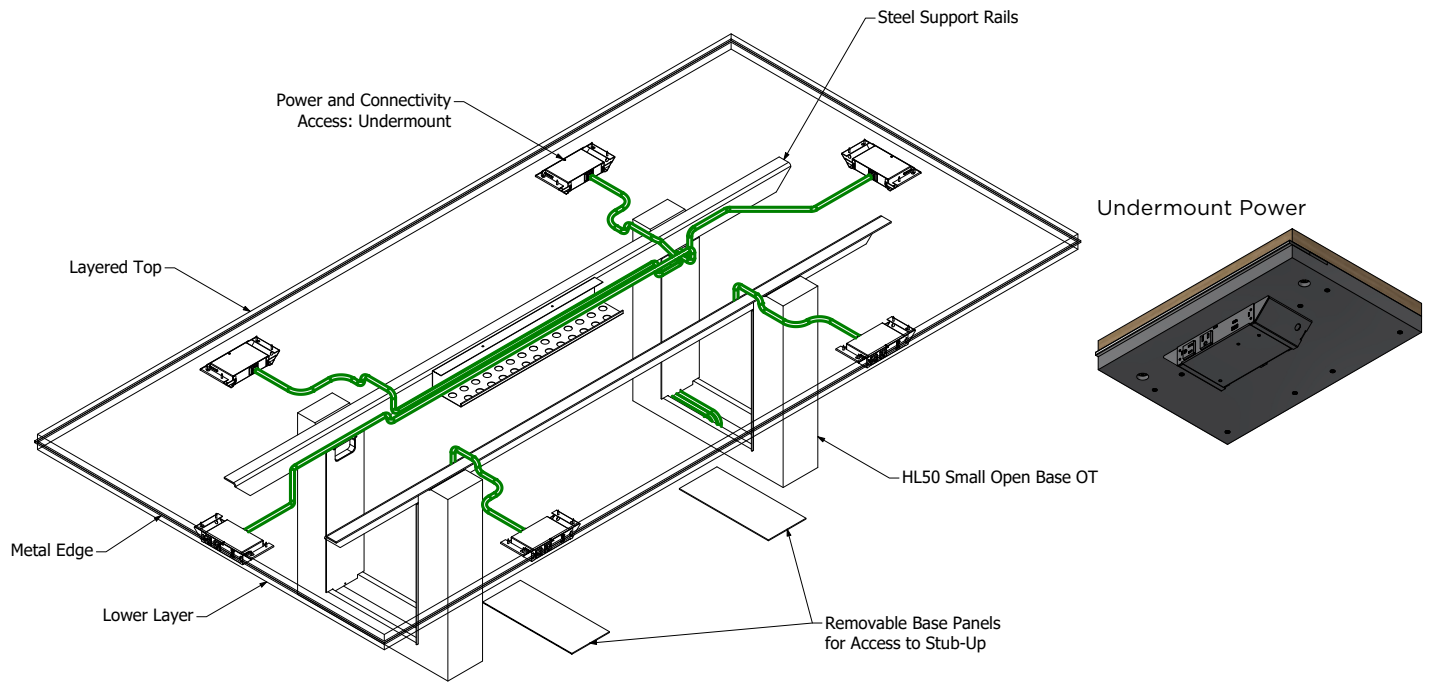

General Specifications

Highline Fifty Conference Tables

Undermount Power / Connectivity Layout

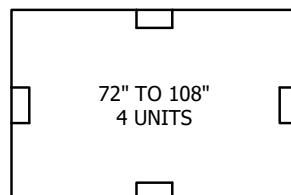
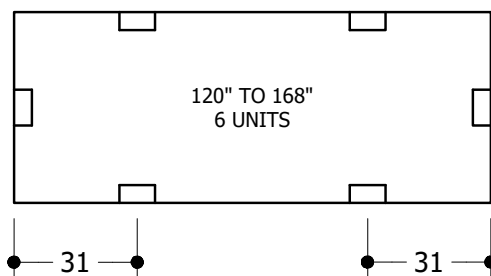
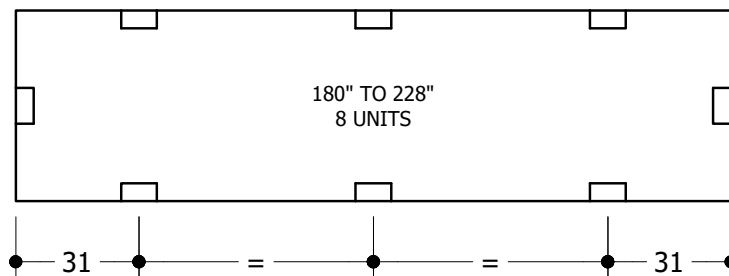
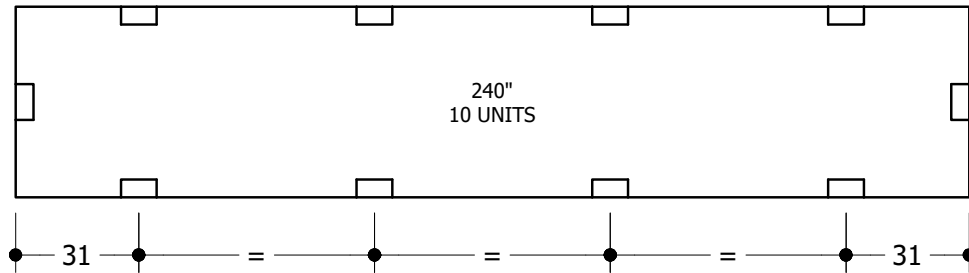

POWER LOCATIONS & QUANTITY BY TABLE LENGTH

Rectangular Conference Tables

48" Deep Tops

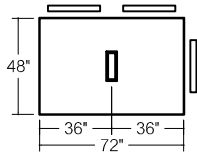
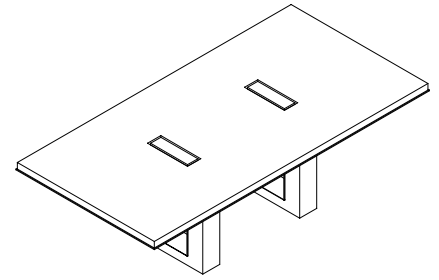

03R48X72
6 Person Table

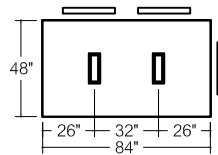

03R48X84
6 Person Table

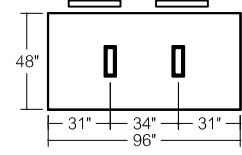

03R48X96
6 Person Table

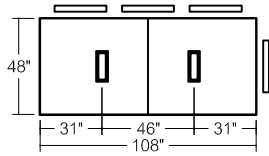

03R48X108
8 Person Table

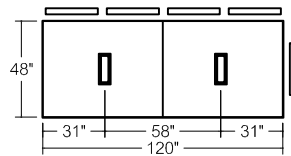

03R48X120
10 Person Table

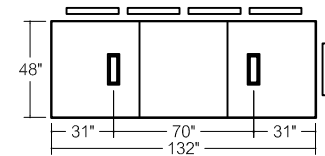

03R48X132
10 Person Table

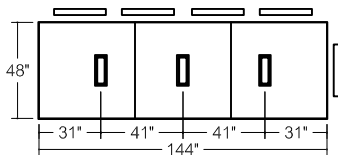

03R48X144
10 Person Table

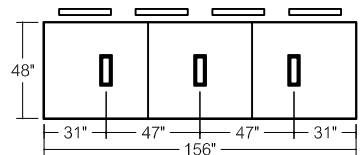

03R48X156
10 Person Table

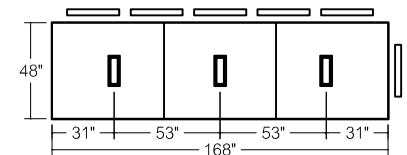

03R48X168
12 Person Table

Rectangular Conference Tables

48" Deep Tops

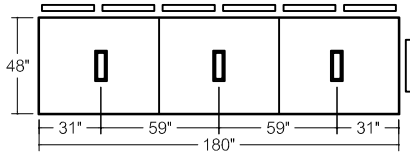
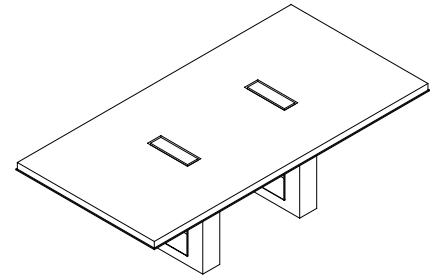

03R48X180
14 Person Table

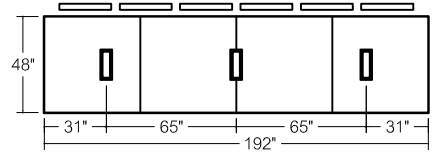

03R48X192
14 Person Table

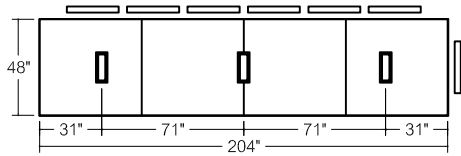

03R48X204
14 Person Table

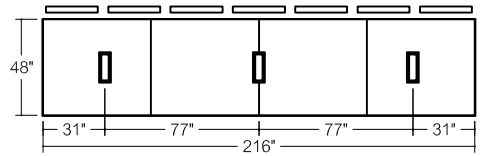

03R48X216
16 Person Table

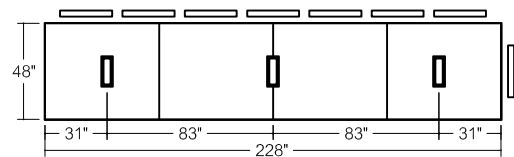

03R48X228
16 Person Table

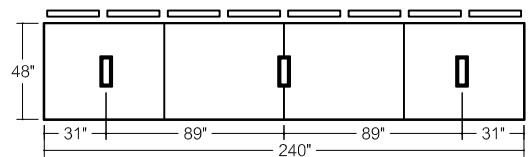

03R48X240
18 Person Table

Rectangular Conference Tables

48" Deep Tops
Veneer Top

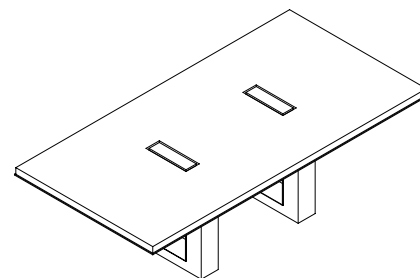

D	W	Pattern No.	T1__ Top	T2__ Top	PM01/ PM02 Edge Upcharge	PM03 Edge Upcharge	AU__ Edge Upcharge	SL__ Lower Layer	T__ Lower Layer	HG__ Lower Layer
48"	72"	03R48X72	\$15,669	\$16,334	\$849	\$849	\$2,069	\$333	\$531	\$583
48"	84"	03R48X84	16,821	17,596	1,323	1,323	2,278	399	604	665
48"	96"	03R48X96	17,692	18,577	1,323	1,323	2,484	417	628	694
48"	108"	03R48X108	19,231	20,226	1,323	1,323	2,691	457	696	767
48"	120"	03R48X120	20,318	21,426	1,379	1,379	2,898	598	795	874
48"	132"	03R48X132	25,386	26,604	1,380	1,380	3,105	604	850	935
48"	144"	03R48X144	26,652	27,980	1,379	1,379	3,313	618	903	991
48"	156"	03R48X156	27,480	28,919	1,379	1,379	3,520	637	909	1,001
48"	168"	03R48X168	28,955	30,505	2,269	2,269	3,727	696	1,002	1,103
48"	180"	03R48X180	29,863	31,199	2,269	2,269	3,933	737	1,107	1,219
48"	192"	03R48X192	34,518	36,290	2,269	2,269	4,141	802	1,133	1,247
48"	204"	03R48X204	35,460	37,343	2,269	2,269	4,348	842	1,194	1,313
48"	216"	03R48X216	36,394	38,387	2,269	2,269	4,554	884	1,261	1,388
48"	228"	03R48X228	37,360	39,465	2,269	2,269	4,762	895	1,326	1,460
48"	240"	03R48X240	38,278	40,492	2,269	2,269	4,968	942	1,426	1,568

Base and Base Trim Upcharges

# of bases	T1__ Base	T2__ Base	HG__ Base	OT (for MC Base Metal)	PM01/PM02 Base Metal	PM03 Base Metal
2 base	\$904	\$1,894	\$4,136	\$3,589	\$4,828	\$6,033
3 base	1,356	2,841	6,204	5,381	7,242	9,051

Order Code	Specification Information	Refer To Accessories Section	Pricing Tiers
Example: 03R48X72-T003-PM01-MC01-SL01-SL01-UCO	To order please specify pattern number including:	Please refer to Accessories section, page 211 for power details.	Please refer to Materials and Finish page 7 for specification details.
03 Highline 50 Collection	1. Top finish	Grommet options available in these finishes:	T1 and T2 pricing includes powder coated base finish.
R Rectangular	2. Base Option	Powder coated	There is an upcharge for plated base finishes as highlighted above.
48 Depth	3. Edge Opt./Finish (only applies if trim type is metal or leather)	Premium (Polished Chrome, Satin Nickel or Oil Rubbed Bronze)	For additional stone options and pricing please contact your sales representative."
72 Width	4. Lower Layer Finish	Power Box Options	
T003 Top Finish	5. Base Finish	Code: Description:	
PM01 Base Option	6. Power box option	NP No Power	
MC01 Edge Option/Finish	7. Table-top power finish (only applies if table-top power is selected)	UCO Undermount	
SL01 Lower Layer Finish	Trim Type	ECO Table Top Lid	
SL01 Base Finish	N = No trim	T1E Tabletop 1-Sided Lid	
UCO Undermount	M = Metal (available in Premium and Powder Coat finishes)	T2C Tabletop 2-Sided Lid	
	L = Leather	Must select Wire Management	
		Column and Finish:	
		Powder coated	
		Premium (Polished Chrome, Satin Nickel or Oil Rubbed Bronze)	

Rectangular Conference Tables

48" Deep Tops
Glass Top

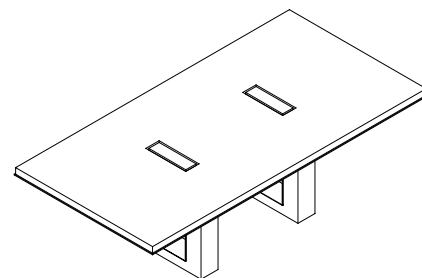

D	W	Pattern No.	GC__ Top	GE__ Top	PM01/ PM02 Edge Upcharge	PM03 Edge Upcharge	AU__ Edge Upcharge	SL__ Lower Layer	T__ Lower Layer	HG__ Lower Layer
48"	72"	03R48X72	\$19,311	\$19,913	\$849	\$849	\$2,069	\$333	\$531	\$583
48"	84"	03R48X84	21,007	21,711	1,323	1,323	2,278	399	604	665
48"	96"	03R48X96	22,413	23,217	1,323	1,323	2,484	417	628	694
48"	108"	03R48X108	24,514	25,417	1,323	1,323	2,691	457	696	767
48"	120"	03R48X120	26,144	27,147	1,379	1,379	2,898	598	795	874
48"	132"	03R48X132	31,922	33,026	1,380	1,380	3,105	604	850	935
48"	144"	03R48X144	33,739	34,943	1,379	1,379	3,313	618	903	991
48"	156"	03R48X156	35,098	36,404	1,379	1,379	3,520	637	909	1,001
48"	168"	03R48X168	37,133	38,538	2,269	2,269	3,727	696	1,002	1,103
48"	180"	03R48X180	38,577	40,082	2,269	2,269	3,933	737	1,107	1,219
48"	192"	03R48X192	43,924	45,531	2,269	2,269	4,141	802	1,133	1,247
48"	204"	03R48X204	45,403	47,110	2,269	2,269	4,348	842	1,194	1,313
48"	216"	03R48X216	46,872	48,677	2,269	2,269	4,554	884	1,261	1,388
48"	228"	03R48X228	48,376	50,282	2,269	2,269	4,762	895	1,326	1,460
48"	240"	03R48X240	49,830	51,837	2,269	2,269	4,968	942	1,426	1,568

Base and Base Trim Upcharges

# of bases	T1__ Base	T2__ Base	HG__ Base	OT (for MC Base Metal)	PM01/PM02 Base Metal	PM03 Base Metal
2 base	\$904	\$1,894	\$4,136	\$3,589	\$4,828	\$6,033
3 base	1,356	2,841	6,204	5,381	7,242	9,051

Order Code	Specification Information	Refer To Accessories Section	Pricing Tiers
Example: 03R48X72-GE01-PM01-MC01-SL01-SL01-UCO	To order please specify pattern number including:	Please refer to Accessories section, page 211 for power details.	Please refer to Materials and Finish page 7 for specification details.
03 Highline 50 Collection	1. Top finish	Grommet options available in these finishes:	T1 and T2 pricing includes powder coated base finish.
R Rectangular	2. Base Option	Powder coated	There is an upcharge for plated base finishes as highlighted above.
48 Depth	3. Edge Opt./Finish (only applies if trim type is metal or leather)	Premium (Polished Chrome, Satin Nickel or Oil Rubbed Bronze)	For additional stone options and pricing please contact your sales representative."
72 Width	4. Lower Layer Finish	Power Box Options	
GE01 Top Finish	5. Base Finish	Code: Description:	
PM01 Base Option	6. Power box option	NP No Power	
MC01 Edge Option/Finish	7. Table-top power finish (only applies if table-top power is selected)	UCO Undermount	
SL01 Lower Layer Finish	Trim Type	ECO Table Top Lid	
SL01 Base Finish	N = No trim	T1E Tabletop 1-Sided Lid	
UCO Undermount	M = Metal (available in Premium and Powder Coat finishes)	T2C Tabletop 2-Sided Lid	
	L = Leather	Must select Wire Management Column and Finish:	
		Powder coated	
		Premium (Polished Chrome, Satin Nickel or Oil Rubbed Bronze)	

Rectangular Conference Tables

48" Deep Tops
Corian Top

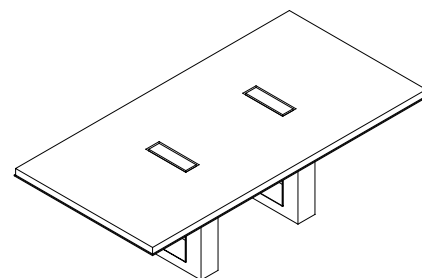

D	W	Pattern No.	CS01 Top	PM01/ PM02 Edge Upcharge	PM03 Edge Upcharge	AU__ Edge Upcharge	SL__ Lower Layer	T__ Lower Layer	HG__ Lower Layer
48"	72"	03R48X72	\$19,856	\$849	\$849	\$2,069	\$333	\$531	\$583
48"	84"	03R48X84	21,707	1,323	1,323	2,278	399	604	665
48"	96"	03R48X96	23,276	1,323	1,323	2,484	417	628	694
48"	108"	03R48X108	25,513	1,323	1,323	2,691	457	696	767
48"	120"	03R48X120	27,298	1,379	1,379	2,898	598	795	874
48"	132"	03R48X132	33,064	1,380	1,380	3,105	604	850	935
48"	144"	03R48X144	35,028	1,379	1,379	3,313	618	903	991
48"	156"	03R48X156	36,556	1,379	1,379	3,520	637	909	1,001
48"	168"	03R48X168	38,728	2,269	2,269	3,727	696	1,002	1,103
48"	180"	03R48X180	40,334	2,269	2,269	3,933	737	1,107	1,219
48"	192"	03R48X192	45,686	2,269	2,269	4,141	802	1,133	1,247
48"	204"	03R48X204	47,327	2,269	2,269	4,348	842	1,194	1,313
48"	216"	03R48X216	48,958	2,269	2,269	4,554	884	1,261	1,388
48"	228"	03R48X228	50,622	2,269	2,269	4,762	895	1,326	1,460
48"	240"	03R48X240	52,239	2,269	2,269	4,968	942	1,426	1,568

Base and Base Trim Upcharges

# of bases	T1__ Base	T2__ Base	HG__ Base	OT (for MC Base Metal)	PM01/PM02 Base Metal	PM03 Base Metal
2 base	\$904	\$1,894	\$4,136	\$3,589	\$4,828	\$6,033
3 base	1,356	2,841	6,204	5,381	7,242	9,051

Order Code	Specification Information	Refer To Accessories Section	Pricing Tiers
Example: 03R48X72-CS01-PM01-MC01-SL01-SL01-UCO	To order please specify pattern number including:	Please refer to Accessories section, page 211 for power details.	Please refer to Materials and Finish page 7 for specification details.
03 Highline 50 Collection	1. Top finish	Grommet options available in these finishes:	T1 and T2 pricing includes powder coated base finish.
R Rectangular	2. Base Option	Powder coated	There is an upcharge for plated base finishes as highlighted above.
48 Depth	3. Edge Opt./Finish (only applies if trim type is metal or leather)	Premium (Polished Chrome, Satin Nickel or Oil Rubbed Bronze)	For additional stone options and pricing please contact your sales representative."
72 Width	4. Lower Layer Finish	Power Box Options	
CS01 Top Finish	5. Base Finish	Code: Description:	
PM01 Base Option	6. Power box option	NP No Power	
MC01 Edge Option/Finish	7. Table-top power finish (only applies if table-top power is selected)	UCO Undermount	
SL01 Lower Layer Finish	Trim Type	ECO Table Top Lid	
SL01 Base Finish	N = No trim	T1E Tabletop 1-Sided Lid	
UCO Undermount	M = Metal (available in Premium and Powder Coat finishes)	T2C Tabletop 2-Sided Lid	
	L = Leather	Must select Wire Management Column and Finish:	
		Powder coated	
		Premium (Polished Chrome, Satin Nickel or Oil Rubbed Bronze)	

Rectangular Conference Tables

54" Deep Tops

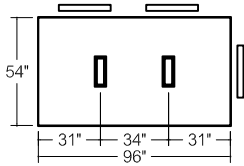
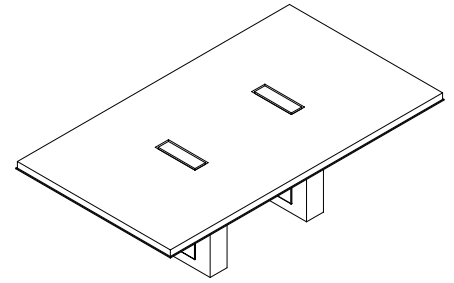

03R54X96

6 Person Table

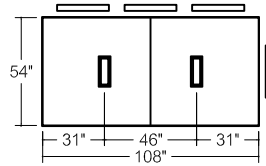

03R54X108

8 Person Table

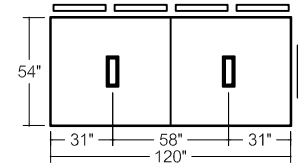

03R54X120

10 Person Table

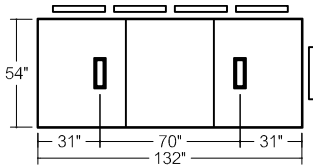

03R54X132

10 Person Table

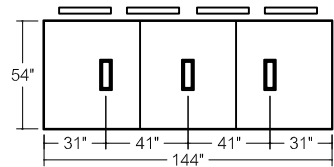

03R54X144

10 Person Table

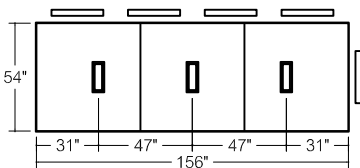

03R54X156

10 Person Table

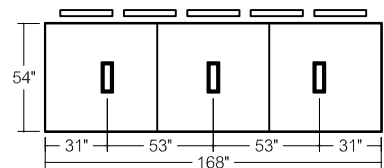

03R54X168

12 Person Table

Rectangular Conference Tables

54" Deep Tops

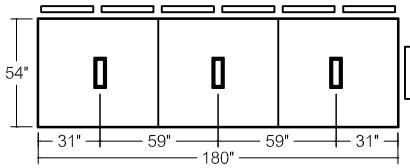
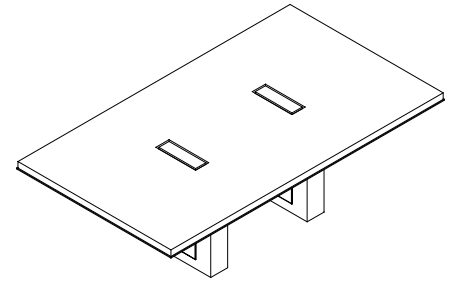

03R54X180
14 Person Table

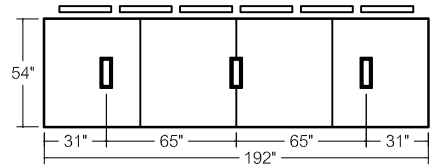

03R54X192
14 Person Table

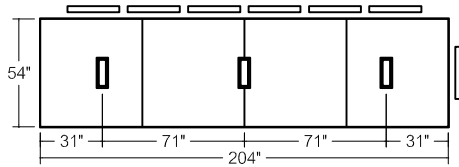

03R54X204
14 Person Table

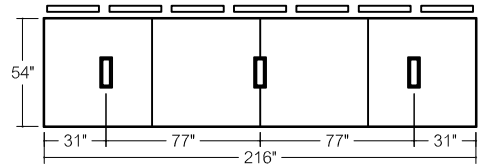

03R54X216
16 Person Table

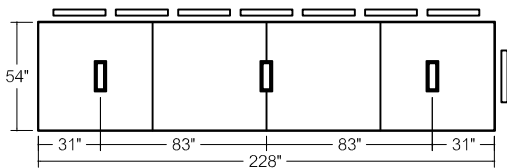

03R54X228
16 Person Table

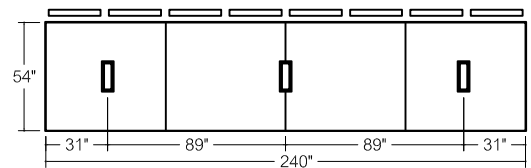

03R54X240
18 Person Table

Rectangular Conference Tables

54" Deep Tops
Veneer Top

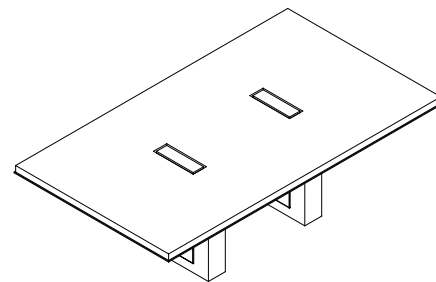

D	W	Pattern No.	T1__ Top	T2__ Top	PM01/ PM02 Edge Upcharge	PM03 Edge Upcharge	AU__ Edge Upcharge	SL__ Lower Layer	T__ Lower Layer	HG__ Lower Layer
54"	96"	03R54X96	\$19,954	\$20,950	\$849	\$849	\$2,069	\$333	\$531	\$583
54"	108"	03R54X108	21,688	22,810	1,323	1,323	2,278	399	604	665
54"	120"	03R54X120	22,831	24,076	1,323	1,323	2,484	417	628	694
54"	132"	03R54X132	28,614	29,984	1,323	1,323	2,691	457	696	767
54"	144"	03R54X144	30,039	31,534	1,379	1,379	2,898	598	795	874
54"	156"	03R54X156	30,988	32,607	1,380	1,380	3,105	604	850	935
54"	168"	03R54X168	32,648	34,393	1,379	1,379	3,313	618	903	991
54"	180"	03R54X180	33,683	35,540	1,379	1,379	3,520	637	909	1,001
54"	192"	03R54X192	38,912	40,905	2,269	2,269	3,727	696	1,002	1,103
54"	204"	03R54X204	39,974	42,092	2,269	2,269	3,933	737	1,107	1,219
54"	216"	03R54X216	41,022	43,263	2,269	2,269	4,141	802	1,133	1,247
54"	228"	03R54X228	42,112	44,477	2,269	2,269	4,348	842	1,194	1,313
54"	240"	03R54X240	43,146	45,637	2,269	2,269	4,554	884	1,261	1,388

Base and Base Trim Upcharges

# of bases	T1__ Base	T2__ Base	HG__ Base	OT (for MC Base Metal)	PM01/PM02 Base Metal	PM03 Base Metal
2 base	\$904	\$1,894	\$4,136	\$3,589	\$4,828	\$6,033
3 base	1,356	2,841	6,204	5,381	7,242	9,051

Order Code	Specification Information	Refer To Accessories Section	Pricing Tiers
Example: 03R54X96-T003-PM01-MC01-SL01-SL01-UCO	To order please specify pattern number including:	Please refer to Accessories section, page 211 for power details.	Please refer to Materials and Finish page 7 for specification details.
03 Highline 50 Collection	1. Top finish	Grommet options available in these finishes:	T1 and T2 pricing includes powder coated base finish.
R Rectangular	2. Base Option	Powder coated	There is an upcharge for plated base finishes as highlighted above.
54 Depth	3. Edge Opt./Finish (only applies if trim type is metal or leather)	Premium (Polished Chrome, Satin Nickel or Oil Rubbed Bronze)	For additional stone options and pricing please contact your sales representative."
96 Width	4. Lower Layer Finish	Power Box Options	
T003 Top Finish	5. Base Finish	Code: Description:	
PM01 Base Option	6. Power box option	NP No Power	
MC01 Edge Option/Finish	7. Table-top power finish (only applies if table-top power is selected)	UCO Undermount	
SL01 Lower Layer Finish	Trim Type	ECO Table Top Lid	
SL01 Base Finish	N = No trim	T1E Tabletop 1-Sided Lid	
UCO Undermount	M = Metal (available in Premium and Powder Coat finishes)	T2C Tabletop 2-Sided Lid	
	L = Leather	Must select Wire Management	
		Column and Finish:	
		Powder coated	
		Premium (Polished Chrome, Satin Nickel or Oil Rubbed Bronze)	

Rectangular Conference Tables

**54" Deep Tops
Glass Top**

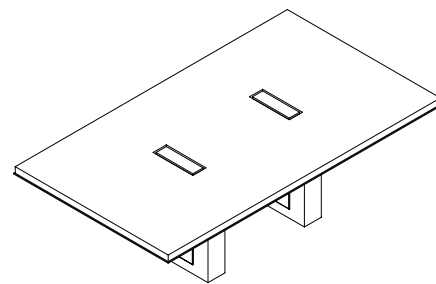

D	W	Pattern No.	GC__ Top	GE__ Top	PM01/ PM02 Edge Upcharge	PM03 Edge Upcharge	AU__ Edge Upcharge	SL__ Lower Layer	T__ Lower Layer	HG__ Lower Layer
54"	96"	03R54X96	\$25,268	\$26,170	\$849	\$849	\$2,069	\$333	\$531	\$583
54"	108"	03R54X108	27,636	28,651	1,323	1,323	2,278	399	604	665
54"	120"	03R54X120	29,384	30,512	1,323	1,323	2,484	417	628	694
54"	132"	03R54X132	35,969	37,211	1,323	1,323	2,691	457	696	767
54"	144"	03R54X144	38,013	38,013	1,379	1,379	2,898	598	795	874
54"	156"	03R54X156	39,562	41,029	1,380	1,380	3,105	604	850	935
54"	168"	03R54X168	41,852	43,432	1,379	1,379	3,313	618	903	991
54"	180"	03R54X180	43,476	45,171	1,379	1,379	3,520	637	909	1,001
54"	192"	03R54X192	49,498	51,303	2,269	2,269	3,727	696	1,002	1,103
54"	204"	03R54X204	51,162	53,083	2,269	2,269	3,933	737	1,107	1,219
54"	216"	03R54X216	52,813	54,847	2,269	2,269	4,141	802	1,133	1,247
54"	228"	03R54X228	54,508	56,653	2,269	2,269	4,348	842	1,194	1,313
54"	240"	03R54X240	56,145	58,403	2,269	2,269	4,554	884	1,261	1,388

Base and Base Trim Upcharges

# of bases	T1__ Base	T2__ Base	HG__ Base	OT (for MC Base Metal)	PM01/PM02 Base Metal	PM03 Base Metal
2 base	\$904	\$1,894	\$4,136	\$3,589	\$4,828	\$6,033
3 base	1,356	2,841	6,204	5,381	7,242	9,051

Order Code	Specification Information	Refer To Accessories Section	Pricing Tiers
Example: 03R54X96-GE01-PM01-MC01-SL01-SL01-UCO	To order please specify pattern number including:	Please refer to Accessories section, page 211 for power details.	Please refer to Materials and Finish page 7 for specification details.
03 Highline 50 Collection	1. Top finish	Grommet options available in these finishes:	T1 and T2 pricing includes powder coated base finish.
R Rectangular	2. Base Option	Powder coated	There is an upcharge for plated base finishes as highlighted above.
54 Depth	3. Edge Opt./Finish (only applies if trim type is metal or leather)	Premum (Polished Chrome, Satin Nickel or Oil Rubbed Bronze)	For additional stone options and pricing please contact your sales representative."
96 Width	4. Lower Layer Finish	Power Box Options	
GE01 Top Finish	5. Base Finish	Code: Description:	
PM01 Base Option	6. Power box option	NP No Power	
MC01 Edge Option/Finish	7. Table-top power finish (only applies if table-top power is selected)	UCO Undermount	
SL01 Lower Layer Finish	Trim Type	ECO Table Top Lid	
SL01 Base Finish	N = No trim	T1E Tabletop 1-Sided Lid	
UCO Undermount	M = Metal (available in Premium and Powder Coat finishes)	T2C Tabletop 2-Sided Lid	
	L = Leather	Must select Wire Management Column and Finish:	
		Powder coated	
		Premum (Polished Chrome, Satin Nickel or Oil Rubbed Bronze)	

Rectangular Conference Tables

54" Deep Tops
Corian Top

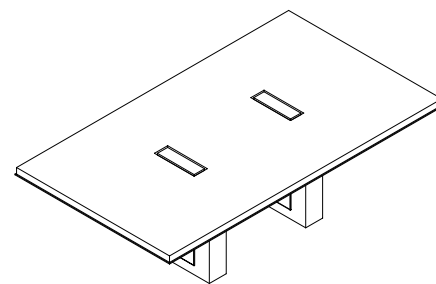

D	W	Pattern No.	CS01 Top	PM01/ PM02 Edge Upcharge	PM03 Edge Upcharge	AU__ Edge Upcharge	SL__ Lower Layer	T__ Lower Layer	HG__ Lower Layer
54"	96"	03R54X96	\$26,237	\$1,353	\$1,353	\$2,588	\$470	\$707	\$779
54"	108"	03R54X108	28,756	1,353	1,353	2,794	514	784	863
54"	120"	03R54X120	30,684	1,353	1,353	3,002	670	895	986
54"	132"	03R54X132	37,252	1,542	1,542	3,208	679	955	1,051
54"	144"	03R54X144	39,461	1,542	1,542	3,415	694	1,015	1,116
54"	156"	03R54X156	41,630	1,542	1,542	3,623	716	1,024	1,124
54"	168"	03R54X168	43,643	2,300	2,300	3,829	783	1,125	1,238
54"	180"	03R54X180	45,451	2,300	2,300	4,036	804	1,245	1,370
54"	192"	03R54X192	51,479	2,300	2,300	4,244	861	1,276	1,403
54"	204"	03R54X204	53,324	2,300	2,300	4,451	946	1,345	1,477
54"	216"	03R54X216	55,157	2,300	2,300	4,658	991	1,418	1,560
54"	228"	03R54X228	57,031	2,300	2,300	4,865	1,007	1,492	1,643
54"	240"	03R54X240	58,851	2,300	2,300	5,072	1,060	1,605	1,764

Base and Base Trim Upcharges

# of bases	T1__ Base	T2__ Base	HG__ Base	OT (for MC Base Metal)	PM01/PM02 Base Metal	PM03 Base Metal
2 base	\$904	\$1,894	\$4,136	\$3,589	\$4,828	\$6,033
3 base	1,356	2,841	6,204	5,381	7,242	9,051

Order Code	Specification Information	Refer To Accessories Section	Pricing Tiers
Example: 03R54X96-CS01-PM01-MC01-SL01-SLO1-UCO	To order please specify pattern number including:	Please refer to Accessories section, page 211 for power details.	Please refer to Materials and Finish page 7 for specification details.
03 Highline 50 Collection	1. Top finish	Grommet options available in these finishes:	T1 and T2 pricing includes powder coated base finish.
R Rectangular	2. Base Option	Powder coated	There is an upcharge for plated base finishes as highlighted above.
54 Depth	3. Edge Opt./Finish (only applies if trim type is metal or leather)	Premium (Polished Chrome, Satin Nickel or Oil Rubbed Bronze)	For additional stone options and pricing please contact your sales representative."
96 Width	4. Lower Layer Finish	Power Box Options	
CS01 Top Finish	5. Base Finish	Code: Description:	
PM01 Base Option	6. Power box option	NP No Power	
MC01 Edge Option/Finish	7. Table-top power finish (only applies if table-top power is selected)	UCO Undermount	
SL01 Lower Layer Finish	Trim Type	ECO Table Top Lid	
SLO1 Base Finish	N = No trim	T1E Tabletop 1-Sided Lid	
UCO Undermount	M = Metal (available in Premium and Powder Coat finishes)	T2C Tabletop 2-Sided Lid	
	L = Leather	Must select Wire Management Column and Finish:	
		Powder coated	
		Premium (Polished Chrome, Satin Nickel or Oil Rubbed Bronze)	

Rectangular Conference Tables

60" Deep Tops

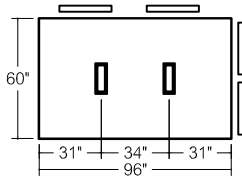
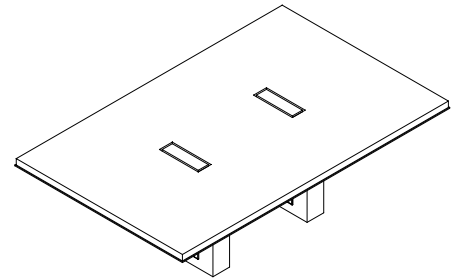

03R60X96
8 Person Table

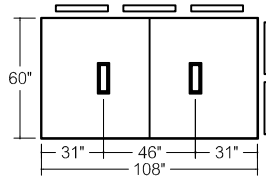

03R60X108
10 Person Table

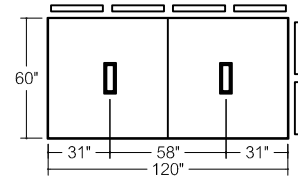

03R60X120
12 Person Table

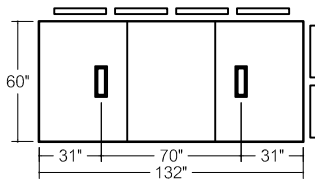

03R60X132
12 Person Table

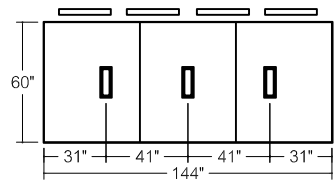

03R60X144
12 Person Table

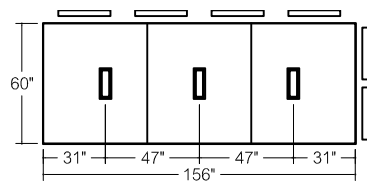

03R60X156
12 Person Table

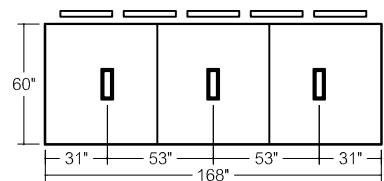

03R60X168
14 Person Table

Rectangular Conference Tables

60" Deep Tops

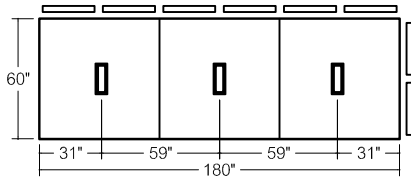
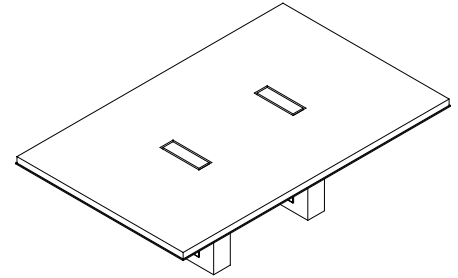

03R60X180

16 Person Table

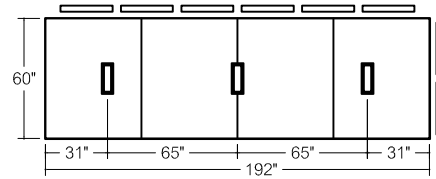

03R60X192

16 Person Table

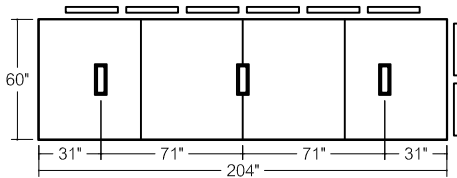

03R60X204

16 Person Table

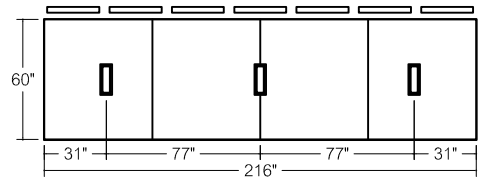

03R60X216

18 Person Table

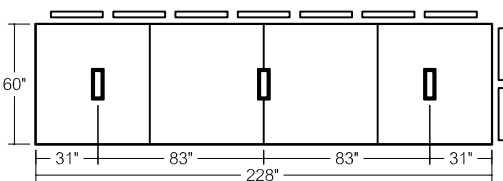

03R60X228

18 Person Table

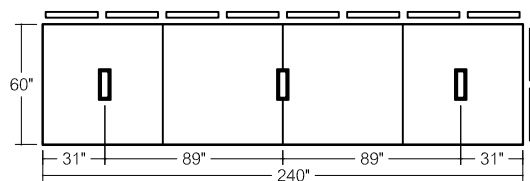

03R60X240

20 Person Table

Rectangular Conference Tables

60" Deep Tops

Veneer Top

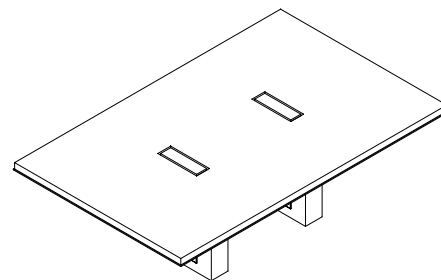

D	W	Pattern No.	T1__ Top	T2__ Top	PM01/ PM02 Edge Upcharge	PM03 Edge Upcharge	AU__ Edge Upcharge	SL__ Lower Layer	T__ Lower Layer	HG__ Lower Layer
60"	96"	03R60X96	\$20,695	\$21,802	\$1,371	\$1,371	\$2,691	\$464	\$723	\$795
60"	108"	03R60X108	21,833	23,079	1,371	1,371	2,898	550	835	919
60"	120"	03R60X120	23,140	24,525	1,371	1,371	3,105	583	869	956
60"	132"	03R60X132	28,758	30,281	1,543	1,543	3,313	669	968	1,064
60"	144"	03R60X144	30,220	31,882	1,543	1,543	3,520	742	1,028	1,131
60"	156"	03R60X156	31,403	33,201	1,543	1,543	3,727	776	1,102	1,211
60"	168"	03R60X168	32,978	34,916	2,311	2,311	3,933	835	1,160	1,277
60"	180"	03R60X180	34,178	36,253	2,311	2,311	4,141	856	1,199	1,322
60"	192"	03R60X192	39,239	41,453	2,311	2,311	4,348	921	1,307	1,439
60"	204"	03R60X204	40,396	42,751	2,311	2,311	4,554	976	1,379	1,517
60"	216"	03R60X216	41,603	44,096	2,311	2,311	4,762	1,022	1,401	1,556
60"	228"	03R60X228	42,761	45,391	2,311	2,311	4,968	1,075	1,526	1,679
60"	240"	03R60X240	43,924	46,693	2,311	2,311	5,175	1,128	1,598	1,760

Base and Base Trim Upcharges

# of bases	T1__ Base	T2__ Base	HG__ Base	OT (for MC Base Metal)	PM01/PM02 Base Metal	PM03 Base Metal
2 base	\$904	\$1,894	\$4,136	\$3,589	\$4,828	\$6,033
3 base	1,356	2,841	6,204	5,381	7,242	9,051

Order Code	Specification Information	Refer To Accessories Section	Pricing Tiers
Example: 03R60X96-T003-PM01-MC01-SL01-SL01-UCO	To order please specify pattern number including:	Please refer to Accessories section, page 211 for power details.	Please refer to Materials and Finish page 7 for specification details.
03 Highline 50 Collection	1. Top finish	Grommet options available in these finishes:	T1 and T2 pricing includes powder coated base finish.
R Rectangular	2. Base Option	Powder coated	There is an upcharge for plated base finishes as highlighted above.
60 Depth	3. Edge Opt./Finish (only applies if trim type is metal or leather)	Premium (Polished Chrome, Satin Nickel or Oil Rubbed Bronze)	For additional stone options and pricing please contact your sales representative."
96 Width	4. Lower Layer Finish	Power Box Options	
T003 Top Finish	5. Base Finish	Code: Description:	
PM01 Base Option	6. Power box option	NP No Power	
MC01 Edge Option/Finish	7. Table-top power finish (only applies if table-top power is selected)	UCO Undermount	
SL01 Lower Layer Finish	Trim Type	ECO Table Top Lid	
SL01 Base Finish	N = No trim	T1E Tabletop 1-Sided Lid	
UCO Undermount	M = Metal (available in Premium and Powder Coat finishes)	T2C Tabletop 2-Sided Lid	
	L = Leather	Must select Wire Management Column and Finish:	
		Powder coated	
		Premium (Polished Chrome, Satin Nickel or Oil Rubbed Bronze)	

Rectangular Conference Tables

60" Deep Tops
Glass Top

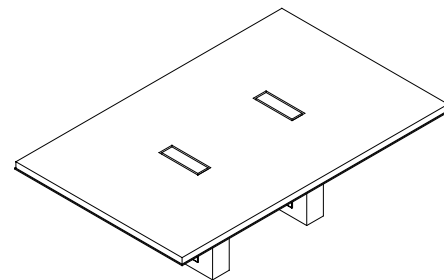

D	W	Pattern No.	GC__ Top	GE__ Top	PM01/ PM02 Edge Upcharge	PM03 Edge Upcharge	AU__ Edge Upcharge	SL__ Lower Layer	T__ Lower Layer	HG__ Lower Layer
60"	96"	03R60X96	\$26,537	\$27,541	\$1,371	\$1,371	\$2,691	\$464	\$723	\$795
60"	108"	03R60X108	28,343	29,474	1,371	1,371	2,898	550	835	919
60"	120"	03R60X120	30,328	31,582	1,371	1,371	3,105	583	869	956
60"	132"	03R60X132	36,803	38,183	1,543	1,543	3,313	669	968	1,064
60"	144"	03R60X144	38,949	40,454	1,543	1,543	3,520	742	1,028	1,131
60"	156"	03R60X156	40,801	42,431	1,543	1,543	3,727	776	1,102	1,211
60"	168"	03R60X168	43,064	44,820	2,311	2,311	3,933	835	1,160	1,277
60"	180"	03R60X180	44,935	46,816	2,311	2,311	4,141	856	1,199	1,322
60"	192"	03R60X192	50,833	52,840	2,311	2,311	4,348	921	1,307	1,439
60"	204"	03R60X204	52,659	54,791	2,311	2,311	4,554	976	1,379	1,517
60"	216"	03R60X216	54,538	56,795	2,311	2,311	4,762	1,022	1,401	1,556
60"	228"	03R60X228	56,366	58,749	2,311	2,311	4,968	1,075	1,526	1,679
60"	240"	03R60X240	58,200	60,708	2,311	2,311	5,175	1,128	1,598	1,760

Base and Base Trim Upcharges

# of bases	T1__ Base	T2__ Base	HG__ Base	OT (for MC Base Metal)	PM01/PM02 Base Metal	PM03 Base Metal
2 base	\$904	\$1,894	\$4,136	\$3,589	\$4,828	\$6,033
3 base	1,356	2,841	6,204	5,381	7,242	9,051

Order Code	Specification Information	Refer To Accessories Section	Pricing Tiers
Example: 03R60X96-GE01-PM01-MC01-SL01-SL01-UCO	To order please specify pattern number including:	Please refer to Accessories section, page 211 for power details.	Please refer to Materials and Finish page 7 for specification details.
03 Highline 50 Collection	1. Top finish	Grommet options available in these finishes:	T1 and T2 pricing includes powder coated base finish.
R Rectangular	2. Base Option	Powder coated	There is an upcharge for plated base finishes as highlighted above.
60 Depth	3. Edge Opt./Finish (only applies if trim type is metal or leather)	Premium (Polished Chrome, Satin Nickel or Oil Rubbed Bronze)	For additional stone options and pricing please contact your sales representative."
96 Width	4. Lower Layer Finish	Power Box Options	
GE01 Top Finish	5. Base Finish	Code: Description:	
PM01 Base Option	6. Power box option	NP No Power	
MC01 Edge Option/Finish	7. Table-top power finish (only applies if table-top power is selected)	UC0 Undermount	
SL01 Lower Layer Finish	Trim Type	ECO Table Top Lid	
SL01 Base Finish	N = No trim	T1E Tabletop 1-Sided Lid	
UCO Undermount	M = Metal (available in Premium and Powder Coat finishes)	T2C Tabletop 2-Sided Lid	
	L = Leather	Must select Wire Management Column and Finish:	
		Powder coated	
		Premium (Polished Chrome, Satin Nickel or Oil Rubbed Bronze)	

Rectangular Conference Tables

60" Deep Tops
Corian Top

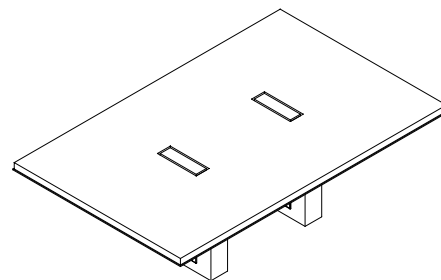

D	W	Pattern No.	CS01 Top	PM01/ PM02 Edge Upcharge	PM03 Edge Upcharge	AU__ Edge Upcharge	SL__ Lower Layer	T__ Lower Layer	HG__ Lower Layer
60"	96"	03R60X96	\$27,675	\$1,371	\$1,371	\$2,691	\$464	\$723	\$795
60"	108"	03R60X108	29,686	1,371	1,371	2,898	550	835	919
60"	120"	03R60X120	31,866	1,371	1,371	3,105	583	869	956
60"	132"	03R60X132	38,357	1,543	1,543	3,313	669	968	1,064
60"	144"	03R60X144	40,691	1,543	1,543	3,520	742	1,028	1,131
60"	156"	03R60X156	42,746	1,543	1,543	3,727	776	1,102	1,211
60"	168"	03R60X168	45,193	2,311	2,311	3,933	835	1,160	1,277
60"	180"	03R60X180	47,266	2,311	2,311	4,141	856	1,199	1,322
60"	192"	03R60X192	53,201	2,311	2,311	4,348	921	1,307	1,439
60"	204"	03R60X204	55,231	2,311	2,311	4,554	976	1,379	1,517
60"	216"	03R60X216	57,309	2,311	2,311	4,762	1,022	1,401	1,556
60"	228"	03R60X228	59,339	2,311	2,311	4,968	1,075	1,526	1,679
60"	240"	03R60X240	61,376	2,311	2,311	5,175	1,128	1,598	1,760

Base and Base Trim Upcharges

# of bases	T1__ Base	T2__ Base	HG__ Base	OT (for MC Base Metal)	PM01/PM02 Base Metal	PM03 Base Metal
2 base	\$904	\$1,894	\$4,136	\$3,589	\$4,828	\$6,033
3 base	1,356	2,841	6,204	5,381	7,242	9,051

Order Code	Specification Information	Refer To Accessories Section	Pricing Tiers
Example: 03R60X96-CS01-PM01-MC01-SL01-SL01-UCO	To order please specify pattern number including:	Please refer to Accessories section, page 211 for power details.	Please refer to Materials and Finish page 7 for specification details.
03 Highline 50 Collection	1. Top finish	Grommet options available in these finishes:	T1 and T2 pricing includes powder coated base finish.
R Rectangular	2. Base Option	Powder coated	There is an upcharge for plated base finishes as highlighted above.
60 Depth	3. Edge Opt./Finish (only applies if trim type is metal or leather)	Premium (Polished Chrome, Satin Nickel or Oil Rubbed Bronze)	For additional stone options and pricing please contact your sales representative."
96 Width	4. Lower Layer Finish	Power Box Options	
CS01 Top Finish	5. Base Finish	Code: Description:	
PM01 Base Option	6. Power box option	NP No Power	
MC01 Edge Option/Finish	7. Table-top power finish (only applies if table-top power is selected)	UC0 Undermount	
SL01 Lower Layer Finish	Trim Type	ECO Table Top Lid	
SL01 Base Finish	N = No trim	T1E Tabletop 1-Sided Lid	
UCO Undermount	M = Metal (available in Premium and Powder Coat finishes)	T2C Tabletop 2-Sided Lid	
	L = Leather	Must select Wire Management Column and Finish:	
		Powder coated	
		Premium (Polished Chrome, Satin Nickel or Oil Rubbed Bronze)	

Rectangular Conference Tables

72" Deep Tops

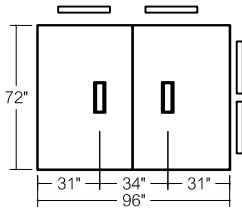
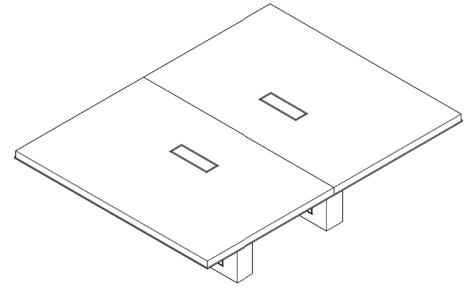

03R72X96

8 Person Table

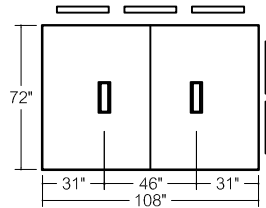

03R72X108

10 Person Table

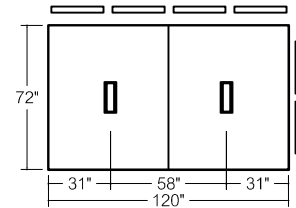

03R72X120

12 Person Table

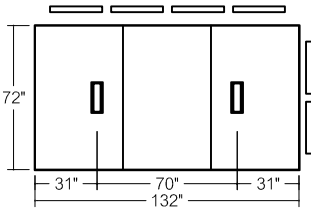

03R72X132

12 Person Table

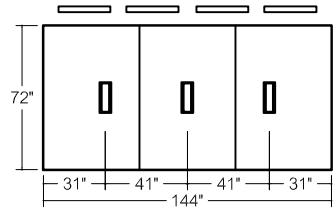

03R72X144

12 Person Table

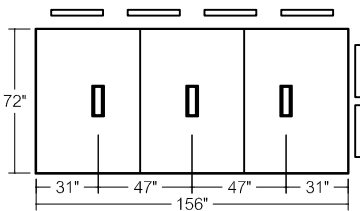

03R72X156

12 Person Table

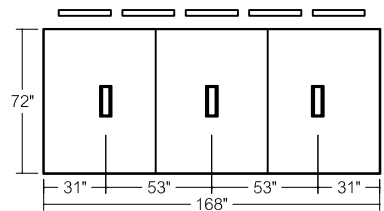

03R72X168

14 Person Table

Rectangular Conference Tables

72" Deep Tops

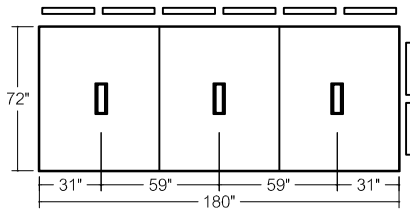
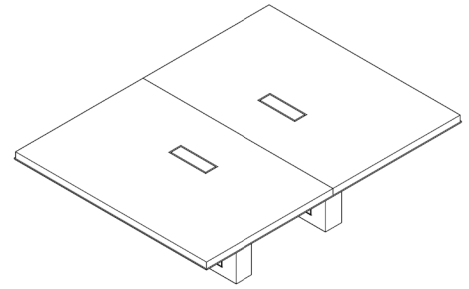

03R72X180

16 Person Table

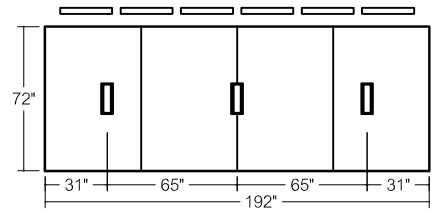

03R72X192

16 Person Table

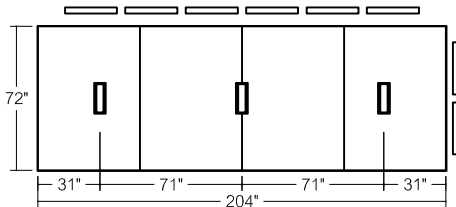

03R72X204

16 Person Table

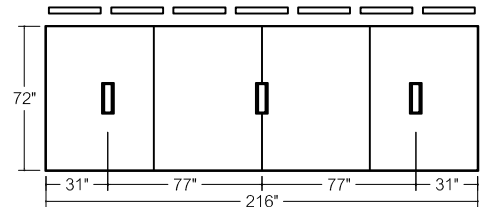

03R72X216

18 Person Table

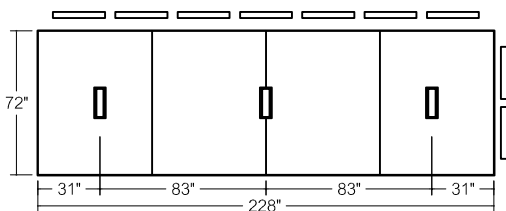

03R72X228

18 Person Table

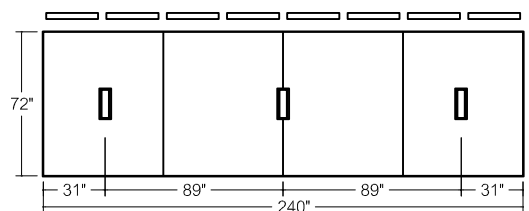

03R72X240

20 Person Table

Rectangular Conference Tables

72" Deep Tops
Veneer Top

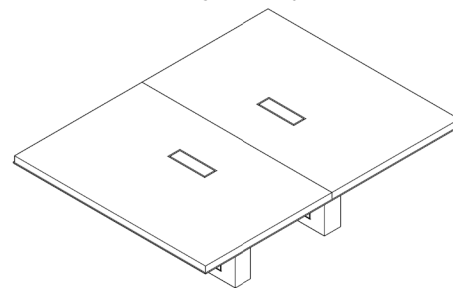

D	W	Pattern No.	T1__ Top	T2__ Top	PM01/ PM02 Edge Upcharge	PM03 Edge Upcharge	AU__ Edge Upcharge	SL__ Lower Layer	T__ Lower Layer	HG__ Lower Layer
72"	96"	03R72X96	\$22,618	\$23,946	\$1,475	\$1,475	\$2,898	\$548	\$778	\$858
72"	108"	03R72X108	24,006	25,500	1,475	1,475	3,105	623	921	1,015
72"	120"	03R72X120	25,523	27,184	1,475	1,475	3,313	684	1,008	1,109
72"	132"	03R72X132	31,408	33,236	1,563	1,563	3,398	750	1,040	1,146
72"	144"	03R72X144	33,139	35,133	1,563	1,563	3,727	765	1,059	1,165
72"	156"	03R72X156	34,499	36,659	1,563	1,563	3,933	890	1,213	1,334
72"	168"	03R72X168	36,321	38,647	2,311	2,311	4,141	942	1,307	1,439
72"	180"	03R72X180	37,723	40,215	2,311	2,311	4,348	968	1,388	1,526
72"	192"	03R72X192	43,030	45,686	2,311	2,311	4,554	1,040	1,465	1,612
72"	204"	03R72X204	44,487	47,191	2,311	2,311	4,762	1,133	1,545	1,700
72"	216"	03R72X216	45,852	48,842	2,311	2,311	4,968	1,188	1,626	1,787
72"	228"	03R72X228	47,248	50,404	2,311	2,311	5,175	1,240	1,698	1,869
72"	240"	03R72X240	50,264	53,586	2,311	2,311	5,383	1,379	1,784	1,965

Base and Base Trim Upcharges

# of bases	T1__ Base	T2__ Base	HG__ Base	OT (for MC Base Metal)	PM01/PM02 Base Metal	PM03 Base Metal
2 base	\$1,008	\$2,414	\$4,136	\$3,589	\$4,828	\$6,033
3 base	1,512	3,621	6,987	5,381	7,242	9,051

Order Code	Specification Information	Refer To Accessories Section	Pricing Tiers
Example: 03R72X96-T003-PM01-MC01-SL01-SL01-UC0	To order please specify pattern number including:	Please refer to Accessories section, page 211 for power details.	Please refer to Materials and Finish page 7 for specification details.
03 Highline 50 Collection	1. Top finish	Grommet options available in these finishes:	T1 and T2 pricing includes powder coated base finish.
R Rectangular	2. Base Option	Powder coated	There is an upcharge for plated base finishes as highlighted above.
72 Depth	3. Edge Opt./Finish (only applies if trim type is metal or leather)	Premium (Polished Chrome, Satin Nickel or Oil Rubbed Bronze)	For additional stone options and pricing please contact your sales representative."
96 Width	4. Lower Layer Finish	Power Box Options	
T003 Top Finish	5. Base Finish	Code: Description:	
PM01 Base Option	6. Power box option	NP No Power	
MC01 Edge Option/Finish	7. Table-top power finish (only applies if table-top power is selected)	UC0 Undermount	
SL01 Lower Layer Finish	Trim Type	ECO Table Top Lid	
SL01 Base Finish	N = No trim	T1E Tabletop 1-Sided Lid	
UC0 Undermount	M = Metal (available in Premium and Powder Coat finishes)	T2C Tabletop 2-Sided Lid	
	L = Leather	Must select Wire Management Column and Finish:	
		Powder coated	
		Premium (Polished Chrome, Satin Nickel or Oil Rubbed Bronze)	

Rectangular Conference Tables

72" Deep Tops

Glass Top

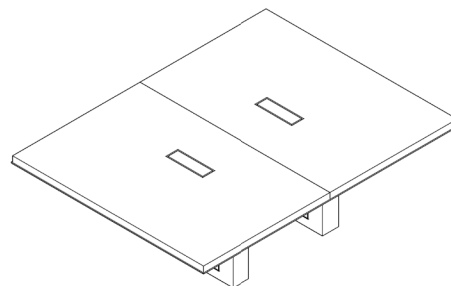

D	W	Pattern No.	GC__ Top	GE__ Top	PM01/ PM02 Edge Upcharge	PM03 Edge Upcharge	AU__ Edge Upcharge	SL__ Lower Layer	T__ Lower Layer	HG__ Lower Layer
72"	96"	03R72X96	\$29,532	\$30,737	\$1,475	\$1,475	\$2,898	\$548	\$778	\$858
72"	108"	03R72X108	31,727	33,082	1,475	1,475	3,105	623	921	1,015
72"	120"	03R72X120	34,052	35,557	1,475	1,475	3,313	684	1,008	1,109
72"	132"	03R72X132	40,931	42,587	1,563	1,563	3,398	750	1,040	1,146
72"	144"	03R72X144	43,481	45,286	1,563	1,563	3,727	765	1,059	1,165
72"	156"	03R72X156	45,643	47,600	1,563	1,563	3,933	890	1,213	1,334
72"	168"	03R72X168	48,288	50,394	2,311	2,311	4,141	942	1,307	1,439
72"	180"	03R72X180	50,494	52,752	2,311	2,311	4,348	968	1,388	1,526
72"	192"	03R72X192	56,770	59,177	2,311	2,311	4,554	1,040	1,465	1,612
72"	204"	03R72X204	59,033	61,592	2,311	2,311	4,762	1,133	1,545	1,700
72"	216"	03R72X216	61,203	64,025	2,311	2,311	4,968	1,188	1,626	1,787
72"	228"	03R72X228	63,402	66,261	2,311	2,311	5,175	1,240	1,698	1,869
72"	240"	03R72X240	67,289	70,300	2,311	2,311	5,383	1,379	1,784	1,965

Base and Base Trim Upcharges

# of bases	T1__ Base	T2__ Base	HG__ Base	OT (for MC Base Metal)	PM01/PM02 Base Metal	PM03 Base Metal
2 base	\$1,008	\$2,414	\$4,136	\$3,589	\$4,828	\$6,033
3 base	1,512	3,621	6,987	5,381	7,242	9,051

Order Code	Specification Information	Refer To Accessories Section	Pricing Tiers
Example: 03R72X96-GE01-PM01-MC01-SL01-SL01-UC0	To order please specify pattern number including:	Please refer to Accessories section, page 211 for power details.	Please refer to Materials and Finish page 7 for specification details.
03 Highline 50 Collection	1. Top finish	Grommet options available in these finishes:	T1 and T2 pricing includes powder coated base finish.
R Rectangular	2. Base Option	Powder coated	There is an upcharge for plated base finishes as highlighted above.
72 Depth	3. Edge Opt./Finish (only applies if trim type is metal or leather)	Premium (Polished Chrome, Satin Nickel or Oil Rubbed Bronze)	For additional stone options and pricing please contact your sales representative."
96 Width	4. Lower Layer Finish	Power Box Options	
GE01 Top Finish	5. Base Finish	Code: Description:	
PM01 Base Option	6. Power box option	NP No Power	
MC01 Edge Option/Finish	7. Table-top power finish (only applies if table-top power is selected)	UC0 Undermount	
SL01 Lower Layer Finish	Trim Type	ECO Table Top Lid	
SL01 Base Finish	N = No trim	T1E Tabletop 1-Sided Lid	
UC0 Undermount	M = Metal (available in Premium and Powder Coat finishes)	T2C Tabletop 2-Sided Lid	
	L = Leather	Must select Wire Management Column and Finish:	
		Powder coated	
		Premium (Polished Chrome, Satin Nickel or Oil Rubbed Bronze)	

Rectangular Conference Tables

72" Deep Tops
Corian Top

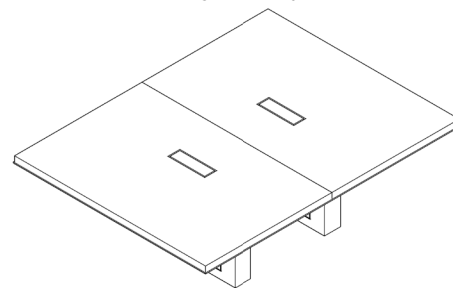

D	W	Pattern No.	CS01 Top	PM01/ PM02 Edge Upcharge	PM03 Edge Upcharge	AU__ Edge Upcharge	SL__ Lower Layer	T__ Lower Layer	HG__ Lower Layer
72"	96"	03R72X96	\$30,993	\$1,475	\$1,475	\$2,898	\$548	\$778	\$858
72"	108"	03R72X108	33,430	1,475	1,475	3,105	623	921	1,015
72"	120"	03R72X120	35,993	1,475	1,475	3,313	684	1,008	1,109
72"	132"	03R72X132	42,926	1,563	1,563	3,398	750	1,040	1,146
72"	144"	03R72X144	45,704	1,563	1,563	3,727	765	1,059	1,165
72"	156"	03R72X156	48,112	1,563	1,563	3,933	890	1,213	1,334
72"	168"	03R72X168	50,980	2,311	2,311	4,141	942	1,307	1,439
72"	180"	03R72X180	53,429	2,311	2,311	4,348	968	1,388	1,526
72"	192"	03R72X192	59,783	2,311	2,311	4,554	1,040	1,465	1,612
72"	204"	03R72X204	62,287	2,311	2,311	4,762	1,133	1,545	1,700
72"	216"	03R72X216	64,699	2,311	2,311	4,968	1,188	1,626	1,787
72"	228"	03R72X228	67,143	2,311	2,311	5,175	1,240	1,698	1,869
72"	240"	03R72X240	71,325	2,311	2,311	5,383	1,379	1,784	1,965

Base and Base Trim Upcharges

# of bases	T1__ Base	T2__ Base	HG__ Base	OT (for MC Base Metal)	PM01/PM02 Base Metal	PM03 Base Metal
2 base	\$1,008	\$2,414	\$4,136	\$3,589	\$4,828	\$6,033
3 base	1,512	3,621	6,987	5,381	7,242	9,051

Order Code	Specification Information	Refer To Accessories Section	Pricing Tiers
Example: 03R72X96-CS01-PM01-MC01-SL01-SL01-UCO	To order please specify pattern number including:	Please refer to Accessories section, page 211 for power details.	Please refer to Materials and Finish page 7 for specification details.
03 Highline 50 Collection	1. Top finish	Grommet options available in these finishes:	T1 and T2 pricing includes powder coated base finish.
R Rectangular	2. Base Option	Powder coated	There is an upcharge for plated base finishes as highlighted above.
72 Depth	3. Edge Opt./Finish (only applies if trim type is metal or leather)	Premium (Polished Chrome, Satin Nickel or Oil Rubbed Bronze)	For additional stone options and pricing please contact your sales representative."
96 Width	4. Lower Layer Finish	Power Box Options	
CS01 Top Finish	5. Base Finish	Code: Description:	
PM01 Base Option	6. Power box option	NP No Power	
MC01 Edge Option/Finish	7. Table-top power finish (only applies if table-top power is selected)	UCO Undermount	
SL01 Lower Layer Finish	Trim Type	ECO Table Top Lid	
SL01 Base Finish	N = No trim	T1E Tabletop 1-Sided Lid	
UCO Undermount	M = Metal (available in Premium and Powder Coat finishes)	T2C Tabletop 2-Sided Lid	
	L = Leather	Must select Wire Management Column and Finish:	
		Powder coated	
		Premium (Polished Chrome, Satin Nickel or Oil Rubbed Bronze)	

Boat Conference Tables

48"-72" Deep Tops

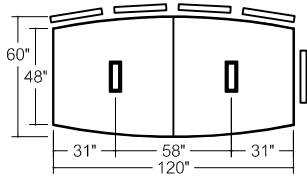
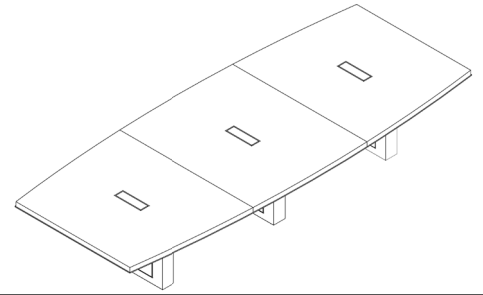

03B60X120

10 Person Table

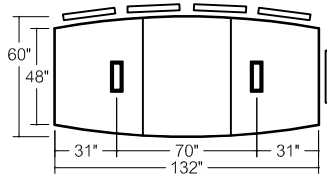

03B60X132

10 Person Table

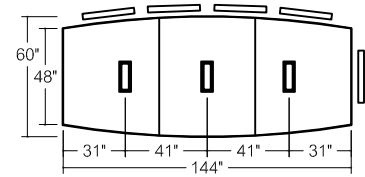

03B60X144

10 Person Table

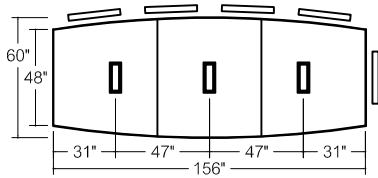

03B60X156

10 Person Table

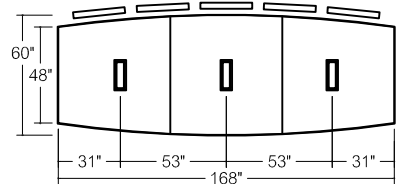

03B60X168

12 Person Table

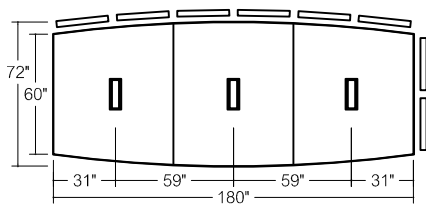

03B72X180

16 Person Table

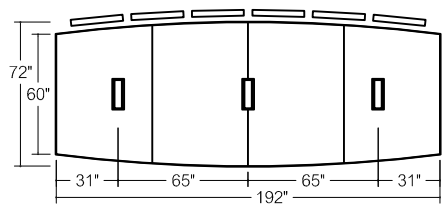

03B72X192

16 Person Table

Boat Conference Tables

48"-72" Deep Tops

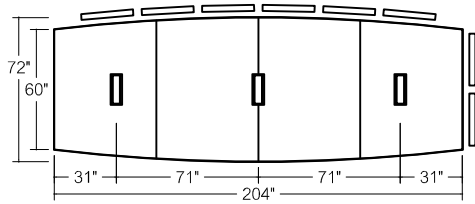
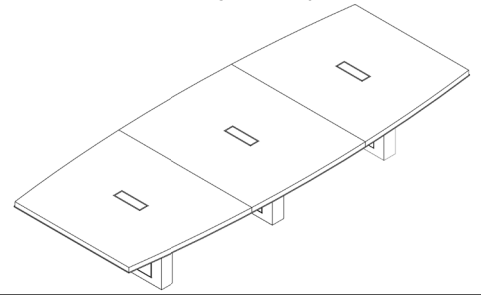

03B72X204

16 Person Table

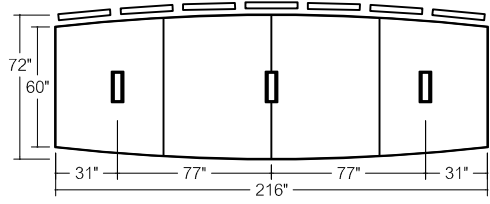

03B72X216

18 Person Table

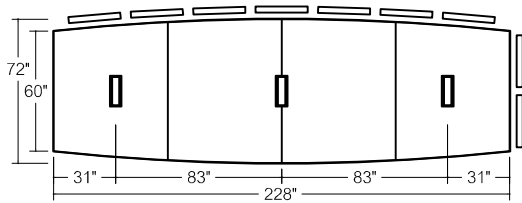

03B72X228

18 Person Table

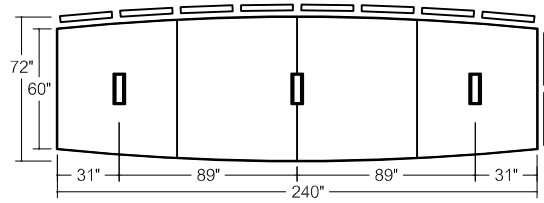

03B72X240

20 Person Table

Boat Conference Tables

48"-72" Deep Boat Tops

Veneer Top

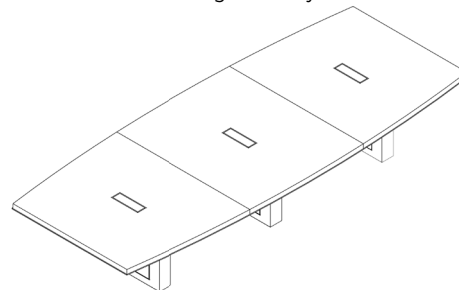

D	W	Pattern No.	T1__ Top	T2__ Top	PM01/ PM02 Edge Upcharge	PM03 Edge Upcharge	AU__ Edge Upcharge	SL__ Lower Layer	T__ Lower Layer	HG__ Lower Layer
60"	120"	03B60X120	\$28,733	\$30,117	\$2,179	\$5,503	\$3,678	\$669	\$988	\$1,087
60"	132"	03B60X132	35,072	36,595	2,934	7,322	3,937	750	1,002	1,103
60"	144"	03B60X144	36,899	38,559	2,863	7,322	4,196	802	1,075	1,182
60"	156"	03B60X156	38,255	40,054	2,862	7,321	4,454	895	1,192	1,310
60"	168"	03B60X168	39,634	41,570	2,898	7,322	4,715	988	1,340	1,474
72"	180"	03B72X180	45,691	48,183	2,910	7,322	5,231	1,114	1,553	1,707
72"	192"	03B72X192	51,482	54,139	3,415	8,931	5,492	1,207	1,565	1,723
72"	204"	03B72X204	53,093	55,916	3,415	8,931	5,751	1,321	1,750	1,927
72"	216"	03B72X216	54,824	57,813	3,415	8,978	6,010	1,379	1,784	1,965
72"	228"	03B72X228	58,954	62,109	3,462	8,978	6,268	1,388	1,883	2,071
72"	240"	03B72X240	60,482	63,804	3,462	8,978	6,529	1,506	1,965	2,160

Base and Base Trim Upcharges - small bases

# of bases	T1__ Base	T2__ Base	HG__ Base	OT (for MC Base Metal)	PM01/PM02 Base Metal	PM03 Base Metal
2 base	\$904	\$1,894	\$4,136	\$3,589	\$4,828	\$6,033
3 base	1,356	2,841	6,204	5,381	7,242	9,051

Base and Base Trim Upcharges - large bases

# of bases	T1__ Base	T2__ Base	HG__ Base	OT (for MC Base Metal)	PM01/PM02 Base Metal	PM03 Base Metal
2 base	\$1,008	\$2,414	\$4,136	\$3,589	\$4,828	\$6,033
3 base	1,512	3,621	6,987	5,381	7,242	9,051

Order Code	Specification Information	Refer To Accessories Section	Pricing Tiers
Example: 03B60X120-T003-PM01-MC01-SL01-SL01-UC0	To order please specify pattern number including:	Please refer to Accessories section, page 211 for power details.	Please refer to Materials and Finish page 7 for specification details.
03 Highline 50 Collection	1. Top finish	Grommet options available in these finishes:	T1 and T2 pricing includes powder coated base finish.
B Boat	2. Base Option	Powder coated	There is an upcharge for plated base finishes as highlighted above.
60 Depth	3. Edge Opt./Finish (only applies if trim type is metal or leather)	Premium (Polished Chrome, Satin Nickel or Oil Rubbed Bronze)	For additional stone options and pricing please contact your sales representative."
120 Width	4. Lower Layer Finish	Power Box Options	
T003 Top Finish	5. Base Finish	Code: Description:	
PM01 Base Option	6. Power box option	NP No Power	
MC01 Edge Option/Finish	7. Table-top power finish (only applies if table-top power is selected)	UC0 Undermount	
SL01 Lower Layer Finish	Trim Type	ECO Table Top Lid	
SL01 Base Finish	N = No trim	T1E Tabletop 1-Sided Lid	
UC0 Undermount	M = Metal (available in Premium and Powder Coat finishes)	T2C Tabletop 2-Sided Lid	
	L = Leather	Must select Wire Management Column and Finish:	
		Powder coated	
		Premium (Polished Chrome, Satin Nickel or Oil Rubbed Bronze)	

Boat Conference Tables

48"-72" Deep Boat Tops

Glass Top

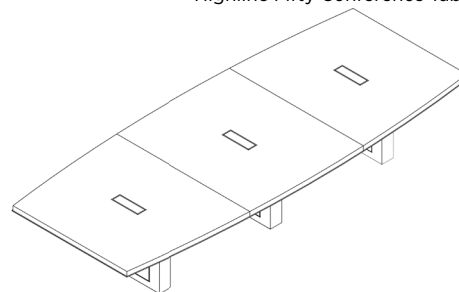

D	W	Pattern No.	GC__ Top	GE__ Top	PM01/ PM02 Edge Upcharge	PM03 Edge Upcharge	AU__ Edge Upcharge	SL__ Lower Layer	T__ Lower Layer	HG__ Lower Layer
60"	120"	03B60X120	\$39,355	\$41,237	\$2,179	\$5,503	\$3,678	\$669	\$988	\$1,087
60"	132"	03B60X132	46,904	48,973	2,934	7,322	3,937	750	1,002	1,103
60"	144"	03B60X144	49,747	52,005	2,863	7,322	4,196	802	1,075	1,182
60"	156"	03B60X156	52,102	54,547	2,862	7,321	4,454	895	1,192	1,310
60"	168"	03B60X168	54,479	57,113	2,898	7,322	4,715	988	1,340	1,474
72"	180"	03B72X180	64,556	67,943	2,910	7,322	5,231	1,114	1,553	1,707
72"	192"	03B72X192	71,720	75,332	3,415	8,931	5,492	1,207	1,565	1,723
72"	204"	03B72X204	74,529	78,367	3,415	8,931	5,751	1,321	1,750	1,927
72"	216"	03B72X216	77,461	81,525	3,415	8,978	6,010	1,379	1,784	1,965
72"	228"	03B72X228	82,894	74,641	3,462	8,978	6,268	1,388	1,883	2,071
72"	240"	03B72X240	85,617	90,132	3,462	8,978	6,529	1,506	1,965	2,160

Base and Base Trim Upcharges - small bases

# of bases	T1__ Base	T2__ Base	HG__ Base	OT (for MC Base Metal)	PM01/PM02 Base Metal	PM03 Base Metal
2 base	\$904	\$1,894	\$4,136	\$3,589	\$4,828	\$6,033
3 base	1,356	2,841	6,204	5,381	7,242	9,051

Base and Base Trim Upcharges - large bases

# of bases	T1__ Base	T2__ Base	HG__ Base	OT (for MC Base Metal)	PM01/PM02 Base Metal	PM03 Base Metal
2 base	\$1,008	\$2,414	\$4,136	\$3,589	\$4,828	\$6,033
3 base	1,512	3,621	6,987	5,381	7,242	9,051

Order Code	Specification Information	Refer To Accessories Section	Pricing Tiers
Example: 03B60X120-GE01-PM01-MC01-SL01-SL01-UCO	To order please specify pattern number including:	Please refer to Accessories section, page 211 for power details.	Please refer to Materials and Finish page 7 for specification details.
03 Highline 50 Collection	1. Top finish	Grommet options available in these finishes:	T1 and T2 pricing includes powder coated base finish.
B Boat	2. Base Option	Powder coated	There is an upcharge for plated base finishes as highlighted above.
60 Depth	3. Edge Opt./Finish (only applies if trim type is metal or leather)	Premium (Polished Chrome, Satin Nickel or Oil Rubbed Bronze)	For additional stone options and pricing please contact your sales representative."
120 Width	4. Lower Layer Finish	Power Box Options	
GE01 Top Finish	5. Base Finish	Code: Description:	
PM01 Base Option	6. Power box option	NP No Power	
MC01 Edge Option/Finish	7. Table-top power finish (only applies if table-top power is selected)	UCO Undermount	
SL01 Lower Layer Finish	Trim Type	ECO Table Top Lid	
SL01 Base Finish	N = No trim	T1E Tabletop 1-Sided Lid	
UCO Undermount	M = Metal (available in Premium and Powder Coat finishes)	T2C Tabletop 2-Sided Lid	
	L = Leather	Must select Wire Management Column and Finish:	
		Powder coated	
		Premium (Polished Chrome, Satin Nickel or Oil Rubbed Bronze)	

Boat Conference Tables

48"-72" Deep Boat Tops

Corian Top

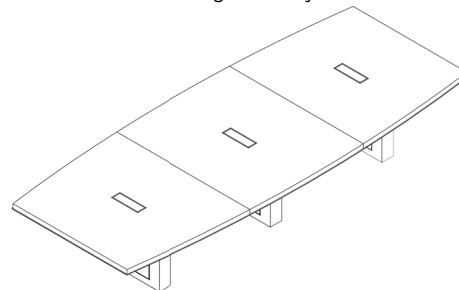

D	W	Pattern No.	CS01 Top	PM01/ PM02 Edge Upcharge	PM03 Edge Upcharge	AU__ Edge Upcharge	SL__ Lower Layer	T__ Lower Layer	HG__ Lower Layer
60"	120"	03B60X120	\$43,175	\$2,179	\$5,503	\$3,678	\$669	\$988	\$1,087
60"	132"	03B60X132	50,959	2,934	7,322	3,937	750	1,002	1,103
60"	144"	03B60X144	54,230	2,863	7,322	4,196	802	1,075	1,182
60"	156"	03B60X156	57,030	2,862	7,321	4,454	895	1,192	1,310
60"	168"	03B60X168	59,853	2,898	7,322	4,715	988	1,340	1,474
72"	180"	03B72X180	71,687	2,910	7,322	5,231	1,114	1,553	1,707
72"	192"	03B72X192	79,211	3,415	8,931	5,492	1,207	1,565	1,723
72"	204"	03B72X204	82,556	3,415	8,931	5,751	1,321	1,750	1,927
72"	216"	03B72X216	86,019	3,415	8,978	6,010	1,379	1,784	1,965
72"	228"	03B72X228	91,882	3,462	8,978	6,268	1,388	1,883	2,071
72"	240"	03B72X240	95,144	3,462	8,978	6,529	1,506	1,965	2,160

Base and Base Trim Upcharges - small bases

# of bases	T1__ Base	T2__ Base	HG__ Base	OT (for MC Base Metal)	PM01/PM02 Base Metal	PM03 Base Metal
2 base	\$904	\$1,894	\$4,136	\$3,589	\$4,828	\$6,033
3 base	1,356	2,841	6,204	5,381	7,242	9,051

Base and Base Trim Upcharges - large bases

# of bases	T1__ Base	T2__ Base	HG__ Base	OT (for MC Base Metal)	PM01/PM02 Base Metal	PM03 Base Metal
2 base	\$1,008	\$2,414	\$4,136	\$3,589	\$4,828	\$6,033
3 base	1,512	3,621	6,987	5,381	7,242	9,051

Order Code	Specification Information	Refer To Accessories Section	Pricing Tiers
Example: 03B60X120-CS01-PM01-MC01-SL01-SL01-UCO	To order please specify pattern number including:	Please refer to Accessories section, page 211 for power details.	Please refer to Materials and Finish page 7 for specification details.
03 Highline 50 Collection	1. Top finish	Grommet options available in these finishes:	T1 and T2 pricing includes powder coated base finish.
B Boat	2. Base Option	Powder coated	There is an upcharge for plated base finishes as highlighted above.
60 Depth	3. Edge Opt./Finish (only applies if trim type is metal or leather)	Premium (Polished Chrome, Satin Nickel or Oil Rubbed Bronze)	For additional stone options and pricing please contact your sales representative."
120 Width	4. Lower Layer Finish	Power Box Options	
CS01 Top Finish	5. Base Finish	Code: Description:	
PM01 Base Option	6. Power box option	NP No Power	
MC01 Edge Option/Finish	7. Table-top power finish (only applies if table-top power is selected)	UCO Undermount	
SL01 Lower Layer Finish	Trim Type	ECO Table Top Lid	
SL01 Base Finish	N = No trim	T1E Tabletop 1-Sided Lid	
UCO Undermount	M = Metal (available in Premium and Powder Coat finishes)	T2C Tabletop 2-Sided Lid	
	L = Leather	Must select Wire Management Column and Finish:	
		Powder coated	
		Premium (Polished Chrome, Satin Nickel or Oil Rubbed Bronze)	

Highline Collection

Highline Fifty Meeting Tables



DATESWEISER

General Specifications

Highline Fifty Meeting Tables

Overall Elevations and Clearance

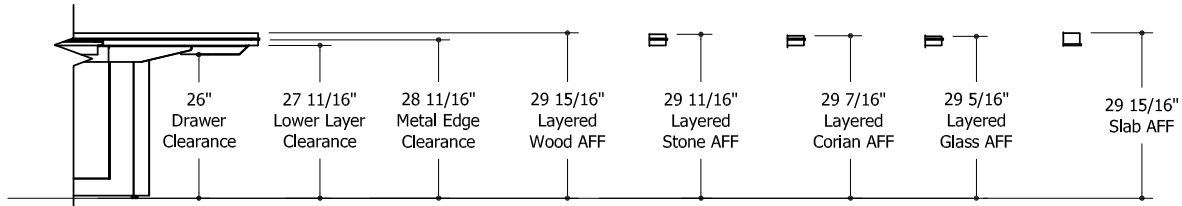

Round Table Layouts

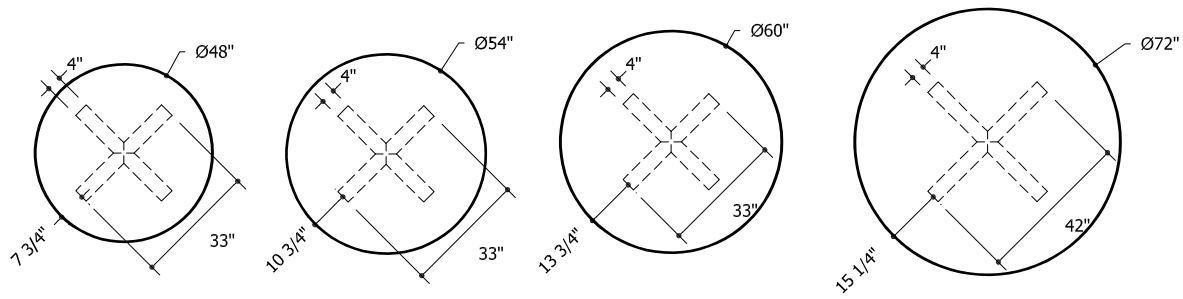

Square Table Layouts

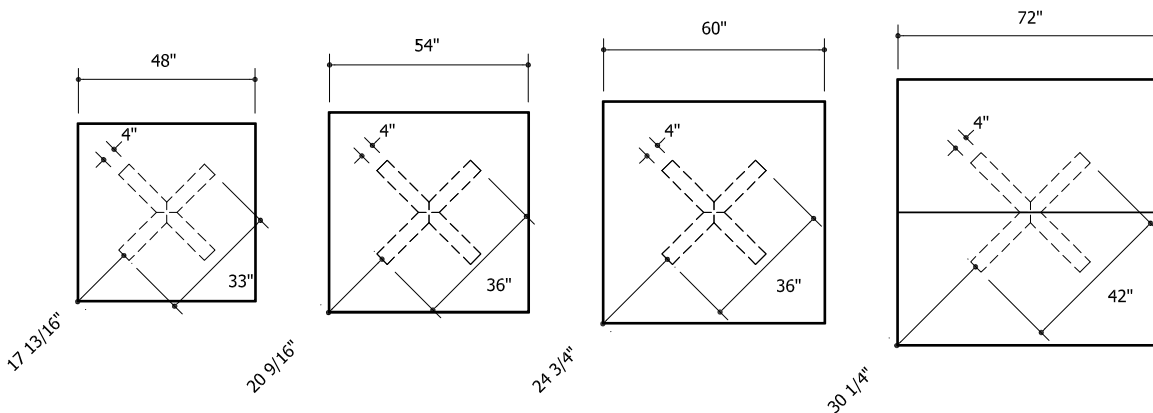

General Specifications

Highline Fifty Meeting Tables

Top Construction

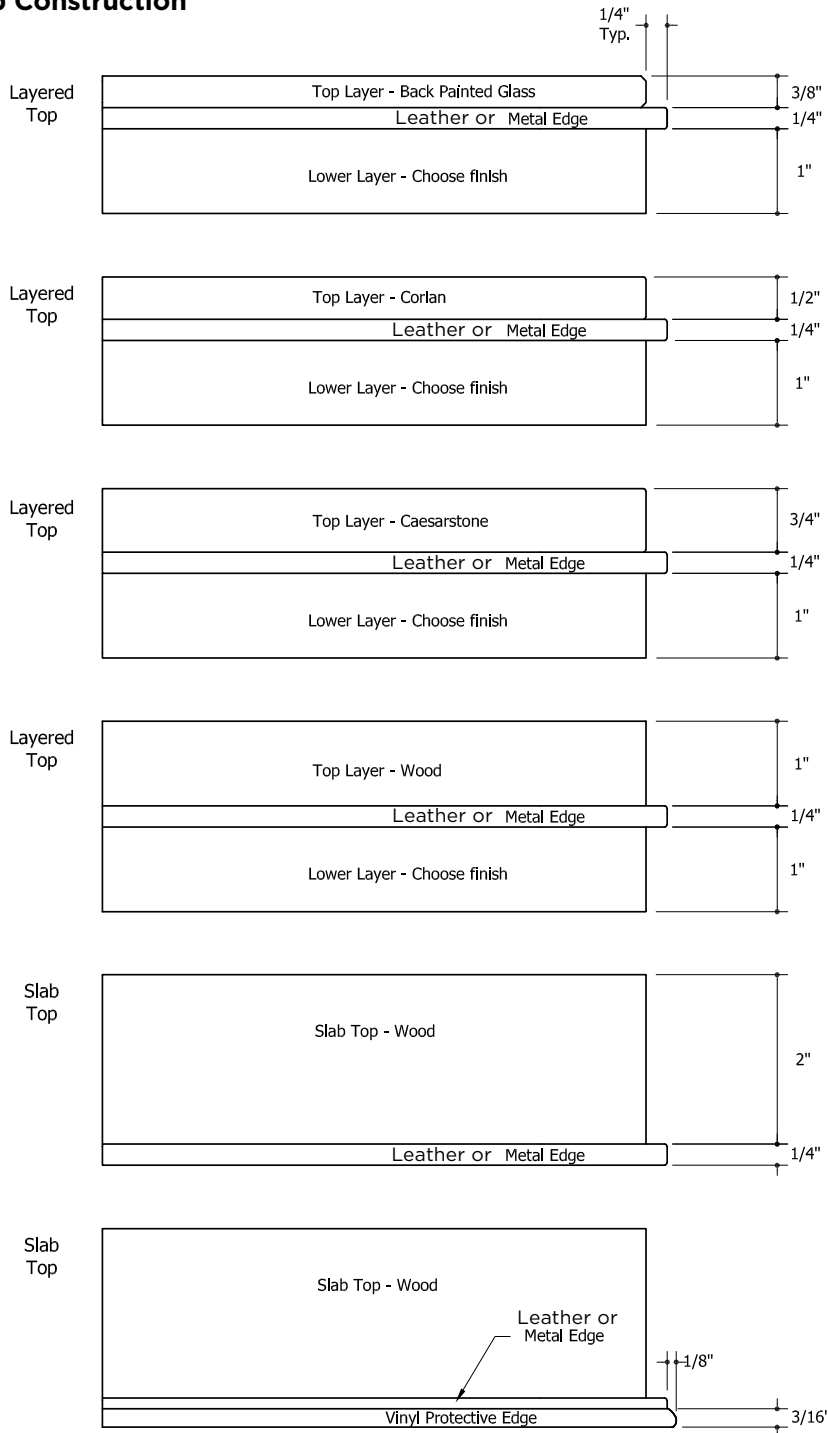

General Specifications

Highline Fifty Meeting Tables

Base Construction

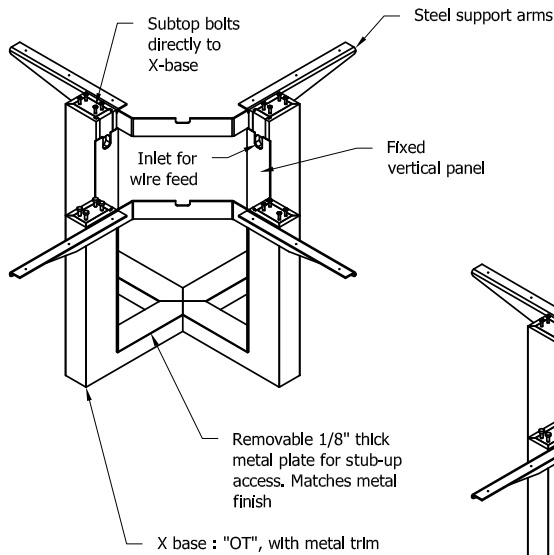

- HL03 X base :
- 33" fits - 48" Round
 - 48" Square
 - 54" Round

 - 36" fits - 54" Square
 - 60" Round
 - 60" Square

 - 42" fits - 72" Round
 - 72" Square

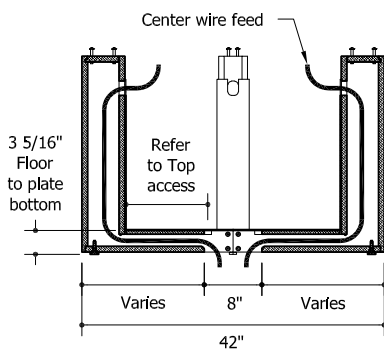
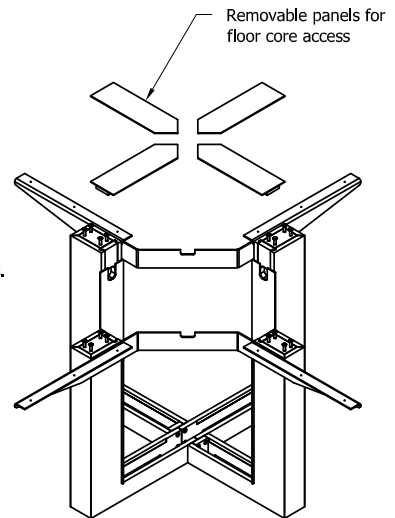
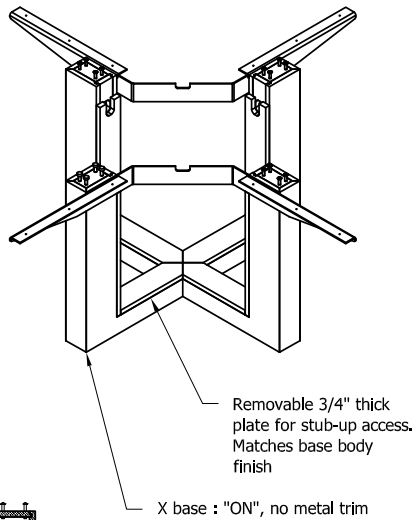

Vertical section at center of Base

- Top access:
- 33" - 2 3/8" x 6 7/8"
 - 36" - 2 3/8" x 8 3/8"
 - 42" - 2 3/8" x 11 3/8"

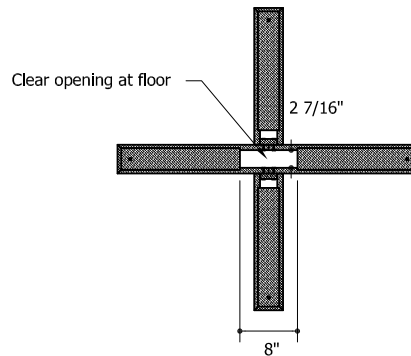

Horizontal section of typical base

General Specifications

Highline Fifty Meeting Tables

Power Drawer & Connectivity Layout

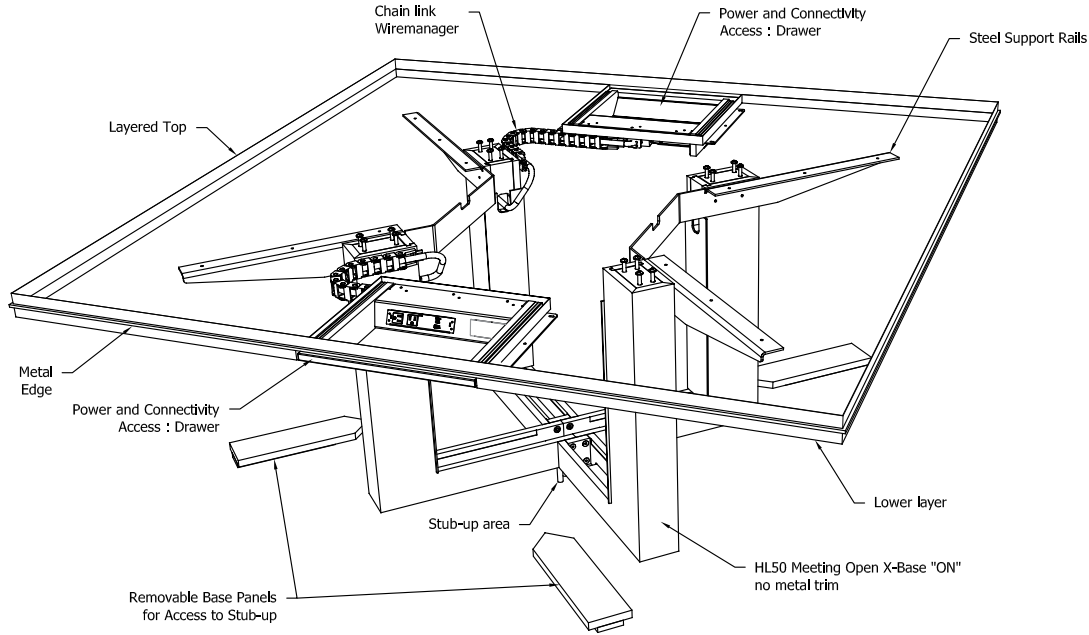

Small Power Drawer

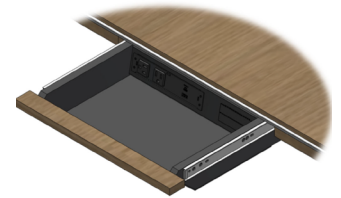

Large Power Drawer

Undermount Power & Connectivity Layout

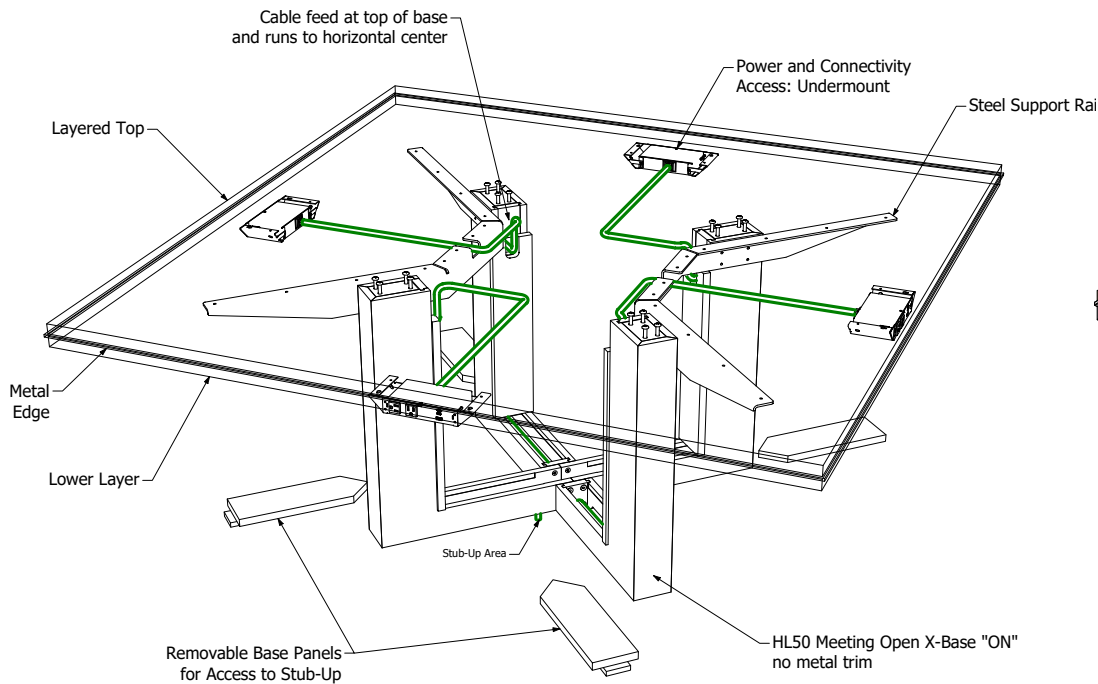

Undermount Power

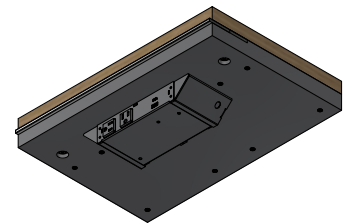

General Specifications

Highline Fifty Meeting Tables

Table Top Power & Connectivity Layout

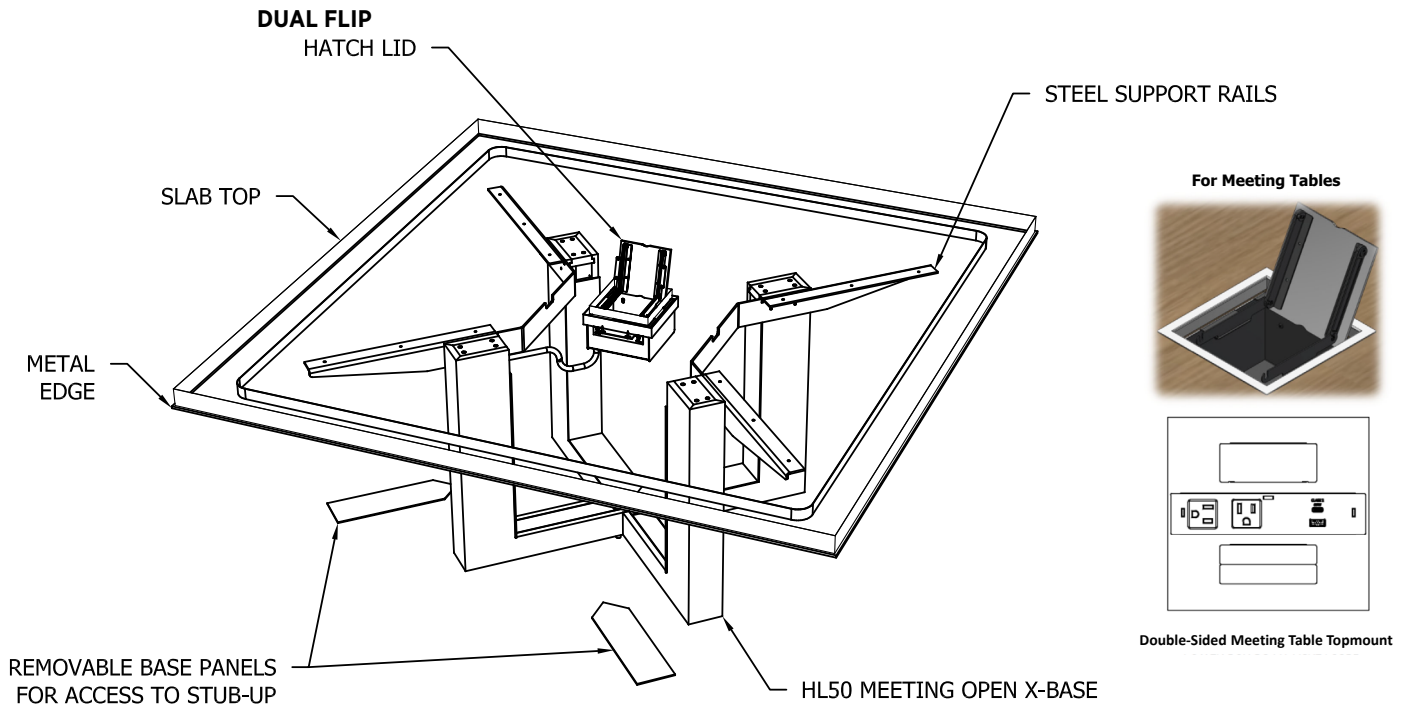

Highline Fifty Meeting Tables

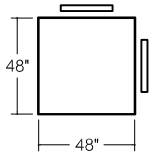
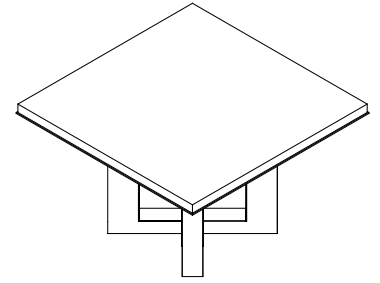

03M48S
4 Person Table

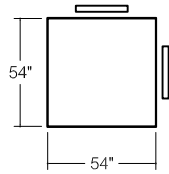

03M54S
4 Person Table

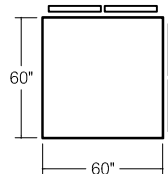

03M60S
8 Person Table

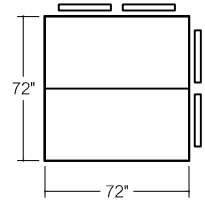

03M72S
8 Person Table

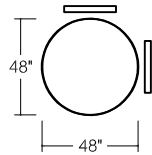

03M48C
4 Person Table

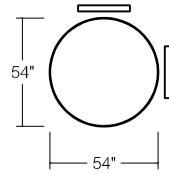

03M54C
4 Person Table

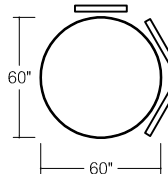

03M60C
6 Person Table

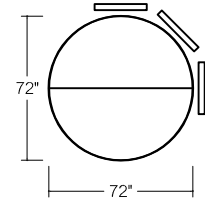

03M72C
8 Person Table

Highline Fifty Meeting Tables

Square & Round Meeting Tables

Veneer Top

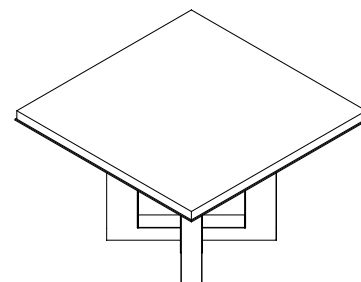

Dimension	Pattern No.	T1__ Top	T2__ Top	PM01/ PM02 Edge Upcharge	PM03 Edge Upcharge	AU__ Edge Upcharge	SL__ Lower Layer	T__ Lower Layer	HG__ Lower Layer
48"x48"	03M48S	\$15,293	\$15,736	\$1,467	\$3,661	\$1,656	\$253	383	383
54"x54"	03M54S	16,484	17,045	1,573	3,707	1,862	272	443	443
60"x60"	03M60S	17,554	18,246	1,454	3,661	2,069	365	531	531
72"x72"	03M72S	21,021	22,017	1,244	3,331	2,484	472	669	669
48"D	03M48C	18,034	18,477	352	2,160	1,633	246	379	379
54"D	03M54C	19,991	20,552	422	2,290	1,837	304	478	478
60"D	03M60C	20,993	21,685	491	2,427	2,042	353	544	544
72"D	03M72C	24,596	25,591	491	2,573	2,451	432	650	650

Base and Base Trim Upcharges

Size	T1__ Base	T2__ Base	HG__ Base	OT (for MC Base Metal)	PM01/PM02 Base Metal	PM03 Base Metal
48", 54", 60"D	\$1,590	\$2,737	\$5,464	\$5,157	\$5,549	\$6,905
72"D	1,759	3,039	6,050	5,157	5,549	6,905

Order Code	Specification Information	Refer To Accessories Section	Pricing Tiers
Example: 04M48S-T003-PM01-MC01-SL01-SL01-UCO	To order please specify pattern number including:	Please refer to Accessories section, page 211 for power details.	Please refer to Materials and Finish page 7 for specification details.
04 Highline 50 Collection	1. Top finish	Grommet options available in these finishes:	T1 and T2 pricing includes powder coated base finish.
M Meeting	2. Base Option	Powder coated	There is an upcharge for plated base finishes as highlighted above.
48 Depth	3. Edge Opt./Finish (only applies if trim type is metal or leather)	Premium (Polished Chrome, Satin Nickel or Oil Rubbed Bronze)	For additional stone options and pricing please contact your sales representative."
S Square	4. Lower Layer Finish	Power Box Options	
T003 Top Finish	5. Base Finish	Code: Description:	
PM01 Base Option	6. Power box option	NP No Power	
MC01 Edge Option/Finish	7. Table-top power finish (only applies if table-top power is selected)	UCO Undermount	
SL01 Lower Layer Finish	Trim Type	ECO Table Top Lid	
SL01 Base Finish	N = No trim	T1E Tabletop 1-Sided Lid	
UCO Undermount	M = Metal (available in Premium and Powder Coat finishes)	T2C Tabletop 2-Sided Lid	
	L = Leather	Must select Wire Management Column and Finish:	
		Powder coated	
		Premium (Polished Chrome, Satin Nickel or Oil Rubbed Bronze)	

Highline Fifty Meeting Tables

Square & Round Meeting Tables

Glass Top

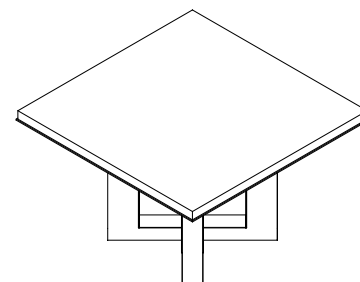

Dimension	Pattern No.	GC__ Top	GE__ Top	PM01/ PM02 Edge Upcharge	PM03 Edge Upcharge	AU__ Edge Upcharge	SL__ Lower Layer	T__ Lower Layer	HG__ Lower Layer
48"x48"	03M48S	\$17,926	\$18,328	\$1,467	\$3,661	\$1,656	\$253	383	383
54"x54"	03M54S	19,694	20,203	1,573	3,707	1,862	272	443	443
60"x60"	03M60S	21,401	22,028	1,454	3,661	2,069	365	531	531
72"x72"	03M72S	26,379	27,283	1,244	3,331	2,484	472	669	669
48"D	03M48C	21,806	22,408	352	2,160	1,633	246	379	379
54"D	03M54C	24,644	25,407	422	2,290	1,837	304	478	478
60"D	03M60C	26,584	27,524	491	2,427	2,042	353	544	544
72"D	03M72C	32,407	33,762	491	2,573	2,451	432	650	650

Base and Base Trim Upcharges

Size	T1__ Base	T2__ Base	HG__ Base	OT (for MC Base Metal)	PM01/PM02 Base Metal	PM03 Base Metal
48", 54", 60"D	\$1,590	\$2,737	\$5,464	\$5,157	\$5,549	\$6,905
72"D	1,759	3,039	6,050	5,157	5,549	6,905

Order Code	Specification Information	Refer To Accessories Section	Pricing Tiers
Example: 04M48S-GE01-PM01-MC01-SL01-SL01-UCO	To order please specify pattern number including:	Please refer to Accessories section, page 211 for power details. Grommet options available in these finishes: Powder coated Premium (Polished Chrome, Satin Nickel or Oil Rubbed Bronze) Power Box Options Code: Description: NP No Power UCO Undermount ECO Table Top Lid T1E Tabletop 1-Sided Lid T2C Tabletop 2-Sided Lid Must select Wire Management Column and Finish: Powder coated Premium (Polished Chrome, Satin Nickel or Oil Rubbed Bronze)	Please refer to Materials and Finish page 7 for specification details. T1 and T2 pricing includes powder coated base finish. There is an upcharge for plated base finishes as highlighted above. For additional stone options and pricing please contact your sales representative."
04 Highline 50 Collection	1. Top finish		
M Meeting	2. Base Option		
48 Depth	3. Edge Opt./Finish (only applies if trim type is metal or leather)		
S Square	4. Lower Layer Finish		
GE01 Top Finish	5. Base Finish		
PM01 Base Option	6. Power box option		
MC01 Edge Option/Finish	7. Table-top power finish (only applies if table-top power is selected)		
SL01 Lower Layer Finish	Trim Type N = No trim		
SL01 Base Finish	M = Metal (available in Premium and Powder Coat finishes)		
UCO Undermount	L = Leather		

Highline Fifty Meeting Tables

Square & Round Meeting Tables Corian Top

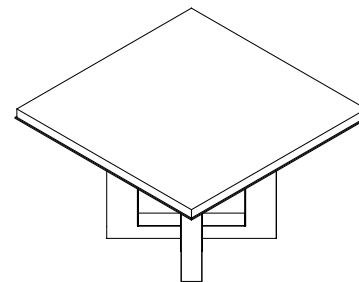

Dimension	Pattern No.	CS01 Top	PM01/ PM02 Edge Upcharge	PM03 Edge Upcharge	AU__ Edge Upcharge	SL__ Lower Layer	T__ Lower Layer	HG__ Lower Layer
48"x48"	03M48S	\$18,085	\$1,467	\$3,661	\$1,656	\$253	\$383	383
54"x54"	03M54S	20,017	1,573	3,707	1,862	272	443	443
60"x60"	03M60S	21,918	1,454	3,661	2,069	365	531	531
72"x72"	03M72S	27,303	1,244	3,331	2,484	472	669	669
48"D	03M48C	22,655	352	2,160	1,633	246	379	379
54"D	03M54C	25,840	422	2,290	1,837	304	478	478
60"D	03M60C	28,214	491	2,427	2,042	353	544	544
72"D	03M72C	34,995	491	2,573	2,451	432	650	650

Base and Base Trim Upcharges

Size	T1__ Base	T2__ Base	HG__ Base	OT (for MC Base Metal)	PM01/PM02 Base Metal	PM03 Base Metal
48", 54", 60"D	\$1,590	\$2,737	\$5,464	\$5,157	\$5,549	\$6,905
72"D	1,759	3,039	6,050	5,157	5,549	6,905

Order Code	Specification Information	Refer To Accessories Section	Pricing Tiers
Example: 04M48S-CS01-PM01-MC01-SL01-SL01-UC0	To order please specify pattern number including:	Please refer to Accessories section, page 211 for power details.	Please refer to Materials and Finish page 7 for specification details.
04 Highline 50 Collection	1. Top finish	Grommet options available in these finishes:	T1 and T2 pricing includes powder coated base finish.
M Meeting	2. Base Option	Powder coated	There is an upcharge for plated base finishes as highlighted above.
48 Depth	3. Edge Opt./Finish (only applies if trim type is metal or leather)	Premium (Polished Chrome, Satin Nickel or Oil Rubbed Bronze)	For additional stone options and pricing please contact your sales representative."
S Square	4. Lower Layer Finish	Power Box Options	
CS01 Top Finish	5. Base Finish	Code:	
PM01 Base Option	6. Power box option	NP No Power	
MC01 Edge Option/Finish	7. Table-top power finish (only applies if table-top power is selected)	UC0 Undermount	
SL01 Lower Layer Finish	Trim Type	ECO Table Top Lid	
SL01 Base Finish	N = No trim	T1E Tabletop 1-Sided Lid	
UC0 Undermount	M = Metal (available in Premium and Powder Coat finishes)	T2C Tabletop 2-Sided Lid	
	L = Leather	Must select Wire Management Column and Finish:	
		Powder coated	
		Premium (Polished Chrome, Satin Nickel or Oil Rubbed Bronze)	

Highline Collection
Highline Fifty Credenzas



DATESWEISER

General Specifications

Highline Fifty Credenzas

Credenza Elevations & Optional Tops

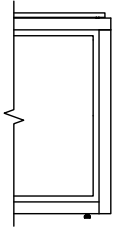

Optional Top
3/4" Caesarstone

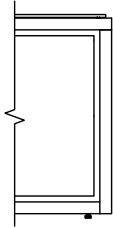

Optional Top
1/2" Cortan

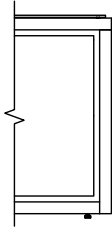

Optional Top
3/8" Glass

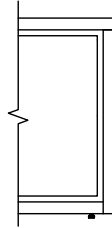

Optional Top
None

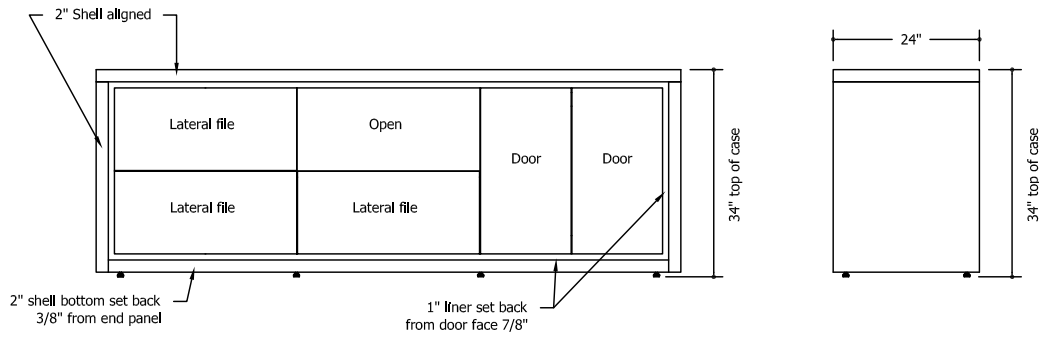
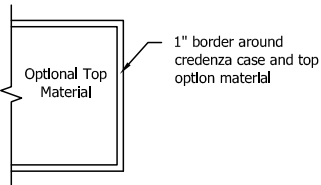

Buffet Height Credenza

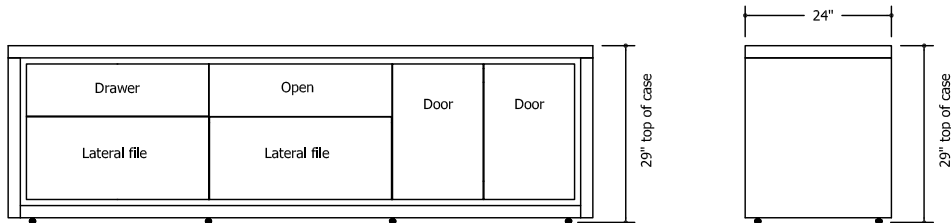

Conference Height Credenza

General Specifications

Highline Fifty Credenzas

Credenza Case Details

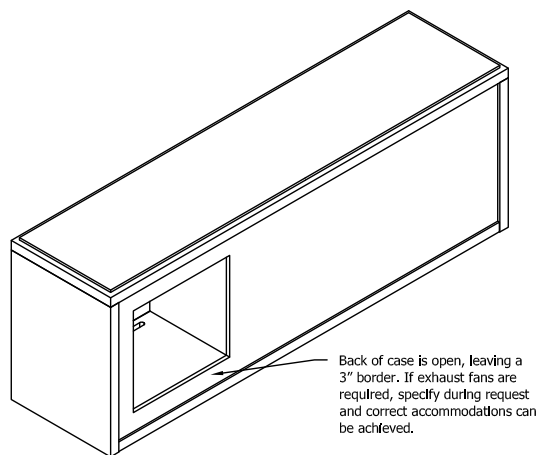

Back of Credenza

Back of case is open, leaving a 3" border. If exhaust fans are required, specify during request and correct accommodations can be achieved.

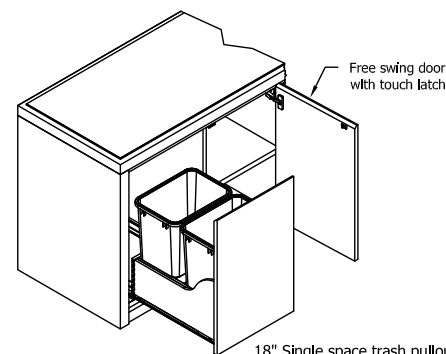

Free swing door with touch latch

18" Single space trash pullout
 - (2) 8.75 gallon receptacles
 - Front to back orientation
 - Containers are black plastic

36" Double space trash pullout
 - (4) 8.75 gallon receptacles
 - Front to back orientation
 - Containers are black plastic

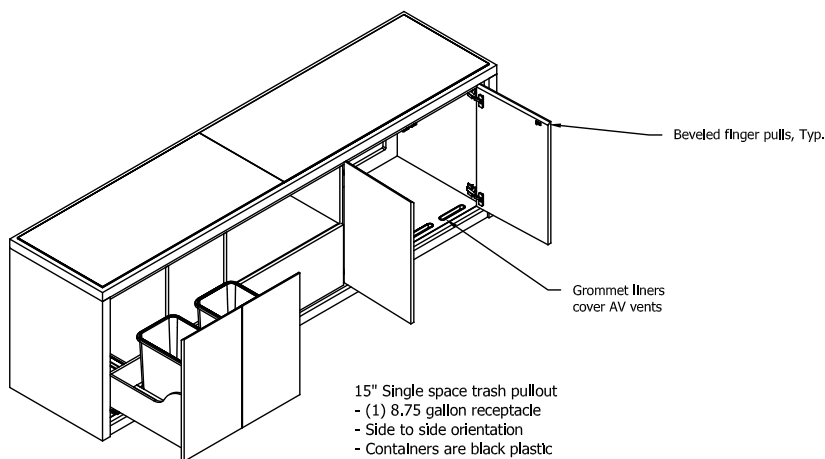

Front of Credenza

Beveled finger pulls, Typ.

Grommet liners cover AV vents

15" Single space trash pullout
 - (1) 8.75 gallon receptacle
 - Side to side orientation
 - Containers are black plastic

30" Double space trash pullout
 - (2) 8.75 gallon receptacles
 - Side to side orientation
 - Containers are black plastic

Credenza Notes

- Pulls are 45 degrees inside bevel
- All drawers have a beveled pull on back edge of each front
- Top drawer has bevel on top edge, bottom drawer has bevel at bottom edge
- All drawers are equipped with full extension slides
- All doors are equipped with self-closing hinges
- All credenza top material options are secured to the case with silicone except full clear glass (FG GC00)
- Full clear glass (FG GC00) sets on top of 1/16" bumpers located on top of case
- Trash option is pull-out only
- Pull-out trash unit is a Rev-A-Shelf product.

Audio Visual Requirements:

- Coordinate AV requirements with the interior clearance dimensions provided below to ensure fit. All AV cases have air vent grommet at the bottom front and an open back w/3" border. Consult with your AV contractor for specific component requirements. Custom solutions are available on request

- Conference height 30" Bay:
 25.75" width x 19" depth x 21.5" height
- Buffet height 30" Bay:
 25.75" width x 19" depth x 26.5" height

- Conference height 36" Bay:
 31.75" width x 19" depth x 21.5" height
- Buffet height 36" bay:
 31.75" width x 19" depth x 26.5" height

General Specifications

Conference Height Credenzas: 29"

Configurations: 15" & 30" Modules

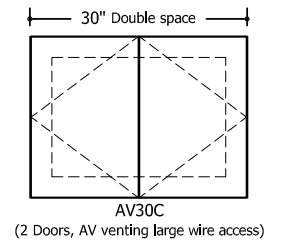
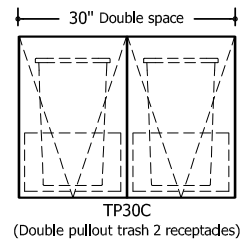
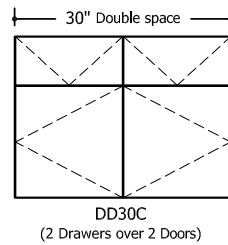
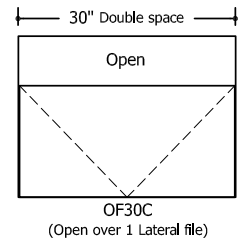
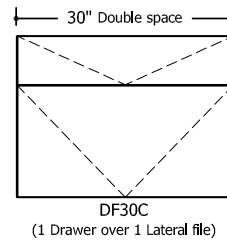
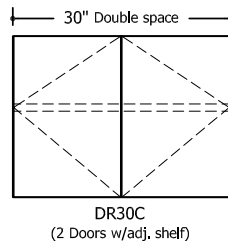
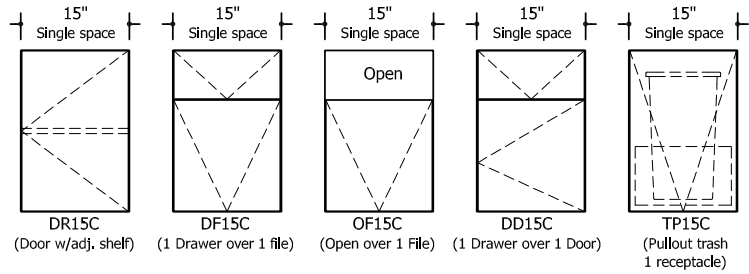
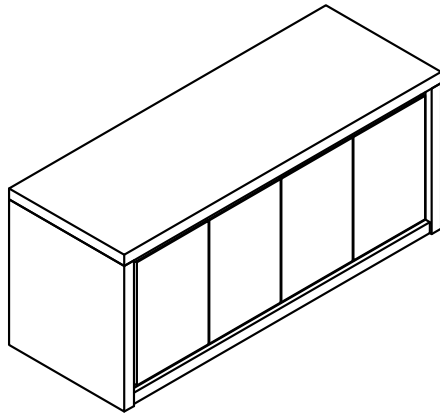

General Specifications

Conference Height Credenzas: 29"

Configurations: 18" & 36" Modules

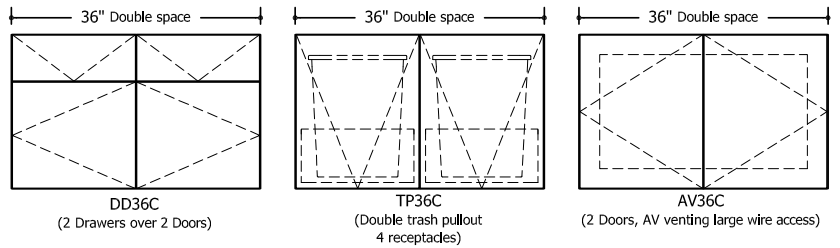
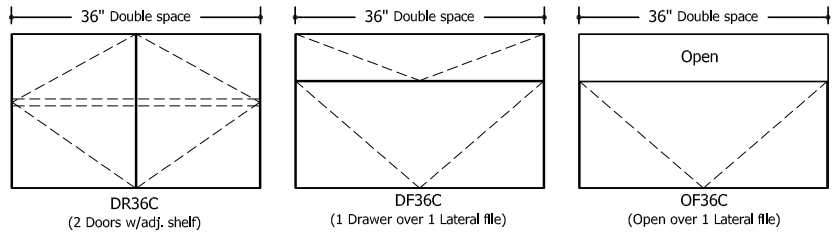
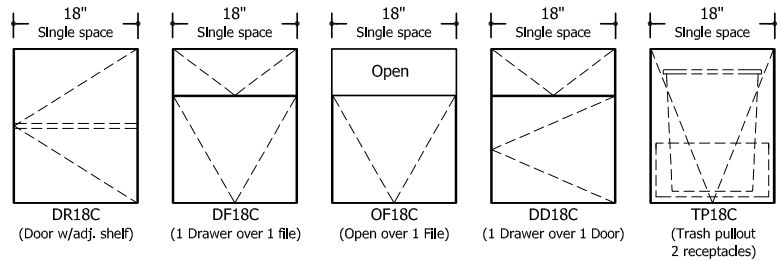
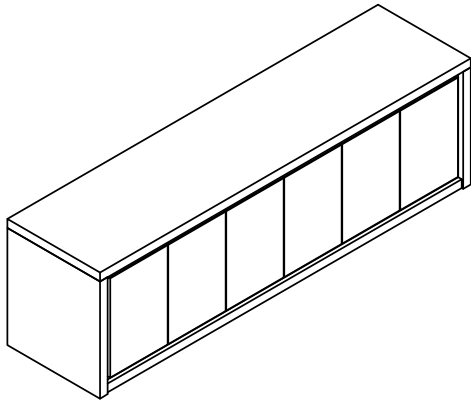

General Specifications

Buffet Height Credenzas: 34"

Configurations: 15" & 30" Modules

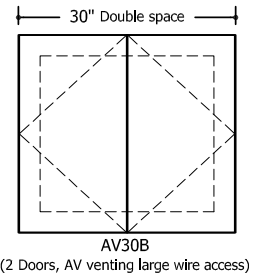
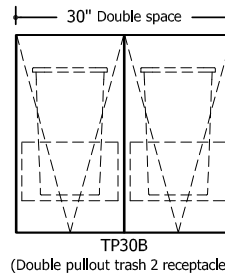
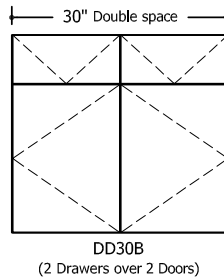
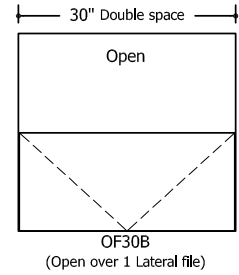
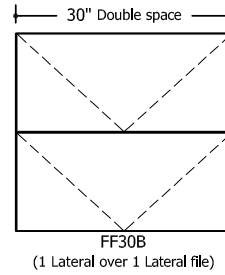
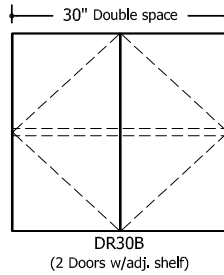
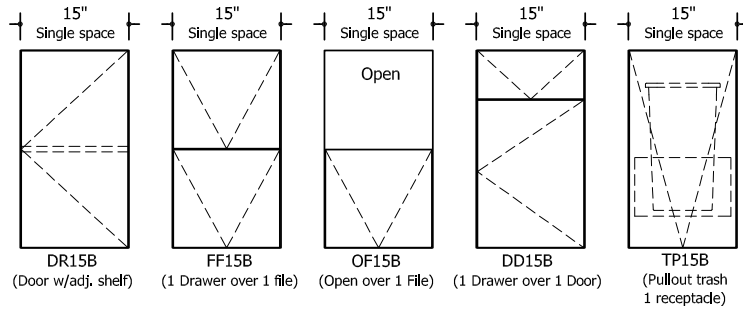
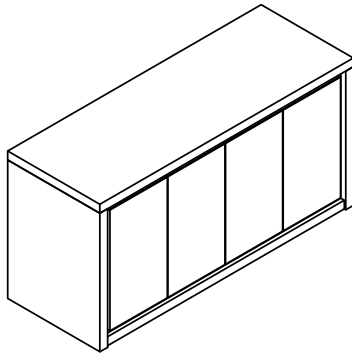

General Specifications

Buffet Height Credenzas: 34"

Configurations: 18" & 36" Modules

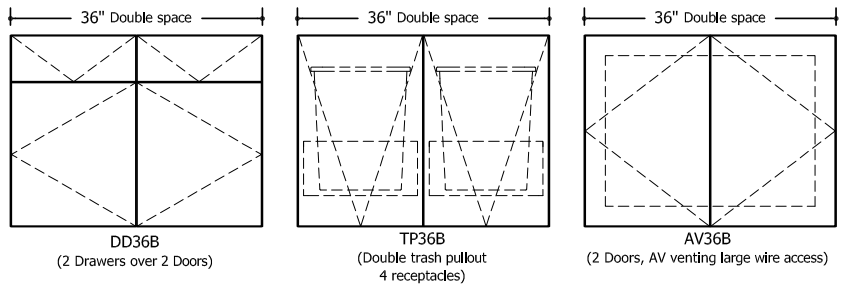
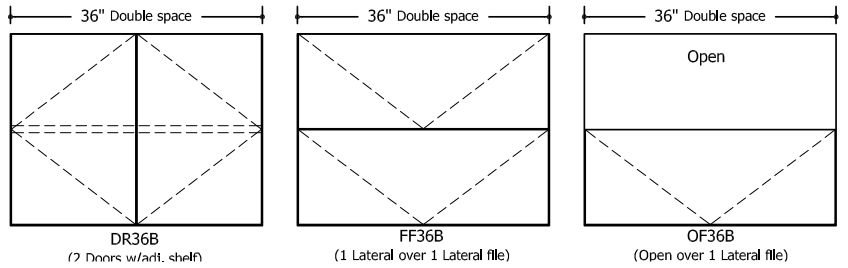
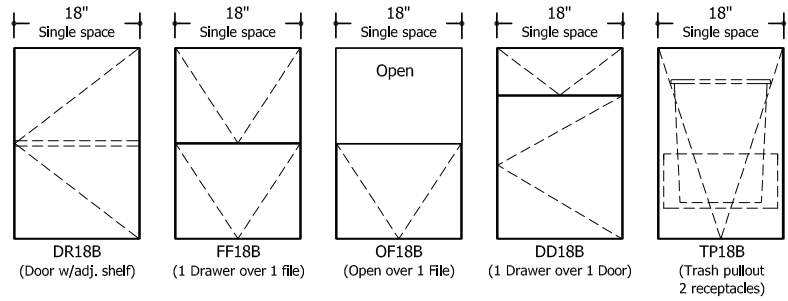
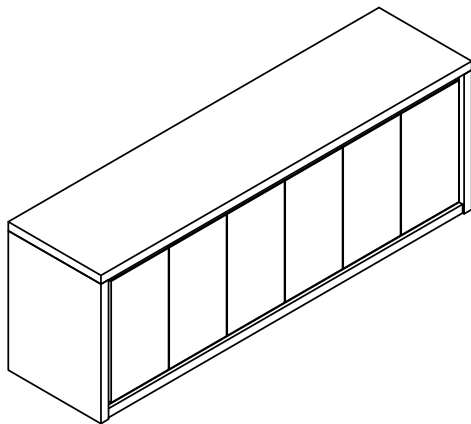

Highline Fifty Credenzas

Conference Height Credenzas

24" Deep, 29" High

**Credenzas that are over 96" will have a knockdown added.
Knockdown location may vary depending on credenza bay selections.**

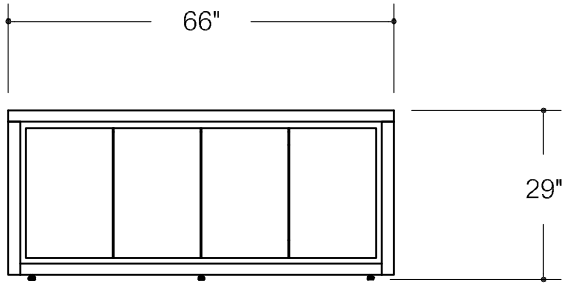

03C66C

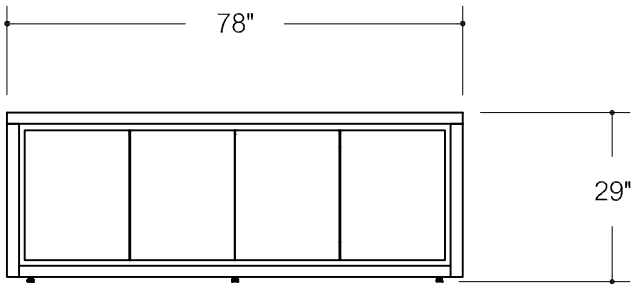

03C78C

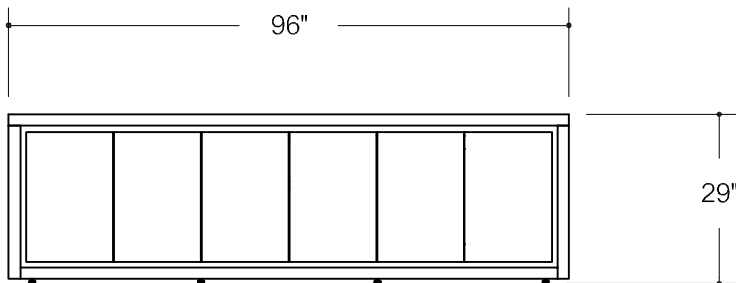

03C96C

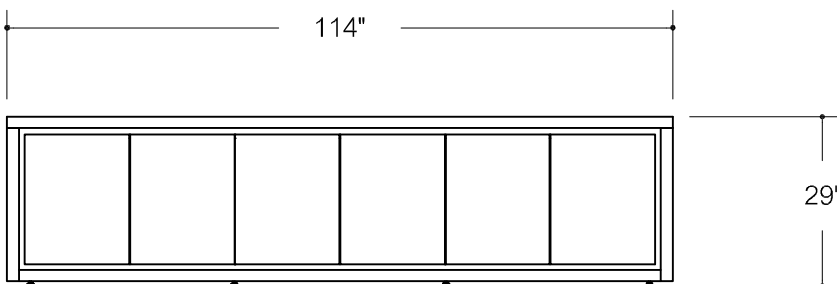

03C114C

Highline Fifty Credenzas

Conference Height Credenzas

24" Deep, 29" High

Starting price in SL finish

Pattern No.	Starting Price	T1__ Shell	T2__ Shell	HG__ Shell	MC__/ PM01/ PM02	PM03 Reveal	T1__ Interior	T2__ Interior	T1__ Face	T2__ Face	HG__ Face
					Reveal						
03C66C	\$14,600	\$2,212	\$3,827	\$7,407	\$714	\$714	\$1,344	\$1,615	\$659	\$1,282	\$2,784
03C78C	15,770	2,342	4,112	8,111	714	714	1,507	2,965	659	1,282	2,784
03C96C	18,918	2,580	4,590	9,196	714	714	1,927	3,761	951	1,853	4,527
03C114C	20,627	2,769	5,002	10,291	821	821	2,058	4,194	1,011	2,071	4,861

Top Upcharges

Pattern

Pattern No.	GC00 Top	GC__ Top	GE__ Top	CS01 Top
03C66C	\$2,547	\$3,034	\$3,282	\$3,359
03C78C	2,554	3,041	3,290	3,368
03C96C	3,172	3,754	4,071	4,235
03C114C	4,870	5,689	6,097	6,218

Configuration Upcharges

Pattern No.	Description	Price	Pattern No.	Description	Price
03DR15C	15" Door w/ Adjustable Shelf	\$-	03DR18C	18" Door w/ Adjustable Shelf	\$-
03DF15C	15" Lateral File over Lateral File	211	03DF18C	18" Lateral File over Lateral File	216
03OF15C	15" Open Over File	197	03OF18C	18" Open Over File	204
03DD15C	15" Drawer Over Door	257	03DD18C	18" Drawer Over Door	264
03TP15C	15" Trash Pull Out	665	03TP18C	18" Trash Pull Out	672
03DR30C	30" Doors w/ Adjustable Shelf	-	03DR36C	36" Doors w/ Adjustable Shelf	-
03DF30C	30" File Over File	421	03DF36C	36" File Over File	435
03OF30C	30" Open Over File	394	03OF36C	36" Open Over File	408
03DD30C	30" Drawer Over Doors	517	03DD36C	36" Drawer Over Doors	531
03TP30C	30" Trash Pull Out	1,330	03TP36C	36" Trash Pull Out	1,344
03AV30C	30" AV Case	475	03AV36C	36" AV Case	569

Highline Fifty Credenzas

Buffet Height Credenzas

24" Deep, 34" High

**Credenzas that are over 96" will have a knockdown added.
Knockdown location may vary depending on credenza bay selections.**

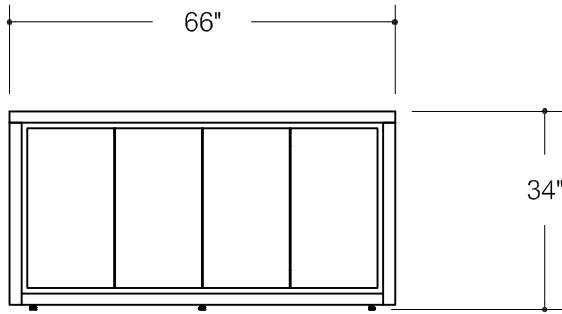

03C66B

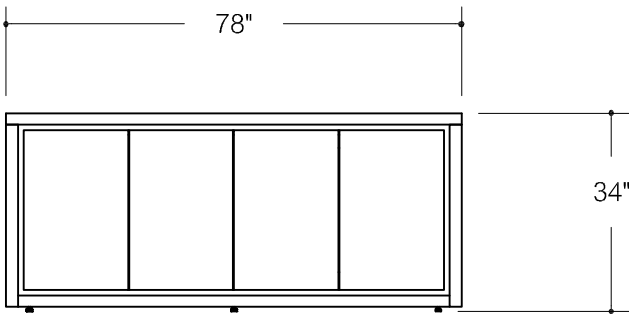

03C78B

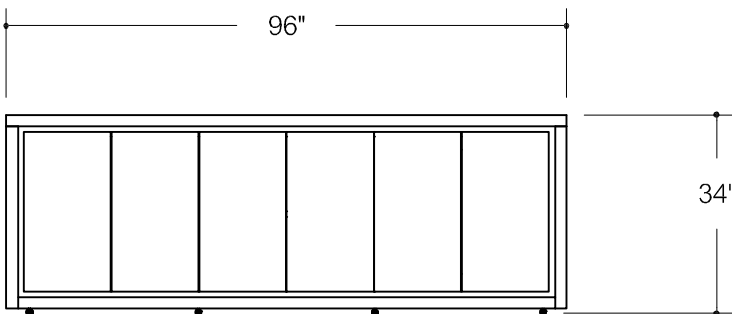

03C96B

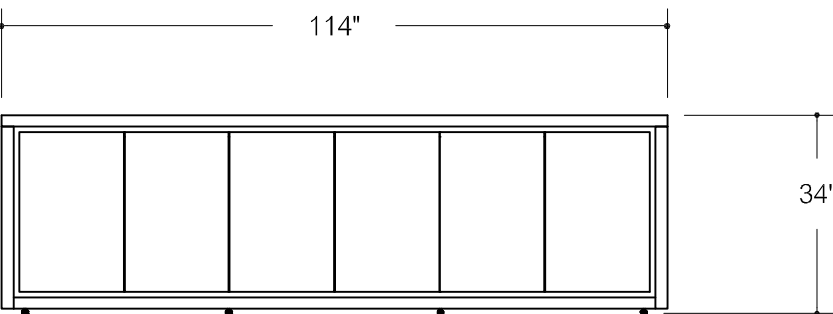

03C114B

Highline Fifty Credenzas

Buffet Height Credenzas

24" Deep, 34" High

Starting price in SL finish

Pattern No.	Starting Price	T1__ Shell	T2__ Shell	HG__ Shell	MC__/ PM01/ PM02	PM03 Reveal	T1__ Interior	T2__ Interior	T1__ Face	T2__ Face	HG__ Face
					Reveal						
03C66B	\$14,600	\$2,212	\$3,827	\$7,407	\$714	\$714	\$1,344	\$1,615	\$659	\$1,282	\$2,784
03C78B	15,770	2,342	4,112	8,111	714	714	1,507	2,965	659	1,282	2,784
03C96B	18,918	2,580	4,590	9,196	714	714	1,927	3,761	951	1,853	4,527
03C114B	20,627	2,769	5,002	10,291	821	821	2,058	4,194	1,011	2,071	4,861

Top Upcharges

Pattern

Pattern No.	GC00 Top	GC__ Top	GE__ Top	CS01 Top
03C66B	\$2,547	\$3,034	\$3,282	\$3,359
03C78B	2,554	3,041	3,290	3,368
03C96B	3,172	3,754	4,071	4,235
03C114B	4,870	5,689	6,097	6,218

Configuration Upcharges

Pattern No.	Description	Price
03DR15B	15" Door w/ Adjustable Shelf	\$-
03FF15B	15" Lateral File over Lateral File	211
03OF15B	15" Open Over File	197
03DD15B	15" Drawer Over Door	257
03TP15B	15" Trash Pull Out	665
03DR30B	30" Doors w/ Adjustable Shelf	-
03FF30B	30" File Over File	421
03OF30B	30" Open Over File	394
03DD30B	30" Drawer Over Doors	517
03TP30B	30" Trash Pull Out	1,330
03AV30B	30" AV Case	475

Pattern No.	Description	Price
03DR18B	18" Door w/ Adjustable Shelf	\$-
03FF18B	18" Lateral File over Lateral File	216
03OF18B	18" Open Over File	204
03DD18B	18" Drawer Over Door	264
03TP18B	18" Trash Pull Out	672
03DR36B	36" Doors w/ Adjustable Shelf	-
03FF36B	36" File Over File	435
03OF36B	36" Open Over File	408
03DD36B	36" Drawer Over Doors	531
03TP36B	36" Trash Pull Out	1,344
03AV36B	36" AV Case	569

Highline Collection

Highline Twenty-Five Credenzas



DATESWEISER

General Specifications

Highline Twenty-Five Credenzas

Credenza Elevations & Optional Tops

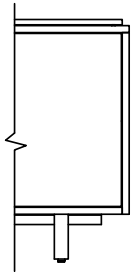

Optional Top
3/4" Caesarstone

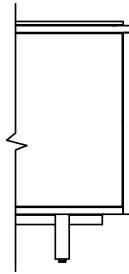

Optional Top
1/2" Corian

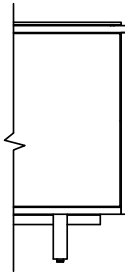

Optional Top
3/8" Glass

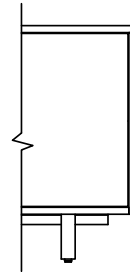

Optional Top
None

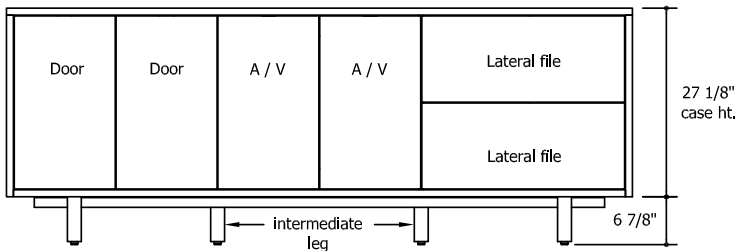
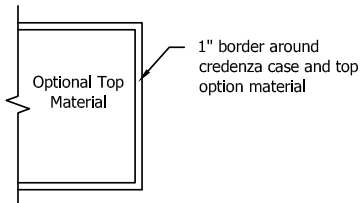

Buffet Height Credenza

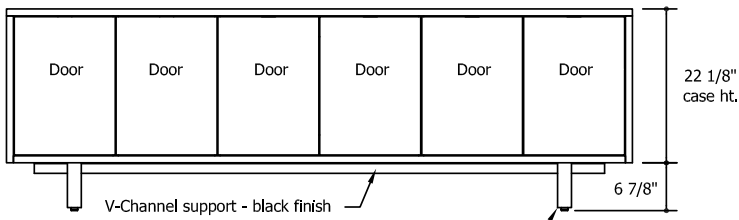
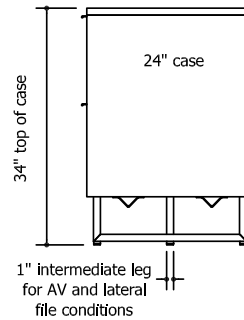

Conference Height Credenza

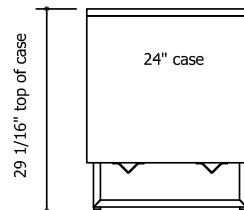

General Specifications

Highline Twenty-Five Credenzas

Credenza Case Details

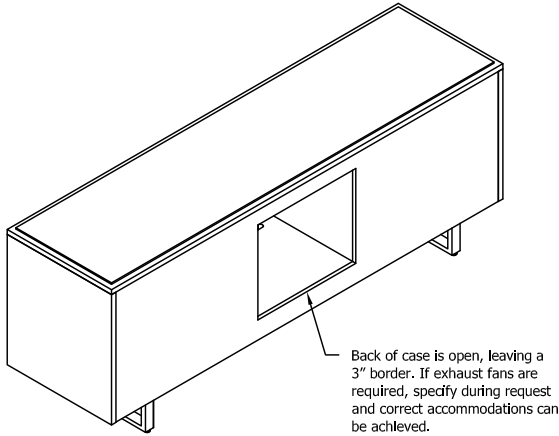

Back of Credenza

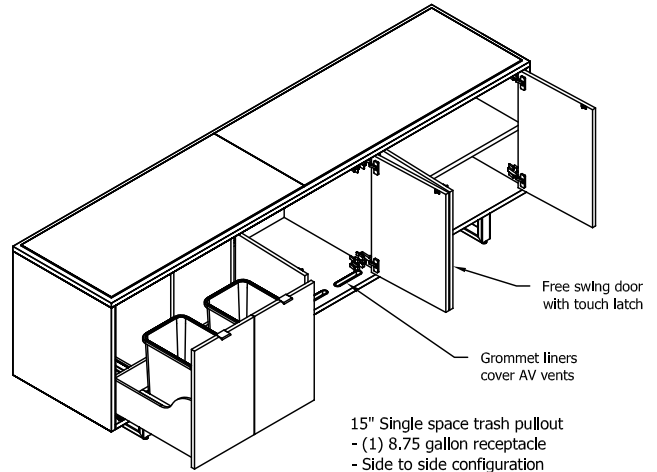

Front of Credenza

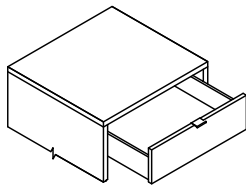

Drawer with 2" tab pull



2" tab pull

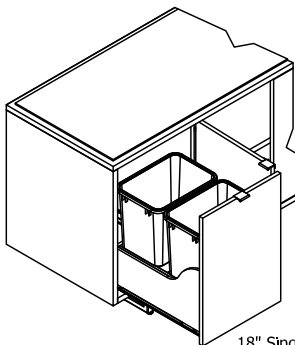

18" Single space trash pullout
- (2) 8.75 gallon receptacles
- Front to back orientation
- Containers are black plastic

36" Double space trash pullout
- (4) 8.75 gallon receptacles
- Front to back orientation
- Containers are black plastic

Credenza Notes:

- 2" metal pulls to compliment metal legs
- All drawers have a 2" tab pull that is located in the center of the top edge of each front
- All drawers use full extension slides
- All doors use free swing hinges and touch latches.
- All credenza top material options are secured to the case with silicone except full clear glass (FG GC00)
- Full clear glass (FG CG00) sets on top of 1/16" bumpers located on top of case
- Trash option is pull-out only
- Pull-out trash unit is a Rev-A-Shelf product.

Audio Visual Requirements:

- Coordinate AV requirements with the interior clearance dimensions provided below to ensure fit. All AV cases have air vent grommet at the bottom front and an open back width 3" border. Consult with your AV contractor for specific component requirements. Custom solutions are available on request

- Conference height 30" Bay:
25.15" width x 21.25" depth x 19.18" height
- Buffet height 30" Bay:
25.15" width x 21.25" depth x 24.18" height
- Conference height 36" Bay:
31.13" width x 21.25" depth x 19.18" height
- Buffet height 36" Bay:
31.13" width x 21.25" depth x 24.18" height

General Specifications

Conference Height Credenzas: 29"

Configurations: 15" & 30" Modules

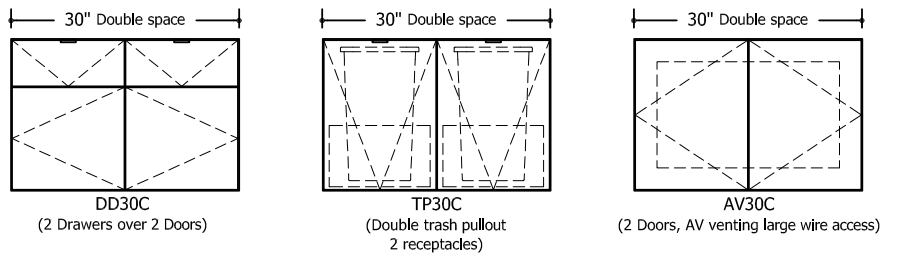
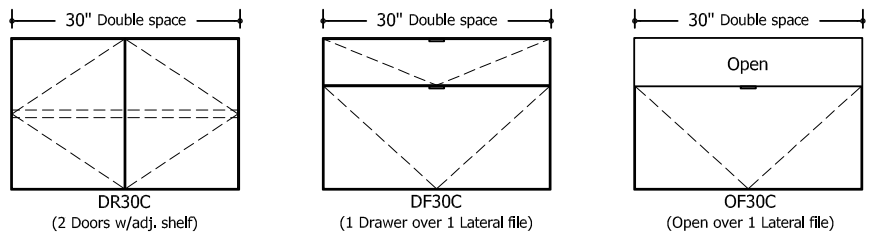
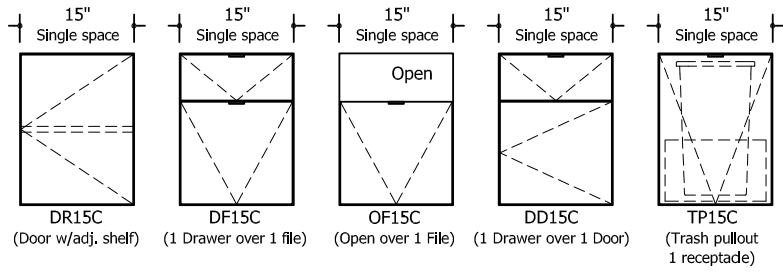
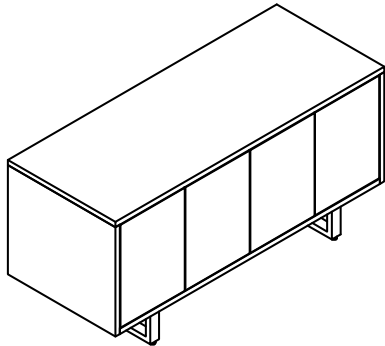

General Specifications

Conference Height Credenzas: 29"

Configurations: 18" & 36" Modules

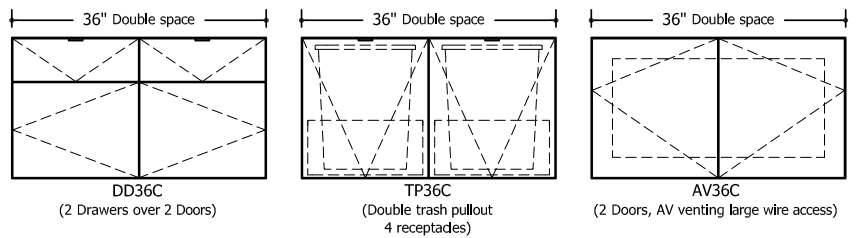
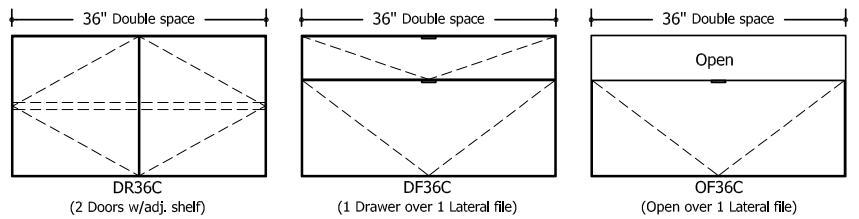
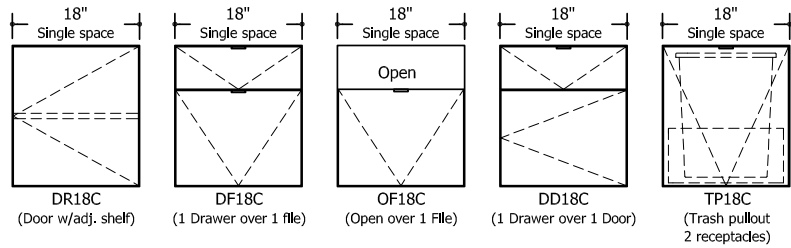
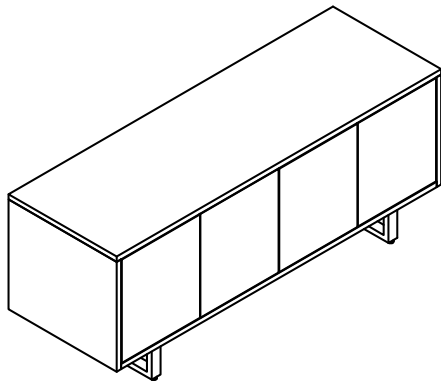

General Specifications

Buffet Height Credenzas: 34"

Configurations: 15" & 30" Modules

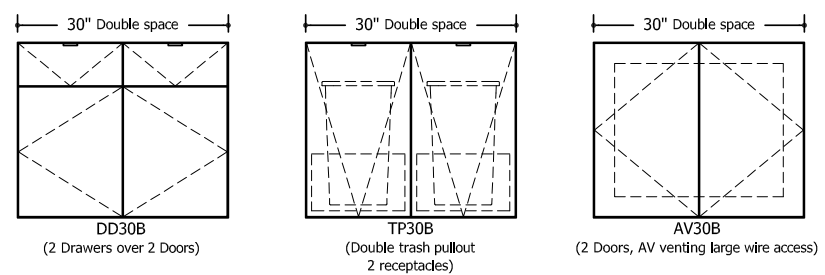
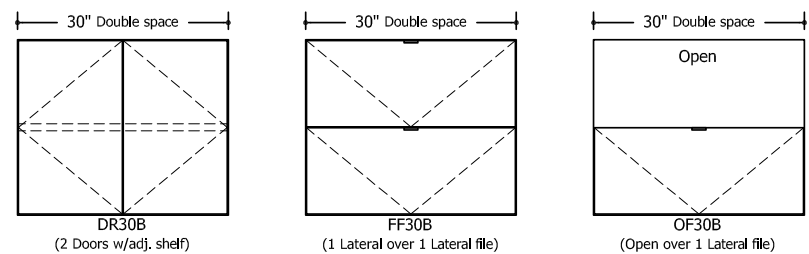
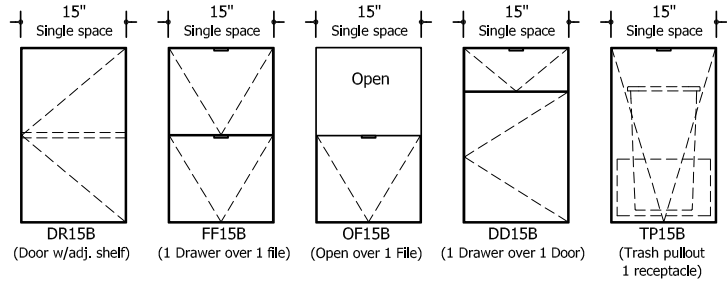
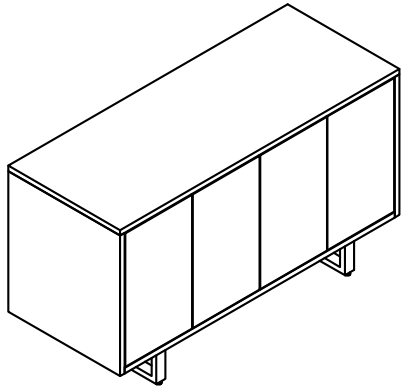

General Specifications

Buffet Height Credenzas: 34"

Configurations: 18" & 36" Modules

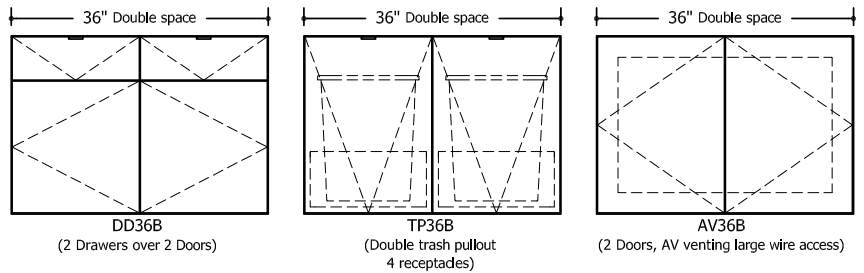
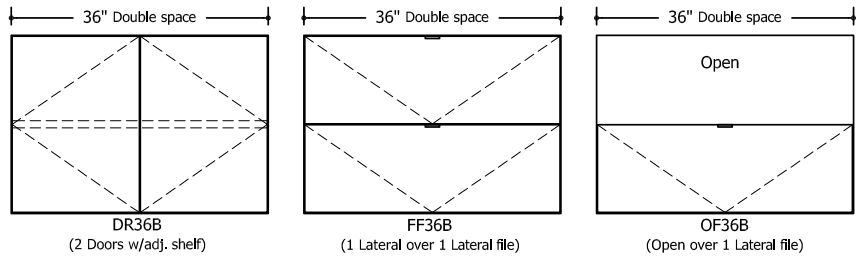
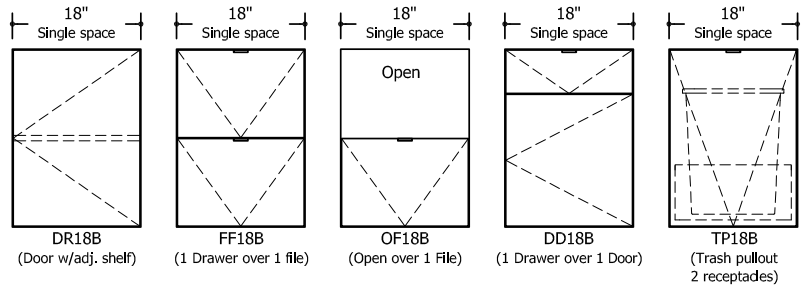
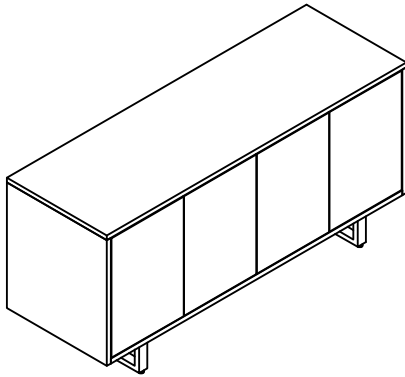

Highline Twenty-Five Credenzas

Conference Height Credenzas

24" Deep, 29" High

**Credenzas that are over 96" will have a knockdown added.
Knockdown location may vary depending on credenza bay selections.**

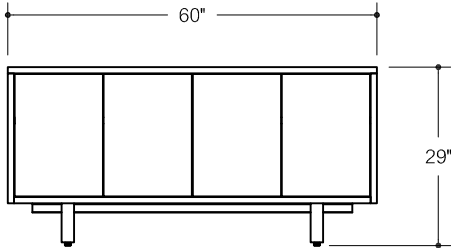

04C60C

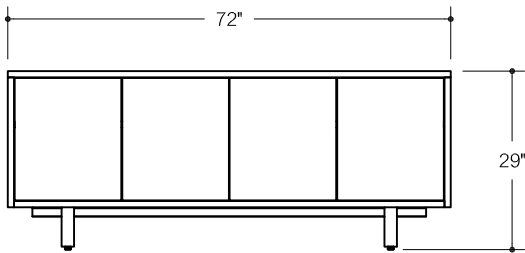

04C72C

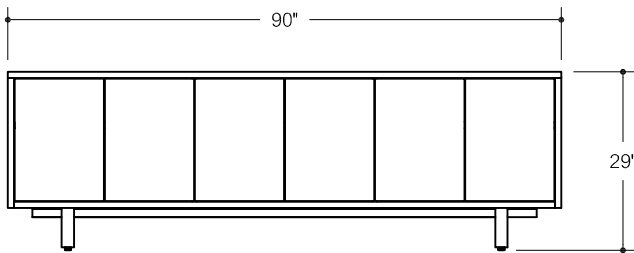

04C90C

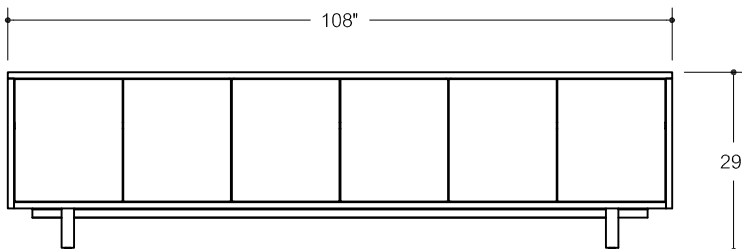

04C108C

Highline Twenty-Five Credenzas

Conference Height Credenzas

24" Deep, 29" High

Starting price in SL finish and MC base

L	Pattern No.	Starting Price	T1__ Shell	T2__ Shell	HG__ Shell	PM01/ PM02 Base	PM03 Base	T1__ Face	T2__ Face	HG__ Face
60"	04C60C	\$10,287	\$2,161	\$4,672	\$10,308	\$428	\$801	\$536	\$1,169	\$2,577
72"	04C72C	10,837	2,369	5,114	11,832	428	801	591	1,282	2,959
90"	04C90C	13,198	2,973	6,482	13,966	428	801	745	1,625	3,489
108"	04C108C	14,050	3,268	7,315	16,247	428	801	819	1,833	4,061

Top Upcharges

Pattern

No.	GC00 Top	GC__ Top	GE__ Top	CS01 Top
04C60C	\$2,411	\$2,813	\$3,028	\$3,161
04C72C	2,532	3,081	3,336	3,670
04C90C	2,774	3,495	3,805	4,586
04C108C	3,496	5,007	5,375	5,638

Configuration Upcharges

Pattern No.	Description	Price	Pattern No.	Description	Price
04DR15C	15" Door w/ Adjustable Shelf	\$-	04DR18C	18" Door w/ Adjustable Shelf	\$-
04DF15C	15" Lateral File over Lateral File	239	04DF18C	18" Lateral File over Lateral File	267
04OF15C	15" Open Over File	201	04OF18C	18" Open Over File	235
04DD15C	15" Drawer Over Door	397	04DD18C	18" Drawer Over Door	426
04TP15C	15" Trash Pull Out	695	04TP18C	18" Trash Pull Out	735
04DR30C	30" Doors w/ Adjustable Shelf	-	04DR36C	36" Doors w/ Adjustable Shelf	-
04DF30C	30" File Over File	477	04DF36C	36" File Over File	530
04OF30C	30" Open Over File	403	04OF36C	36" Open Over File	472
04DD30C	30" Drawer Over Doors	792	04DD36C	36" Drawer Over Doors	852
04TP30C	30" Trash Pull Out	1,388	04TP36C	36" Trash Pull Out	1,471
04AV30C	30" AV Case	472	04AV36C	36" AV Case	563

Highline Twenty-Five Credenzas

Buffet Height Credenzas

24" Deep, 34" High

**Credenzas that are over 96" will have a knockdown added.
Knockdown location may vary depending on credenza bay selections.**

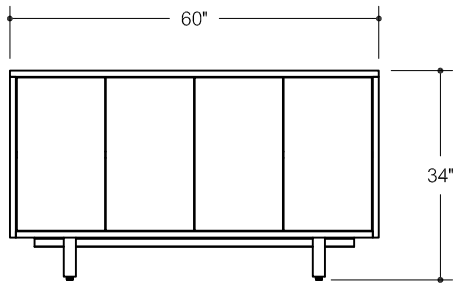

04C60B

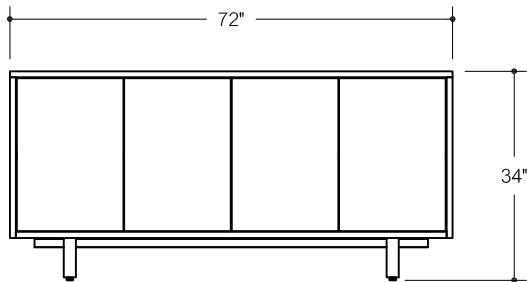

04C72B

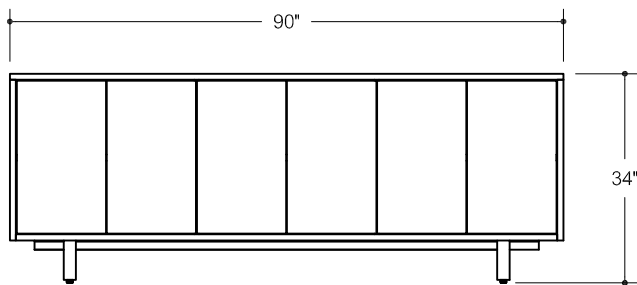

04C90B

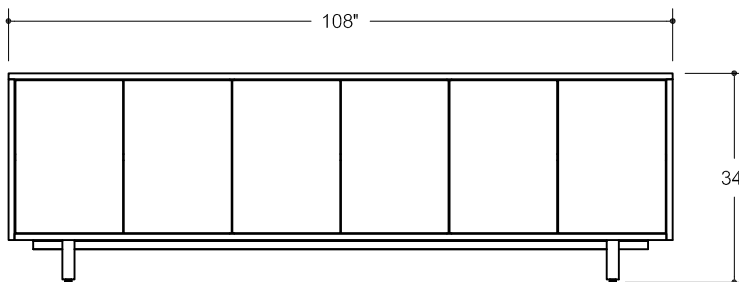

04C108B

Highline Twenty-Five Credenzas

Buffet Height Credenzas

24" Deep, 34" High

Starting price in SL finish and MC base

L	Pattern No.	Starting Price	PM01/							
			T1__ Shell	T2__ Shell	HG__ Shell	PM02 Base	PM03 Base	T1__ Face	T2__ Face	HG__ Face
60"	04C60B	\$10,287	\$2,161	\$4,672	\$10,308	\$428	\$801	\$536	\$1,169	\$2,577
72"	04C72B	10,837	2,369	5,114	11,832	428	801	591	1,282	2,959
90"	04C90B	13,198	2,973	6,482	13,966	428	801	745	1,625	3,489
108"	04C108B	14,050	3,268	7,315	16,247	428	801	819	1,833	4,061

Top Upcharges

Pattern

No.	GC00 Top	GC__ Top	GE__ Top	CS01 Top
04C60B	\$2,411	\$2,813	\$3,028	\$3,161
04C72B	2,532	3,081	3,336	3,670
04C90B	2,774	3,495	3,805	4,586
04C108B	3,496	5,007	5,375	5,638

Configuration Upcharges

Pattern No.	Description	Price	Pattern No.	Description	Price
04DR15B	15" Door w/ Adjustable Shelf	\$-	04DR18B	18" Door w/ Adjustable Shelf	\$-
04FF15B	15" Lateral File over Lateral File	239	04FF18B	18" Lateral File over Lateral File	267
04OF15B	15" Open Over File	201	04OF18B	18" Open Over File	235
04DD15B	15" Drawer Over Door	397	04DD18B	18" Drawer Over Door	426
04TP15B	15" Trash Pull Out	695	04TP18B	18" Trash Pull Out	735
04DR30B	30" Doors w/ Adjustable Shelf	-	04DR36B	36" Doors w/ Adjustable Shelf	-
04FF30B	30" File Over File	477	04FF36B	36" File Over File	530
04OF30B	30" Open Over File	403	04OF36B	36" Open Over File	472
04DD30B	30" Drawer Over Doors	792	04DD36B	36" Drawer Over Doors	852
04TP30B	30" Trash Pull Out	1,388	04TP36B	36" Trash Pull Out	1,471
04AV30B	30" AV Case	472	04AV36B	36" AV Case	563

Highline Collection

Highline Vector Conference Tables



DATESWEISER

General Specifications

Highline Vector Conference Tables

Power & Connectivity Layout

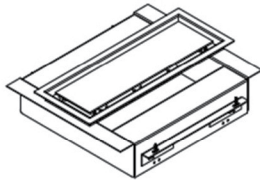

DOUBLE-HINGED TOPMOUNT

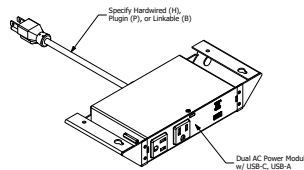

UNDER-MOUNT BOX

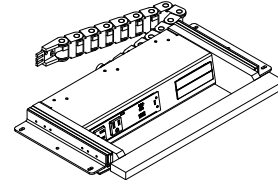

POWER DRAWER

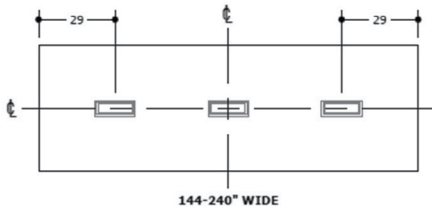

144-240" WIDE

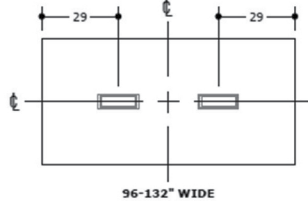

96-132" WIDE

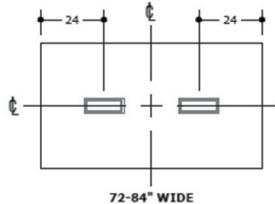

72-84" WIDE

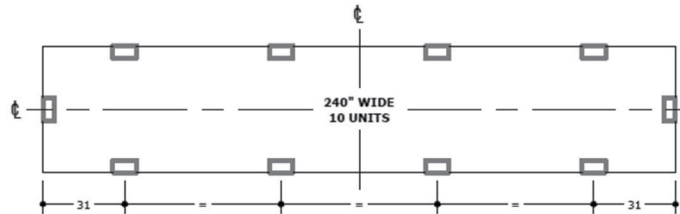

240" WIDE
10 UNITS

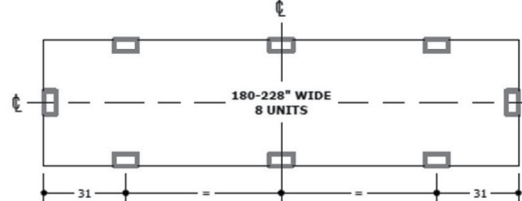

180-228" WIDE
8 UNITS

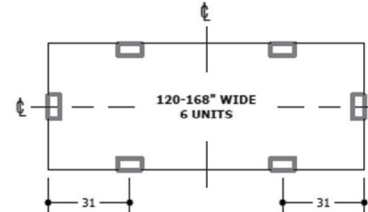

120-168" WIDE
6 UNITS

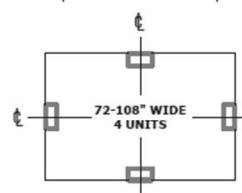

72-108" WIDE
4 UNITS

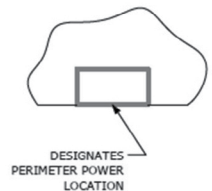

General Specifications

Highline Vector Conference Tables

Power & Connectivity / Base Details

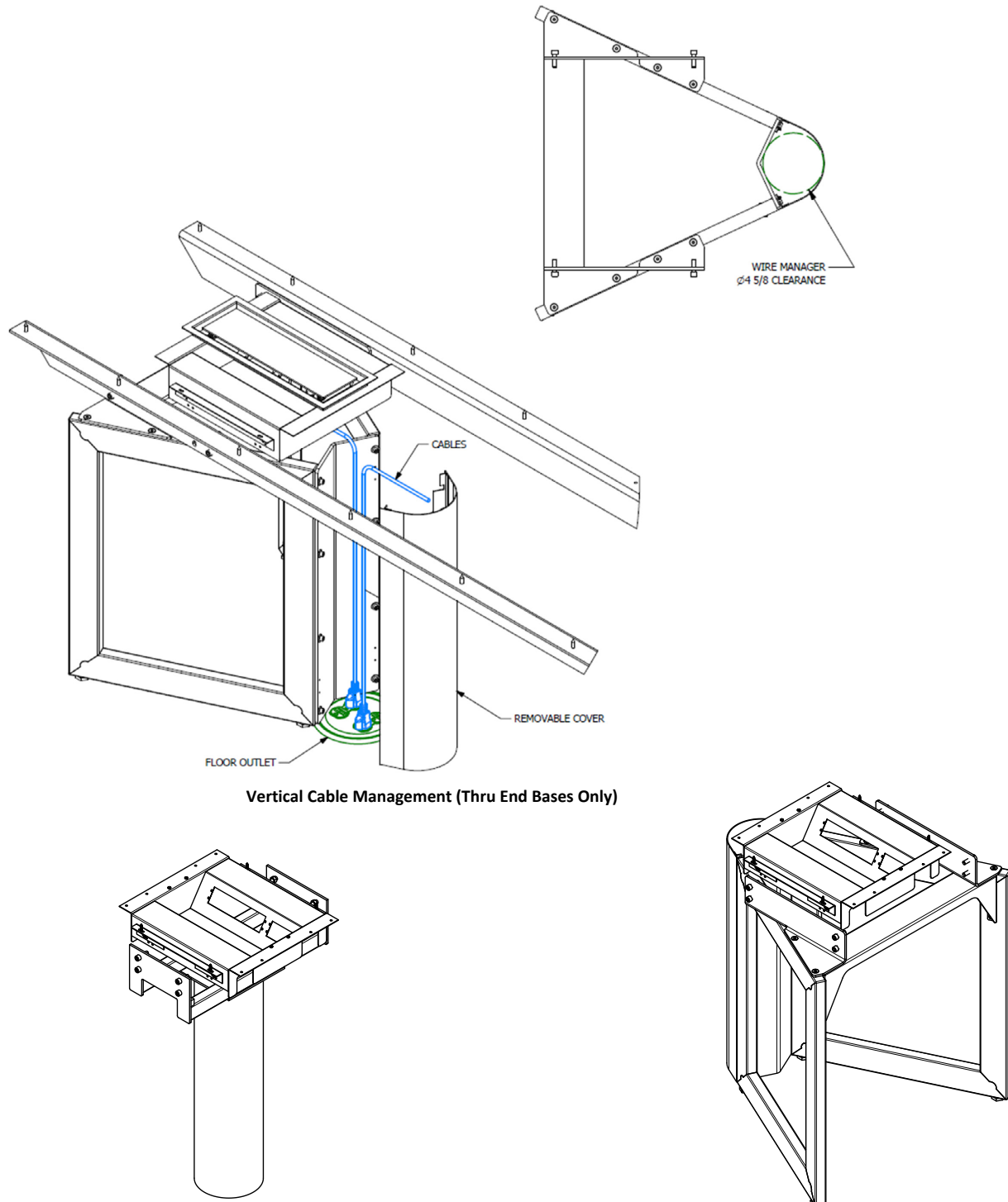

Vertical Cable Management (Thru End Bases Only)

General Specifications

Highline Vector Conference Tables

Edge Profile Details

Standard Edge Profiles

Flat Profile (F1)

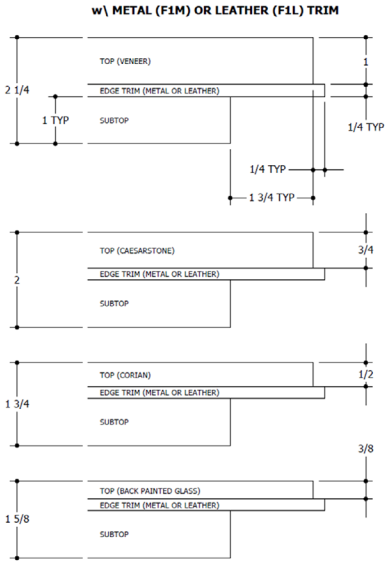

Slab Profile (SF)

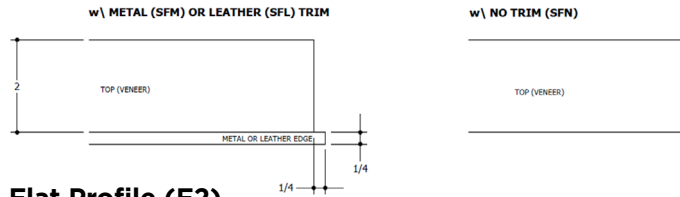

Flat Profile (F2)

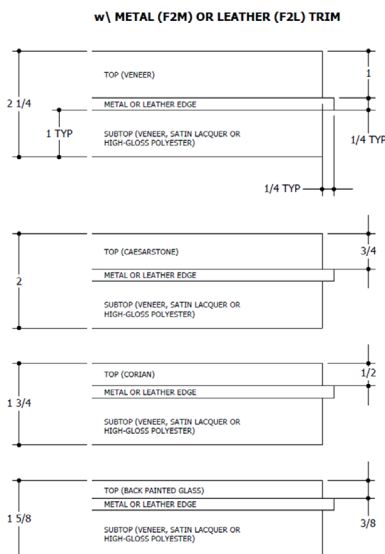

Upcharge Edge Profiles

Rounded Profile (R1)

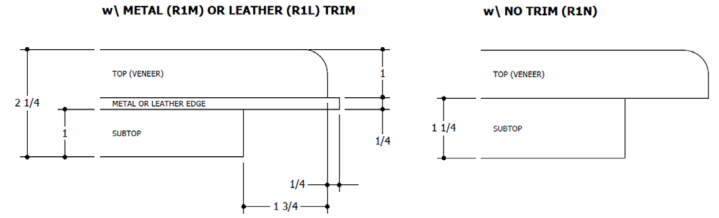

Bullnose Profile (B1)

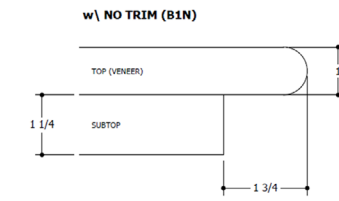

Rounded Profile (R2)

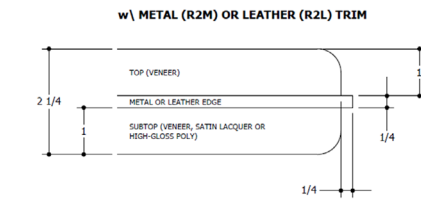

Tapered Profile (TP2)

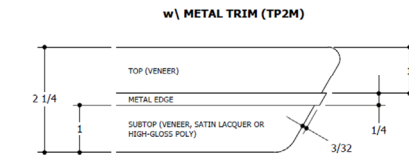

General Specifications

Highline Vector Conference Tables

Edge Profile Upcharges

D	W	1 Layer Edge Profile	2 Layer Edge Profile				
42"	84"	\$2,020	\$4,039	54"	120"	2,788	5,577
42"	96"	2,212	4,424	54"	132"	2,982	5,962
42"	108"	2,404	4,808	54"	144"	3,173	6,346
42"	120"	2,596	5,192	54"	156"	3,366	6,732
42"	132"	2,789	5,578	54"	168"	3,558	7,116
42"	144"	2,982	5,962	54"	180"	3,749	7,501
42"	156"	3,174	6,347	54"	192"	3,944	7,885
42"	168"	3,367	6,732	54"	204"	4,135	8,270
42"	180"	3,558	7,117	54"	216"	4,327	8,656
42"	192"	3,751	7,500	54"	228"	4,520	9,040
42"	204"	3,942	7,885	54"	240"	4,713	9,424
42"	216"	4,136	8,271	60"	120"	2,885	5,770
42"	228"	4,328	8,656	60"	132"	3,078	6,155
42"	240"	4,520	9,039	60"	144"	3,269	6,540
48"	84"	2,116	4,231	60"	156"	3,462	6,924
48"	96"	2,308	4,615	60"	168"	3,655	7,308
48"	108"	2,500	5,001	60"	180"	3,847	7,693
48"	120"	2,694	5,386	60"	192"	4,039	8,079
48"	132"	2,885	5,770	60"	204"	4,231	8,462
48"	144"	3,077	6,156	60"	216"	4,424	8,847
48"	156"	3,270	6,539	60"	228"	4,615	9,232
48"	168"	3,462	6,925	60"	240"	4,809	9,617
48"	180"	3,655	7,309	72"	144"	3,462	6,924
48"	192"	3,847	7,693	72"	156"	3,654	7,309
48"	204"	4,039	8,078	72"	168"	3,847	7,694
48"	216"	4,231	8,464	72"	180"	4,038	8,078
48"	228"	4,424	8,848	72"	192"	4,231	8,463
48"	240"	4,616	9,232	72"	204"	4,423	8,848
54"	84"	2,212	4,424	72"	216"	4,616	9,233
54"	96"	2,405	4,808	72"	228"	4,808	9,617
54"	108"	2,597	5,193	72"	240"	5,000	10,001

Highline Vector Conference Tables

42", 48" & 54" Deep Conference Tables

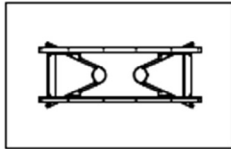
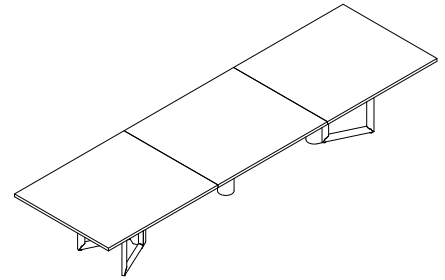

84L
SEATS 6

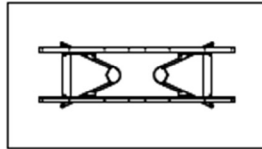

96L
SEATS 6-8

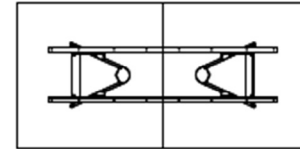

108L
SEATS 8

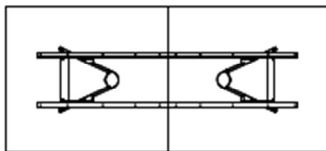

120L
SEATS 10

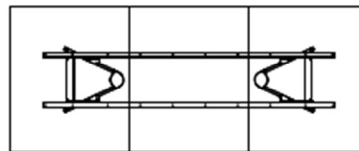

132L
SEATS 10

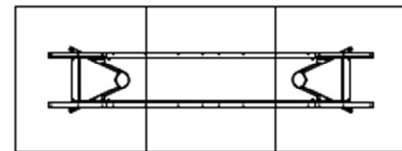

144L
SEATS 10



156L
SEATS 10-12

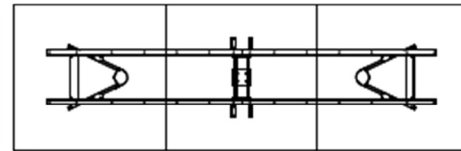

168L
SEATS 12

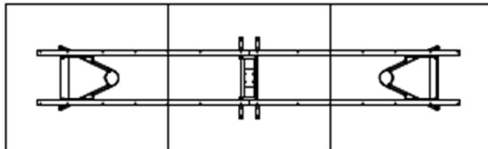

180L
SEATS 14

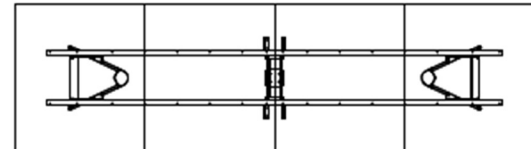

192L
SEATS 14

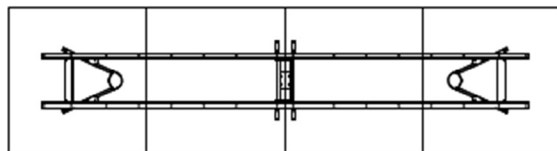

204L
SEATS 14

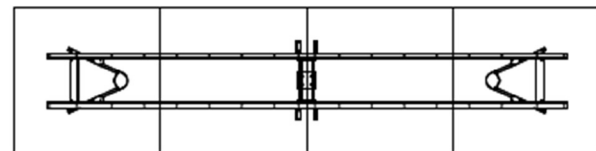

216L
SEATS 16

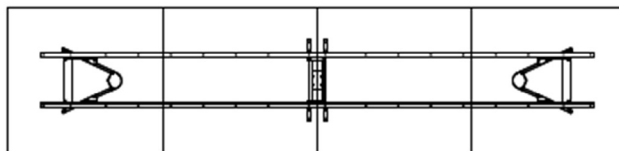

228L
SEATS 16

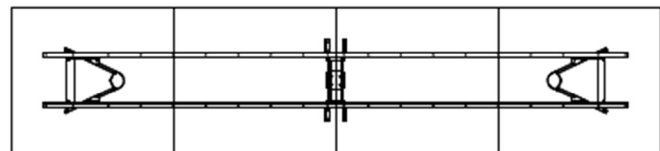

240L
SEATS 18

Highline Vector Conference Tables

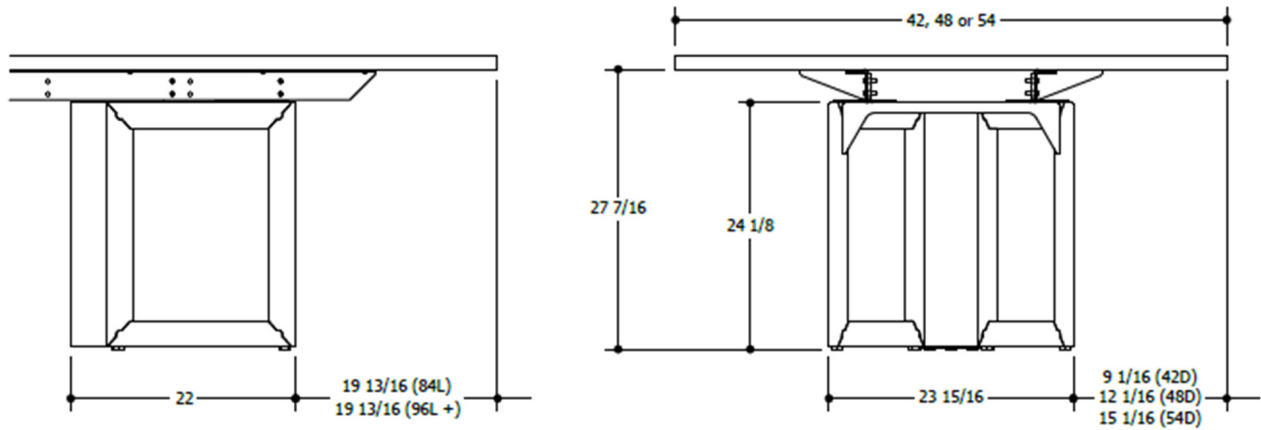
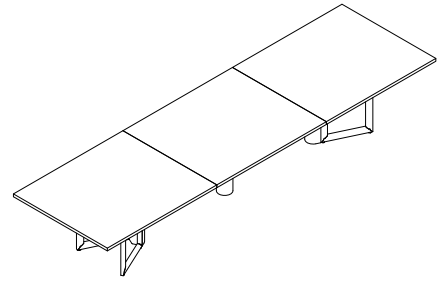

END BASE ELEVATION, 42, 48 & 54D

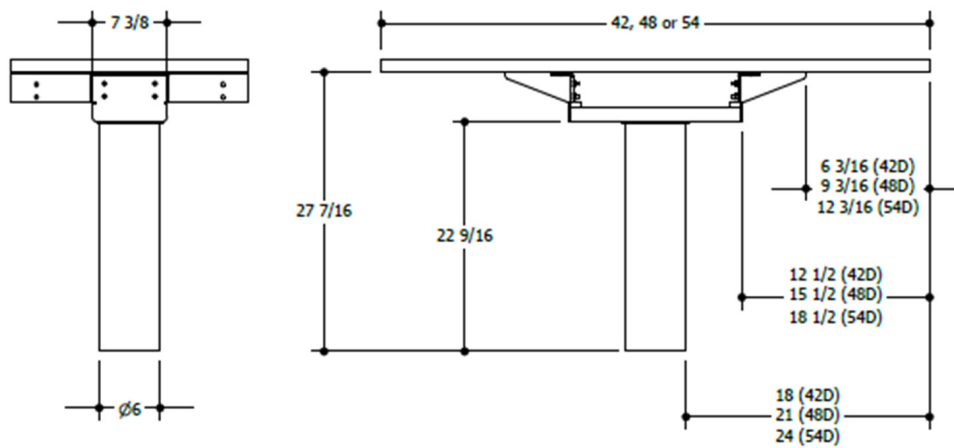

INTERMEDIATE COLUMN ELEVATIONS, 42, 48 & 54D

Rectangular Conference Tables

42" Deep Tops
1-Layer, Veneer Tops

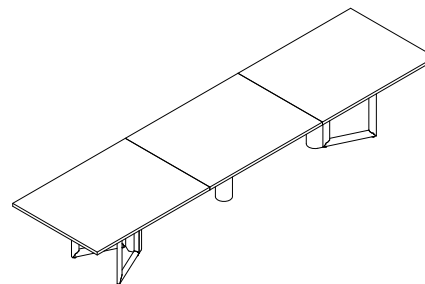

D	W	Pattern No.	T1__ Top	T2__ Top	MC__ Edge Upcharge	PM__ Edge Upcharge	AU__ Edge Upcharge	PM__ Base Upcharge
42"	84"	08VOFR4284VF1	\$13,602	\$14,233	\$2,245	\$2,774	\$4,097	\$2,181
42"	96"	08VOFR4296VF1	14,355	15,075	2,410	2,983	4,429	2,181
42"	108"	08VOFR42108VF1	15,108	15,919	2,575	3,191	4,764	2,181
42"	120"	08VOFR42120VF1	15,860	16,760	2,741	3,399	5,097	2,181
42"	132"	08VOFR42132VF1	16,613	17,603	2,906	3,637	5,431	2,181
42"	144"	08VOFR42144VF1	17,365	18,446	3,072	3,845	5,764	2,181
42"	156"	08VOFR42156VF1	18,119	19,290	3,235	4,052	6,097	2,181
42"	168"	08VOFR42168VF1	19,863	21,124	3,551	4,408	6,580	3,686
42"	180"	08VOFR42180VF1	20,482	21,819	3,548	4,449	6,746	3,686
42"	192"	08VOFR42192VF1	21,100	22,541	3,546	4,490	6,912	3,686
42"	204"	08VOFR42204VF1	21,719	23,250	3,544	4,531	7,079	3,686
42"	216"	08VOFR42216VF1	22,337	23,957	3,541	4,543	7,244	3,686
42"	228"	08VOFR42228VF1	22,955	24,666	3,540	4,614	7,440	3,686
42"	240"	08VOFR42240VF1	23,575	25,376	3,536	4,652	7,576	3,686

Order Code	Specification Information	Refer To Accessories Section	Pricing Tiers
Example: 08VOFR4284VF1M-T003-PM01-MC01-GM2-MC01-UCO	To order please specify pattern number including:	Please refer to Accessories section, page 211 for power details.	Please refer to Materials and Finish page 7 for specification details.
08 Highline Collection	1. Top finish	Grommet options available in these finishes:	T1 and T2 pricing includes powder coated base finish.
VOF Vector Base	2. Trim Finish (only applies if trim type is metal or leather)	Powder coated	There is an upcharge for plated base finishes as highlighted above.
R Rectangular	3. Base finish	Premium (Polished Chrome, Satin Nickel or Oil Rubbed Bronze)	For additional stone options and pricing please contact your sales representative."
42 Depth	4. Grommet option	Power Box Options	
84 Width	5. Grommet finish (only applies if grommets are selected)	Code: Description:	
V Veneer	6. Power box option	NP No Power	
F1 1 Layer-Flat w/ Trim	7. Table-top power finish (only applies if table-top power is selected)	UCO Undermount	
M Metal Trim		ECO Table Top Lid	
T003 Top Finish	Trim Type	TIE Tabletop 1-Sided Lid	
PM01 Trim Finish	N = No trim	T2C Tabletop 2-Sided Lid	
MC01 Base Finish	M = Metal (available in Premium and Powder Coat finishes)	Must select Wire Management Column and Finish:	
GM2 Grommet Opt.	L = Leather	Powder coated	
MC01 Grommet Finish		Premium (Polished Chrome, Satin Nickel or Oil Rubbed Bronze)	
UCO Undermount			

Rectangular Conference Tables

42" Deep Tops
2-Layer, Veneer Tops

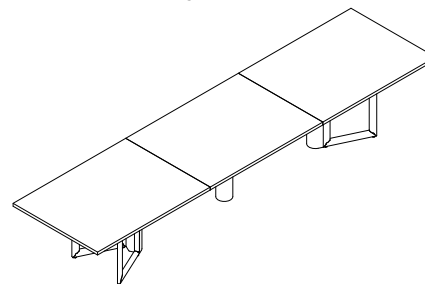

D	W	Pattern No.	T1__ Top	T2__ Top	T__ Lower Layer	HG__ Lower Layer	PM__ Edge Upcharge	AU__ Edge Upcharge	PM__ Base Upcharge
42"	84"	08VOFR4284VF2	\$17,502	\$18,133	\$465	\$509	\$529	\$1,852	\$2,181
42"	96"	08VOFR4296VF2	18,481	19,202	512	564	573	2,019	2,181
42"	108"	08VOFR42108VF2	19,461	20,271	567	623	616	2,189	2,181
42"	120"	08VOFR42120VF2	20,441	21,340	646	711	658	2,356	2,181
42"	132"	08VOFR42132VF2	21,420	22,411	691	759	731	2,525	2,181
42"	144"	08VOFR42144VF2	22,400	23,480	734	806	773	2,692	2,181
42"	156"	08VOFR42156VF2	23,379	24,550	739	813	817	2,862	2,181
42"	168"	08VOFR42168VF2	25,905	27,166	814	897	857	3,029	3,686
42"	180"	08VOFR42180VF2	26,548	27,885	900	990	901	3,198	3,686
42"	192"	08VOFR42192VF2	27,192	28,631	921	1,014	944	3,366	3,686
42"	204"	08VOFR42204VF2	27,835	29,365	970	1,068	987	3,535	3,686
42"	216"	08VOFR42216VF2	28,477	30,098	1,026	1,127	1,002	3,703	3,686
42"	228"	08VOFR42228VF2	29,120	30,832	1,078	1,186	1,074	3,900	3,686
42"	240"	08VOFR42240VF2	29,765	31,564	1,160	1,276	1,116	4,040	3,686

Order Code	Specification Information	Refer To Accessories Section	Pricing Tiers
Example: 08VOFR4284VF2M-T003-PM01-MC01-GM2-MC01-UCO	To order please specify pattern number including:	Please refer to Accessories section, page 211 for power details.	Please refer to Materials and Finish page 7 for specification details.
08 Highline Collection	1. Top finish	Grommet options available in these finishes:	T1 and T2 pricing includes powder coated base finish.
VOF Vector Base	2. Trim Finish (only applies if trim type is metal or leather)	Powder coated	There is an upcharge for plated base finishes as highlighted above.
R Rectangular	3. Base finish	Premium (Polished Chrome, Satin Nickel or Oil Rubbed Bronze)	For additional stone options and pricing please contact your sales representative."
42 Depth	4. Grommet option	Power Box Options	
84 Width	5. Grommet finish (only applies if grommets are selected)	Code: Description:	
V Veneer	6. Power box option	NP No Power	
F2 2 Layer-Flat w/ Trim	7. Table-top power finish (only applies if table-top power is selected)	UCO Undermount	
M Metal Trim		ECO Table Top Lid	
T003 Top Finish	Trim Type	TIE Tabletop 1-Sided Lid	
PM01 Trim Finish	N = No trim	T2C Tabletop 2-Sided Lid	
MC01 Base Finish	M = Metal (available in Premium and Powder Coat finishes)	Must select Wire Management Column and Finish:	
GM2 Grommet Opt.	L = Leather	Powder coated	
MC01 Grommet Finish		Premium (Polished Chrome, Satin Nickel or Oil Rubbed Bronze)	
UCO Undermount			

Rectangular Conference Tables

42" Deep Tops
Slab Top, Veneer Tops

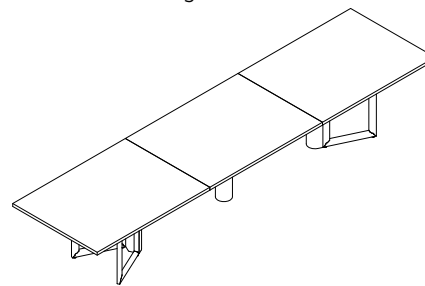

D	W	Pattern No.	T1__ Top	T2__ Top	MC__ Edge Upcharge	PM__ Edge Upcharge	AU__ Edge Upcharge	PM__ Base Upcharge
42"	84"	08VOFR4284VSF	\$15,257	\$15,888	\$2,245	\$2,774	\$4,097	\$2,181
42"	96"	08VOFR4296VSF	16,072	16,792	2,409	2,982	4,428	2,181
42"	108"	08VOFR42108VSF	16,886	17,696	2,575	3,191	4,764	2,181
42"	120"	08VOFR42120VSF	17,699	18,600	2,742	3,400	5,098	2,181
42"	132"	08VOFR42132VSF	18,514	19,504	2,906	3,637	5,431	2,181
42"	144"	08VOFR42144VSF	19,328	20,409	3,072	3,845	5,764	2,181
42"	156"	08VOFR42156VSF	20,144	21,315	3,235	4,052	6,097	2,181
42"	168"	08VOFR42168VSF	22,355	23,615	3,550	4,407	6,579	3,686
42"	180"	08VOFR42180VSF	23,000	24,336	3,548	4,449	6,746	3,686
42"	192"	08VOFR42192VSF	23,645	25,086	3,547	4,491	6,913	3,686
42"	204"	08VOFR42204VSF	24,291	25,822	3,544	4,531	7,079	3,686
42"	216"	08VOFR42216VSF	24,936	26,556	3,541	4,543	7,244	3,686
42"	228"	08VOFR42228VSF	25,581	27,292	3,539	4,613	7,439	3,686
42"	240"	08VOFR42240VSF	26,229	28,029	3,536	4,652	7,576	3,686

Order Code	Specification Information	Refer To Accessories Section	Pricing Tiers
Example: 08VOFR4284VSFM-T003-PM01-MC01-GM2-MC01-UCO	To order please specify pattern number including:	Please refer to Accessories section, page 211 for power details.	Please refer to Materials and Finish page 7 for specification details.
08 Highline Collection	1. Top finish	Grommet options available in these finishes:	T1 and T2 pricing includes powder coated base finish.
VOF Vector Base	2. Trim Finish (only applies if trim type is metal or leather)	Powder coated	There is an upcharge for plated base finishes as highlighted above.
R Rectangular	3. Base finish	Premium (Polished Chrome, Satin Nickel or Oil Rubbed Bronze)	For additional stone options and pricing please contact your sales representative."
42 Depth	4. Grommet option	Power Box Options	
84 Width	5. Grommet finish (only applies if grommets are selected)	Code: Description:	
VS Veneer	6. Power box option	NP No Power	
SF Slab	7. Table-top power finish (only applies if table-top power is selected)	UCO Undermount	
M Metal Trim		ECO Table Top Lid	
T003 Top Finish	Trim Type	T1E Tabletop 1-Sided Lid	
PM01 Trim Finish	N = No trim	T2C Tabletop 2-Sided Lid	
MC01 Base Finish	M = Metal (available in Premium and Powder Coat finishes)	Must select Wire Management Column and Finish:	
GM2 Grommet Opt.	L = Leather	Powder coated	
MC01 Grommet Finish		Premium (Polished Chrome, Satin Nickel or Oil Rubbed Bronze)	
UCO Undermount			

Rectangular Conference Tables

42" Deep Tops
1-Layer, Glass Tops

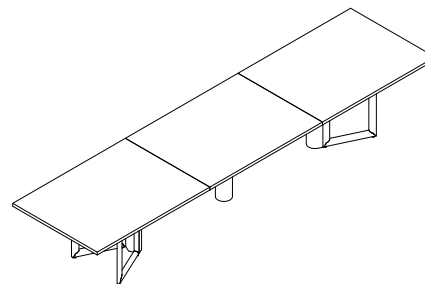

D	W	Pattern No.	GC__ Top	GE__ Top	PM__ Edge Upcharge	AU__ Edge Upcharge	PM__ Base Upcharge
42"	84"	08VOFR4284GF1	\$19,344	\$19,915	\$529	\$1,852	\$2,181
42"	96"	08VOFR4296GF1	20,704	21,358	573	2,019	2,181
42"	108"	08VOFR42108GF1	22,066	22,799	616	2,189	2,181
42"	120"	08VOFR42120GF1	23,425	24,241	658	2,356	2,181
42"	132"	08VOFR42132GF1	24,786	25,684	731	2,525	2,181
42"	144"	08VOFR42144GF1	26,147	27,126	773	2,692	2,181
42"	156"	08VOFR42156GF1	27,507	28,568	817	2,862	2,181
42"	168"	08VOFR42168GF1	30,057	31,199	857	3,029	3,686
42"	180"	08VOFR42180GF1	31,103	32,328	901	3,198	3,686
42"	192"	08VOFR42192GF1	32,149	33,454	944	3,366	3,686
42"	204"	08VOFR42204GF1	33,196	34,583	987	3,535	3,686
42"	216"	08VOFR42216GF1	34,241	35,710	1,002	3,703	3,686
42"	228"	08VOFR42228GF1	35,288	36,838	1,074	3,900	3,686
42"	240"	08VOFR42240GF1	36,334	37,965	1,116	4,040	3,686

Order Code	Specification Information	Refer To Accessories Section	Pricing Tiers
Example: 08VOFR4284GF1M-GE01-PM01-MC01-GM2-MC01-UC0	To order please specify pattern number including:	Please refer to Accessories section, page 211 for power details.	Please refer to Materials and Finish page 7 for specification details.
08 Highline Collection	1. Top finish	Grommet options available in these finishes:	T1 and T2 pricing includes powder coated base finish.
VOF Vector Base	2. Trim Finish (only applies if trim type is metal or leather)	Powder coated	There is an upcharge for plated base finishes as highlighted above.
R Rectangular	3. Base finish	Premium (Polished Chrome, Satin Nickel or Oil Rubbed Bronze)	For additional stone options and pricing please contact your sales representative."
42 Depth	4. Grommet option	Power Box Options	
84 Width	5. Grommet finish (only applies if grommets are selected)	Code: Description:	
G Glass	6. Power box option	NP No Power	
F1 1 Layer-Flat w/ Trim	7. Table-top power finish (only applies if table-top power is selected)	UCO Undermount	
M Metal Trim		ECO Table Top Lid	
GE01 Top Finish	Trim Type	T1E Tabletop 1-Sided Lid	
PM01 Trim Finish	N = No trim	T2C Tabletop 2-Sided Lid	
MC01 Base Finish	M = Metal (available in Premium and Powder Coat finishes)	Must select Wire Management Column and Finish:	
GM2 Grommet Opt.	L = Leather	Powder coated	
MC01 Grommet Finish		Premium (Polished Chrome, Satin Nickel or Oil Rubbed Bronze)	
UC0 Undermount			

Rectangular Conference Tables

42" Deep Tops
2-Layer, Glass Tops

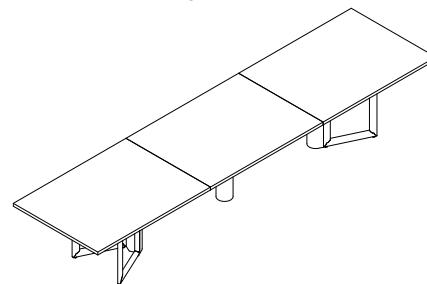

D	W	Pattern No.	GC__ Top	GE__ Top	T__ Lower Layer	HG__ Lower Layer	PM__ Edge Upcharge	AU__ Edge Upcharge	PM__ Base Upcharge
42"	84"	08VOFR4284GF2	\$21,069	\$21,639	\$465	\$509	\$529	\$1,852	\$2,181
42"	96"	08VOFR4296GF2	22,493	23,147	512	564	573	2,019	2,181
42"	108"	08VOFR42108GF2	23,918	24,653	567	623	616	2,189	2,181
42"	120"	08VOFR42120GF2	25,342	26,158	646	711	658	2,356	2,181
42"	132"	08VOFR42132GF2	26,768	27,666	691	759	731	2,525	2,181
42"	144"	08VOFR42144GF2	28,192	29,171	734	806	773	2,692	2,181
42"	156"	08VOFR42156GF2	29,618	30,678	739	813	817	2,862	2,181
42"	168"	08VOFR42168GF2	32,654	33,796	814	897	857	3,029	3,686
42"	180"	08VOFR42180GF2	33,728	34,952	900	990	901	3,198	3,686
42"	192"	08VOFR42192GF2	34,802	36,107	921	1,014	944	3,366	3,686
42"	204"	08VOFR42204GF2	35,876	37,264	970	1,068	987	3,535	3,686
42"	216"	08VOFR42216GF2	36,950	38,418	1,026	1,127	1,002	3,703	3,686
42"	228"	08VOFR42228GF2	38,024	39,575	1,078	1,186	1,074	3,900	3,686
42"	240"	08VOFR42240GF2	39,099	40,730	1,160	1,276	1,116	4,040	3,686

Order Code	Specification Information	Refer To Accessories Section	Pricing Tiers
Example: 08VOFR4284GF2M-GE01-PM01-MC01-GM2-MC01-UCO	To order please specify pattern number including:	Please refer to Accessories section, page 211 for power details.	Please refer to Materials and Finish page 7 for specification details.
08 Highline Collection	1. Top finish	Grommet options available in these finishes:	T1 and T2 pricing includes powder coated base finish.
VOF Vector Base	2. Trim Finish (only applies if trim type is metal or leather)	Powder coated	There is an upcharge for plated base finishes as highlighted above.
R Rectangular	3. Base finish	Premium (Polished Chrome, Satin Nickel or Oil Rubbed Bronze)	For additional stone options and pricing please contact your sales representative."
42 Depth	4. Grommet option	Power Box Options	
84 Width	5. Grommet finish (only applies if grommets are selected)	Code: Description:	
G Glass	6. Power box option	NP No Power	
F2 2 Layer-Flat w/ Trim	7. Table-top power finish (only applies if table-top power is selected)	UCO Undermount	
M Metal Trim		ECO Table Top Lid	
GE01 Top Finish	Trim Type	TIE Tabletop 1-Sided Lid	
PM01 Trim Finish	N = No trim	T2C Tabletop 2-Sided Lid	
MC01 Base Finish	M = Metal (available in Premium and Powder Coat finishes)	Must select Wire Management Column and Finish:	
GM2 Grommet Opt.	L = Leather	Powder coated	
MC01 Grommet Finish		Premium (Polished Chrome, Satin Nickel or Oil Rubbed Bronze)	
UCO Undermount			

Rectangular Conference Tables

42" Deep Tops
1-Layer, Corian Tops

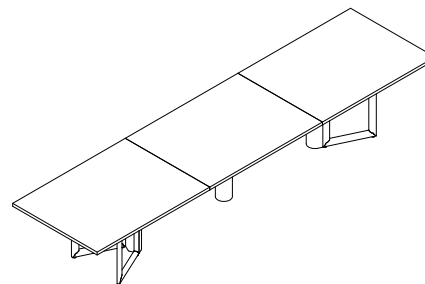

D	W	Pattern No.	CS01 Top	MC__ Edge Upcharge	PM__ Edge Upcharge	AU__ Edge Upcharge	PM__ Base Upcharge
42"	84"	08VOFR4284CF1	\$17,576	\$2,244	\$2,773	\$4,096	\$2,181
42"	96"	08VOFR4296CF1	18,895	2,410	2,983	4,429	2,181
42"	108"	08VOFR42108CF1	20,196	2,575	3,191	4,764	2,181
42"	120"	08VOFR42120CF1	21,535	2,741	3,399	5,097	2,181
42"	132"	08VOFR42132CF1	22,856	2,906	3,637	5,431	2,181
42"	144"	08VOFR42144CF1	24,176	3,071	3,844	5,763	2,181
42"	156"	08VOFR42156CF1	25,497	3,236	4,053	6,098	2,181
42"	168"	08VOFR42168CF1	27,808	3,551	4,408	6,580	3,686
42"	180"	08VOFR42180CF1	28,995	3,548	4,449	6,746	3,686
42"	192"	08VOFR42192CF1	30,180	3,546	4,490	6,912	3,686
42"	204"	08VOFR42204CF1	31,367	3,544	4,531	7,079	3,686
42"	216"	08VOFR42216CF1	32,553	3,541	4,543	7,244	3,686
42"	228"	08VOFR42228CF1	33,739	3,539	4,613	7,439	3,686
42"	240"	08VOFR42240CF1	34,926	3,535	4,651	7,575	3,686

Order Code	Specification Information	Refer To Accessories Section	Pricing Tiers
Example: 08VOFR4284CF1M-CS01-PM01-MC01-GM2-MC01-UCO	To order please specify pattern number including:	Please refer to Accessories section, page 211 for power details.	Please refer to Materials and Finish page 7 for specification details.
08 Highline Collection	1. Top finish	Grommet options available in these finishes:	T1 and T2 pricing includes powder coated base finish.
VOF Vector Base	2. Trim Finish (only applies if trim type is metal or leather)	Powder coated	There is an upcharge for plated base finishes as highlighted above.
R Rectangular	3. Base finish	Premium (Polished Chrome, Satin Nickel or Oil Rubbed Bronze)	For additional stone options and pricing please contact your sales representative."
42 Depth	4. Grommet option	Power Box Options	
84 Width	5. Grommet finish (only applies if grommets are selected)	Code: Description:	
C Corian	6. Power box option	NP No Power	
F1 1 Layer-Flat w/ Trim	7. Table-top power finish (only applies if table-top power is selected)	UCO Undermount	
M Metal Trim		ECO Table Top Lid	
CS01 Top Finish	Trim Type	T1E Tabletop 1-Sided Lid	
PM01 Trim Finish	N = No trim	T2C Tabletop 2-Sided Lid	
MC01 Base Finish	M = Metal (available in Premium and Powder Coat finishes)	Must select Wire Management Column and Finish:	
GM2 Grommet Opt.	L = Leather	Powder coated	
MC01 Grommet Finish		Premium (Polished Chrome, Satin Nickel or Oil Rubbed Bronze)	
UCO Undermount			

Rectangular Conference Tables

42" Deep Tops 2-Layer, Corian Tops

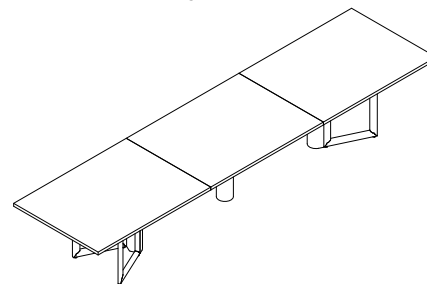

D	W	Pattern No.	CS01 Top	T___ Lower Layer	HG___ Lower Layer	PM___ Edge Upcharge	AU___ Edge Upcharge	PM___ Base Upcharge
42"	84"	08VOFR4284CF2	\$21,475	\$465	\$509	\$529	\$1,852	\$2,181
42"	96"	08VOFR4296CF2	23,021	512	564	573	2,019	2,181
42"	108"	08VOFR42108CF2	24,549	567	623	616	2,189	2,181
42"	120"	08VOFR42120CF2	26,116	646	711	658	2,356	2,181
42"	132"	08VOFR42132CF2	27,663	691	759	731	2,525	2,181
42"	144"	08VOFR42144CF2	29,210	734	806	773	2,692	2,181
42"	156"	08VOFR42156CF2	30,757	739	813	817	2,862	2,181
42"	168"	08VOFR42168CF2	33,851	814	897	857	3,029	3,686
42"	180"	08VOFR42180CF2	35,062	900	990	901	3,198	3,686
42"	192"	08VOFR42192CF2	36,272	921	1,014	944	3,366	3,686
42"	204"	08VOFR42204CF2	37,483	970	1,068	987	3,535	3,686
42"	216"	08VOFR42216CF2	38,693	1,026	1,127	1,002	3,703	3,686
42"	228"	08VOFR42228CF2	39,903	1,078	1,186	1,074	3,900	3,686
42"	240"	08VOFR42240CF2	41,114	1,160	1,276	1,116	4,040	3,686

Order Code	Specification Information	Refer To Accessories Section	Pricing Tiers
Example: 08VOFR4284CF2M-CS01-PM01-MC01-GM2-MC01-UCO	To order please specify pattern number including:	Please refer to Accessories section, page 211 for power details.	Please refer to Materials and Finish page 7 for specification details.
08 Highline Collection	1. Top finish	Grommet options available in these finishes:	T1 and T2 pricing includes powder coated base finish.
VOF Vector Base	2. Trim Finish (only applies if trim type is metal or leather)	Powder coated	There is an upcharge for plated base finishes as highlighted above.
R Rectangular	3. Base finish	Premium (Polished Chrome, Satin Nickel or Oil Rubbed Bronze)	For additional stone options and pricing please contact your sales representative."
42 Depth	4. Grommet option	Power Box Options	
84 Width	5. Grommet finish (only applies if grommets are selected)	Code: Description:	
C Corian	6. Power box option	NP No Power	
F2 2 Layer-Flat w/ Trim	7. Table-top power finish (only applies if table-top power is selected)	UCO Undermount	
M Metal Trim		ECO Table Top Lid	
CS01 Top Finish	Trim Type	T1E Tabletop 1-Sided Lid	
PM01 Trim Finish	N = No trim	T2C Tabletop 2-Sided Lid	
MC01 Base Finish	M = Metal (available in Premium and Powder Coat finishes)	Must select Wire Management Column and Finish:	
GM2 Grommet Opt.	L = Leather	Powder coated	
MC01 Grommet Finish		Premium (Polished Chrome, Satin Nickel or Oil Rubbed Bronze)	
UCO Undermount			

Rectangular Conference Tables

48" Deep Tops
1-Layer, Veneer Tops

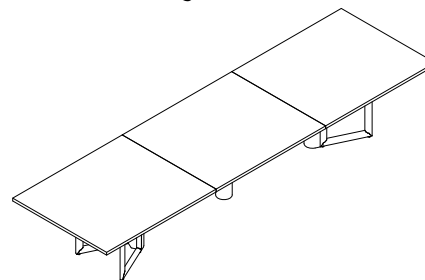

D	W	Pattern No.	T1__ Top	T2__ Top	MC__ Edge Upcharge	PM__ Edge Upcharge	AU__ Edge Upcharge	PM__ Base Upcharge
48"	84"	08VOFR4884VF1	\$14,200	\$14,920	\$2,292	\$2,897	\$4,408	\$2,181
48"	96"	08VOFR4896VF1	15,044	15,866	2,464	3,118	4,772	2,181
48"	108"	08VOFR48108VF1	15,888	16,814	2,634	3,337	5,135	2,181
48"	120"	08VOFR48120VF1	16,732	17,761	2,806	3,559	5,498	2,181
48"	132"	08VOFR48132VF1	17,577	18,709	2,976	3,810	5,861	2,181
48"	144"	08VOFR48144VF1	18,421	19,656	3,147	4,031	6,225	2,181
48"	156"	08VOFR48156VF1	19,266	20,603	3,318	4,251	6,588	2,181
48"	168"	08VOFR48168VF1	21,121	22,562	3,583	4,564	7,045	3,686
48"	180"	08VOFR48180VF1	21,833	23,343	3,578	4,608	7,232	3,686
48"	192"	08VOFR48192VF1	22,544	24,190	3,575	4,654	7,422	3,686
48"	204"	08VOFR48204VF1	23,255	25,004	3,572	4,700	7,612	3,686
48"	216"	08VOFR48216VF1	23,967	25,818	3,568	4,713	7,799	3,686
48"	228"	08VOFR48228VF1	24,677	26,632	3,566	4,793	8,023	3,686
48"	240"	08VOFR48240VF1	25,385	27,443	3,567	4,843	8,183	3,686

Order Code	Specification Information	Refer To Accessories Section	Pricing Tiers
Example: 08VOFR4884VF1M-T003-PM01-MC01-GM2-MC01-UC0	To order please specify pattern number including:	Please refer to Accessories section, page 211 for power details.	Please refer to Materials and Finish page 7 for specification details.
08 Highline Collection	1. Top finish	Grommet options available in these finishes:	T1 and T2 pricing includes powder coated base finish.
VOF Vector Base	2. Trim Finish (only applies if trim type is metal or leather)	Powder coated	There is an upcharge for plated base finishes as highlighted above.
R Rectangular	3. Base finish	Premium (Polished Chrome, Satin Nickel or Oil Rubbed Bronze)	For additional stone options and pricing please contact your sales representative."
48 Depth	4. Grommet option	Power Box Options	
84 Width	5. Grommet finish (only applies if grommets are selected)	Code: Description:	
V Veneer	6. Power box option	NP No Power	
F1 1 Layer-Flat w/ Trim	7. Table-top power finish (only applies if table-top power is selected)	UCO Undermount	
M Metal Trim		ECO Table Top Lid	
T003 Top Finish	Trim Type	TIE Tabletop 1-Sided Lid	
PM01 Trim Finish	N = No trim	T2C Tabletop 2-Sided Lid	
MC01 Base Finish	M = Metal (available in Premium and Powder Coat finishes)	Must select Wire Management Column and Finish:	
GM2 Grommet Opt.	L = Leather	Powder coated	
MC01 Grommet Finish		Premium (Polished Chrome, Satin Nickel or Oil Rubbed Bronze)	
UC0 Undermount			

Rectangular Conference Tables

48" Deep Tops
2-Layer, Veneer Tops

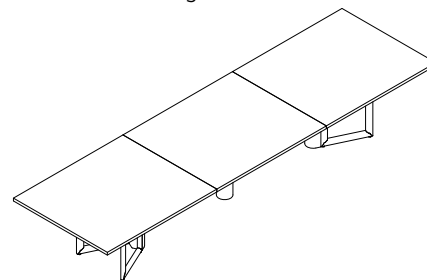

D	W	Pattern No.	T1__ Top	T2__ Top	T__ Lower Layer	HG__ Lower Layer	PM__ Edge Upcharge	AU__ Edge Upcharge	PM__ Base Upcharge
48"	84"	08VOFR4884VF2	\$18,610	\$19,330	\$531	\$581	\$605	\$2,116	\$2,181
48"	96"	08VOFR4896VF2	19,493	20,315	585	645	654	2,308	2,181
48"	108"	08VOFR48108VF2	20,375	21,300	648	712	703	2,501	2,181
48"	120"	08VOFR48120VF2	21,256	22,285	739	813	753	2,692	2,181
48"	132"	08VOFR48132VF2	22,139	23,271	789	868	834	2,885	2,181
48"	144"	08VOFR48144VF2	23,021	24,256	839	921	884	3,078	2,181
48"	156"	08VOFR48156VF2	23,904	25,242	845	930	933	3,270	2,181
48"	168"	08VOFR48168VF2	26,907	28,348	931	1,025	981	3,462	3,686
48"	180"	08VOFR48180VF2	27,624	29,134	1,029	1,132	1,030	3,654	3,686
48"	192"	08VOFR48192VF2	28,341	29,987	1,053	1,160	1,079	3,847	3,686
48"	204"	08VOFR48204VF2	29,057	30,806	1,110	1,220	1,128	4,040	3,686
48"	216"	08VOFR48216VF2	29,774	31,626	1,172	1,289	1,145	4,231	3,686
48"	228"	08VOFR48228VF2	30,491	32,446	1,232	1,356	1,227	4,457	3,686
48"	240"	08VOFR48240VF2	31,208	33,265	1,325	1,458	1,276	4,616	3,686

Order Code	Specification Information	Refer To Accessories Section	Pricing Tiers
Example: 08VOFR4884VF2M-T003-PM01-MC01-GM2-MC01-UC0	To order please specify pattern number including:	Please refer to Accessories section, page 211 for power details.	Please refer to Materials and Finish page 7 for specification details.
08 Highline Collection	1. Top finish	Grommet options available in these finishes:	T1 and T2 pricing includes powder coated base finish.
VOF Vector Base	2. Trim Finish (only applies if trim type is metal or leather)	Powder coated	There is an upcharge for plated base finishes as highlighted above.
R Rectangular	3. Base finish	Premium (Polished Chrome, Satin Nickel or Oil Rubbed Bronze)	For additional stone options and pricing please contact your sales representative."
48 Depth	4. Grommet option	Power Box Options	
84 Width	5. Grommet finish (only applies if grommets are selected)	Code: Description:	
V Veneer	6. Power box option	NP No Power	
F2 2 Layer-Flat w/ Trim	7. Table-top power finish (only applies if table-top power is selected)	UCO Undermount	
M Metal Trim		ECO Table Top Lid	
T003 Top Finish	Trim Type	T1E Tabletop 1-Sided Lid	
PM01 Trim Finish	N = No trim	T2C Tabletop 2-Sided Lid	
MC01 Base Finish	M = Metal (available in Premium and Powder Coat finishes)	Must select Wire Management Column and Finish:	
GM2 Grommet Opt.	L = Leather	Powder coated	
MC01 Grommet Finish		Premium (Polished Chrome, Satin Nickel or Oil Rubbed Bronze)	
UC0 Undermount			

Rectangular Conference Tables

48" Deep Tops Slab Top Veneer Tops

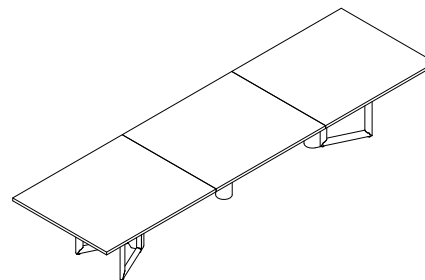

D	W	Pattern No.	T1__ Top	T2__ Top	MC__ Edge Upcharge	PM__ Edge Upcharge	AU__ Edge Upcharge	PM__ Base Upcharge
48"	84"	08VOFR4884VSF	\$16,318	\$17,038	\$2,292	\$2,897	\$4,408	\$2,181
48"	96"	08VOFR4896VSF	17,028	17,852	2,465	3,119	4,773	2,181
48"	108"	08VOFR48108VSF	17,740	18,666	2,635	3,338	5,136	2,181
48"	120"	08VOFR48120VSF	18,451	19,480	2,805	3,558	5,497	2,181
48"	132"	08VOFR48132VSF	19,163	20,294	2,976	3,810	5,861	2,181
48"	144"	08VOFR48144VSF	19,874	21,108	3,147	4,031	6,225	2,181
48"	156"	08VOFR48156VSF	20,585	21,923	3,319	4,252	6,589	2,181
48"	168"	08VOFR48168VSF	23,326	24,766	3,581	4,562	7,043	3,686
48"	180"	08VOFR48180VSF	24,046	25,556	3,578	4,608	7,232	3,686
48"	192"	08VOFR48192VSF	24,766	26,412	3,575	4,654	7,422	3,686
48"	204"	08VOFR48204VSF	25,487	27,235	3,570	4,698	7,610	3,686
48"	216"	08VOFR48216VSF	26,206	28,058	3,568	4,713	7,799	3,686
48"	228"	08VOFR48228VSF	26,926	28,881	3,565	4,792	8,022	3,686
48"	240"	08VOFR48240VSF	27,642	29,700	3,566	4,842	8,182	3,686

Order Code	Specification Information	Refer To Accessories Section	Pricing Tiers
Example: 08VOFR4884VSFM-T003-PM01-MC01-GM2-MC01-UCO	To order please specify pattern number including:	Please refer to Accessories section, page 211 for power details.	Please refer to Materials and Finish page 7 for specification details.
08 Highline Collection	1. Top finish	Grommet options available in these finishes:	T1 and T2 pricing includes powder coated base finish.
VOF Vector Base	2. Trim Finish (only applies if trim type is metal or leather)	Powder coated	There is an upcharge for plated base finishes as highlighted above.
R Rectangular	3. Base finish	Premium (Polished Chrome, Satin Nickel or Oil Rubbed Bronze)	For additional stone options and pricing please contact your sales representative."
48 Depth	4. Grommet option	Power Box Options	
84 Width	5. Grommet finish (only applies if grommets are selected)	Code: Description:	
V Veneer	6. Power box option	NP No Power	
SF Slab	7. Table-top power finish (only applies if table-top power is selected)	UCO Undermount	
M Metal Trim		ECO Table Top Lid	
T003 Top Finish	Trim Type	T1E Tabletop 1-Sided Lid	
PM01 Trim Finish	N = No trim	T2C Tabletop 2-Sided Lid	
MC01 Base Finish	M = Metal (available in Premium and Powder Coat finishes)	Must select Wire Management Column and Finish:	
GM2 Grommet Opt.	L = Leather	Powder coated	
MC01 Grommet Finish		Premium (Polished Chrome, Satin Nickel or Oil Rubbed Bronze)	
UCO Undermount			

Rectangular Conference Tables

48" Deep Tops
1-Layer, Glass Tops

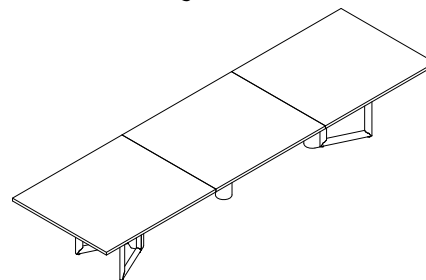

D	W	Pattern No.	GC__ Top	GE__ Top	PM__ Edge Upcharge	AU__ Edge Upcharge	PM__ Base Upcharge
48"	84"	08VOFR4884GF1	\$20,420	\$21,072	\$605	\$2,116	\$2,181
48"	96"	08VOFR4896GF1	21,939	22,686	654	2,308	2,181
48"	108"	08VOFR48108GF1	23,459	24,298	703	2,501	2,181
48"	120"	08VOFR48120GF1	24,979	25,912	753	2,692	2,181
48"	132"	08VOFR48132GF1	26,499	27,525	834	2,885	2,181
48"	144"	08VOFR48144GF1	28,019	29,138	884	3,078	2,181
48"	156"	08VOFR48156GF1	29,538	30,750	933	3,270	2,181
48"	168"	08VOFR48168GF1	32,209	33,514	981	3,462	3,686
48"	180"	08VOFR48180GF1	33,408	34,806	1,030	3,654	3,686
48"	192"	08VOFR48192GF1	34,608	36,099	1,079	3,847	3,686
48"	204"	08VOFR48204GF1	35,806	37,391	1,128	4,040	3,686
48"	216"	08VOFR48216GF1	37,006	38,685	1,145	4,231	3,686
48"	228"	08VOFR48228GF1	38,205	39,977	1,227	4,457	3,686
48"	240"	08VOFR48240GF1	39,406	41,271	1,276	4,616	3,686

Order Code	Specification Information	Refer To Accessories Section	Pricing Tiers
Example: 08VOFR4884GF1M-GE01-PM01-MC01-GM2-MC01-UCO	To order please specify pattern number including:	Please refer to Accessories section, page 211 for power details.	Please refer to Materials and Finish page 7 for specification details.
08 Highline Collection	1. Top finish	Grommet options available in these finishes:	T1 and T2 pricing includes powder coated base finish.
VOF Vector Base	2. Trim Finish (only applies if trim type is metal or leather)	Powder coated	There is an upcharge for plated base finishes as highlighted above.
R Rectangular	3. Base finish	Premium (Polished Chrome, Satin Nickel or Oil Rubbed Bronze)	For additional stone options and pricing please contact your sales representative."
48 Depth	4. Grommet option	Power Box Options	
84 Width	5. Grommet finish (only applies if grommets are selected)	Code: Description:	
G Glass	6. Power box option	NP No Power	
F1 1 Layer-Flat w/ Trim	7. Table-top power finish (only applies if table-top power is selected)	UCO Undermount	
M Metal Trim		ECO Table Top Lid	
GE01 Top Finish	Trim Type	T1E Tabletop 1-Sided Lid	
PM01 Trim Finish	N = No trim	T2C Tabletop 2-Sided Lid	
MC01 Base Finish	M = Metal (available in Premium and Powder Coat finishes)	Must select Wire Management Column and Finish:	
GM2 Grommet Opt.	L = Leather	Powder coated	
MC01 Grommet Finish		Premium (Polished Chrome, Satin Nickel or Oil Rubbed Bronze)	
UCO Undermount			

Rectangular Conference Tables

48" Deep Tops
2-Layer, Glass Tops

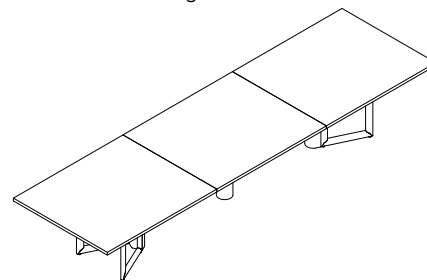

D	W	Pattern No.	GC__ Top	GE__ Top	T__ Lower Layer	HG__ Lower Layer	PM__ Edge Upcharge	AU__ Edge Upcharge	PM__ Base Upcharge
48"	84"	08VOFR4884GF2	\$22,627	\$23,280	\$531	\$581	\$605	\$2,116	\$2,181
48"	96"	08VOFR4896GF2	24,008	24,755	585	645	654	2,308	2,181
48"	108"	08VOFR48108GF2	25,389	26,228	648	712	703	2,501	2,181
48"	120"	08VOFR48120GF2	26,770	27,702	739	813	753	2,692	2,181
48"	132"	08VOFR48132GF2	28,152	29,177	789	868	834	2,885	2,181
48"	144"	08VOFR48144GF2	29,533	30,652	839	921	884	3,078	2,181
48"	156"	08VOFR48156GF2	30,914	32,126	845	930	933	3,270	2,181
48"	168"	08VOFR48168GF2	34,505	35,811	931	1,025	981	3,462	3,686
48"	180"	08VOFR48180GF2	35,714	37,113	1,029	1,132	1,030	3,654	3,686
48"	192"	08VOFR48192GF2	36,923	38,415	1,053	1,160	1,079	3,847	3,686
48"	204"	08VOFR48204GF2	38,132	39,717	1,110	1,220	1,128	4,040	3,686
48"	216"	08VOFR48216GF2	39,341	41,019	1,172	1,289	1,145	4,231	3,686
48"	228"	08VOFR48228GF2	40,549	42,321	1,232	1,356	1,227	4,457	3,686
48"	240"	08VOFR48240GF2	41,757	43,622	1,325	1,458	1,276	4,616	3,686

Order Code	Specification Information	Refer To Accessories Section	Pricing Tiers
Example: 08VOFR4884GF2M-GE01-PM01-MC01-GM2-MC01-UCO	To order please specify pattern number including:	Please refer to Accessories section, page 211 for power details.	Please refer to Materials and Finish page 7 for specification details.
08 Highline Collection	1. Top finish	Grommet options available in these finishes:	T1 and T2 pricing includes powder coated base finish.
VOF Vector Base	2. Trim Finish (only applies if trim type is metal or leather)	Powder coated	There is an upcharge for plated base finishes as highlighted above.
R Rectangular	3. Base finish	Premium (Polished Chrome, Satin Nickel or Oil Rubbed Bronze)	For additional stone options and pricing please contact your sales representative."
48 Depth	4. Grommet option	Power Box Options	
84 Width	5. Grommet finish (only applies if grommets are selected)	Code: Description:	
G Glass	6. Power box option	NP No Power	
F2 2 Layer-Flat w/ Trim	7. Table-top power finish (only applies if table-top power is selected)	UCO Undermount	
M Metal Trim		ECO Table Top Lid	
GE01 Top Finish	Trim Type	TIE Tabletop 1-Sided Lid	
PM01 Trim Finish	N = No trim	T2C Tabletop 2-Sided Lid	
MC01 Base Finish	M = Metal (available in Premium and Powder Coat finishes)	Must select Wire Management Column and Finish:	
GM2 Grommet Opt.	L = Leather	Powder coated	
MC01 Grommet Finish		Premium (Polished Chrome, Satin Nickel or Oil Rubbed Bronze)	
UCO Undermount			

Rectangular Conference Tables

48" Deep Tops
1-Layer, Corian Tops

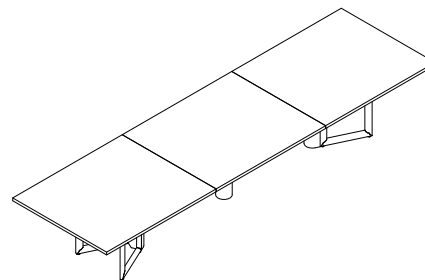

D	W	Pattern No.	CS01 Top	MC__ Edge Upchange	PM__ Edge Upchange	AU__ Edge Upchange	PM__ Base Upchange
48"	84"	08VOFR4884CF1	\$18,740	\$2,292	\$2,897	\$4,408	\$2,181
48"	96"	08VOFR4896CF1	20,233	2,463	3,117	4,771	2,181
48"	108"	08VOFR48108CF1	21,703	2,634	3,337	5,135	2,181
48"	120"	08VOFR48120CF1	23,218	2,806	3,559	5,498	2,181
48"	132"	08VOFR48132CF1	24,711	2,977	3,811	5,862	2,181
48"	144"	08VOFR48144CF1	26,204	3,147	4,031	6,225	2,181
48"	156"	08VOFR48156CF1	27,697	3,319	4,252	6,589	2,181
48"	168"	08VOFR48168CF1	30,201	3,583	4,564	7,045	3,686
48"	180"	08VOFR48180CF1	31,561	3,579	4,609	7,233	3,686
48"	192"	08VOFR48192CF1	32,921	3,575	4,654	7,422	3,686
48"	204"	08VOFR48204CF1	34,281	3,572	4,700	7,612	3,686
48"	216"	08VOFR48216CF1	35,641	3,568	4,713	7,799	3,686
48"	228"	08VOFR48228CF1	37,000	3,566	4,793	8,023	3,686
48"	240"	08VOFR48240CF1	38,357	3,567	4,843	8,183	3,686

Order Code	Specification Information	Refer To Accessories Section	Pricing Tiers
Example: 08VOFR4884CF1M-CS01-PM01-MC01-GM2-MC01-UC0	To order please specify pattern number including:	Please refer to Accessories section, page 211 for power details.	Please refer to Materials and Finish page 7 for specification details.
08 Highline Collection	1. Top finish	Grommet options available in these finishes:	T1 and T2 pricing includes powder coated base finish.
VOF Vector Base	2. Trim Finish (only applies if trim type is metal or leather)	Powder coated	There is an upcharge for plated base finishes as highlighted above.
R Rectangular	3. Base finish	Premium (Polished Chrome, Satin Nickel or Oil Rubbed Bronze)	For additional stone options and pricing please contact your sales representative."
48 Depth	4. Grommet option	Power Box Options	
84 Width	5. Grommet finish (only applies if grommets are selected)	Code: Description:	
C Corian	6. Power box option	NP No Power	
F1 1 Layer-Flat w/ Trim	7. Table-top power finish (only applies if table-top power is selected)	UCO Undermount	
M Metal Trim		ECO Table Top Lid	
CS01 Top Finish	Trim Type	T1E Tabletop 1-Sided Lid	
PM01 Trim Finish	N = No trim	T2C Tabletop 2-Sided Lid	
MC01 Base Finish	M = Metal (available in Premium and Powder Coat finishes)	Must select Wire Management Column and Finish:	
GM2 Grommet Opt.	L = Leather	Powder coated	
MC01 Grommet Finish		Premium (Polished Chrome, Satin Nickel or Oil Rubbed Bronze)	
UC0 Undermount			

Rectangular Conference Tables

48" Deep Tops
2-Layer, Corian Tops

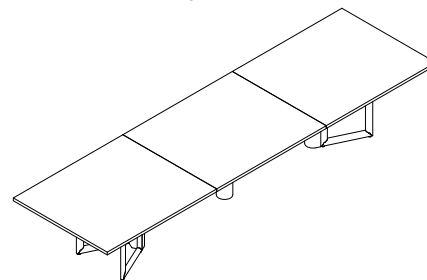

D	W	Pattern No.	CS01 Top	T__ Lower Layer	HG__ Lower Layer	PM__ Edge Upcharge	AU__ Edge Upcharge	PM__ Base Upcharge
48"	84"	08VOFR4884CF2	\$23,150	\$531	\$581	\$605	\$2,116	\$2,181
48"	96"	08VOFR4896CF2	24,681	585	645	654	2,308	2,181
48"	108"	08VOFR48108CF2	26,189	648	712	703	2,501	2,181
48"	120"	08VOFR48120CF2	27,742	739	813	753	2,692	2,181
48"	132"	08VOFR48132CF2	29,274	789	868	834	2,885	2,181
48"	144"	08VOFR48144CF2	30,804	839	921	884	3,078	2,181
48"	156"	08VOFR48156CF2	32,336	845	930	933	3,270	2,181
48"	168"	08VOFR48168CF2	35,987	931	1,025	981	3,462	3,686
48"	180"	08VOFR48180CF2	37,353	1,029	1,132	1,030	3,654	3,686
48"	192"	08VOFR48192CF2	38,718	1,053	1,160	1,079	3,847	3,686
48"	204"	08VOFR48204CF2	40,083	1,110	1,220	1,128	4,040	3,686
48"	216"	08VOFR48216CF2	41,449	1,172	1,289	1,145	4,231	3,686
48"	228"	08VOFR48228CF2	42,814	1,232	1,356	1,227	4,457	3,686
48"	240"	08VOFR48240CF2	44,179	1,325	1,458	1,276	4,616	3,686

Order Code	Specification Information	Refer To Accessories Section	Pricing Tiers
Example: 08VOFR4884CF2M-CS01-PM01-MC01-GM2-MC01-UCO	To order please specify pattern number including:	Please refer to Accessories section, page 211 for power details.	Please refer to Materials and Finish page 7 for specification details.
08 Highline Collection	1. Top finish	Grommet options available in these finishes:	T1 and T2 pricing includes powder coated base finish.
VOF Vector Base	2. Trim Finish (only applies if trim type is metal or leather)	Powder coated	There is an upcharge for plated base finishes as highlighted above.
R Rectangular	3. Base finish	Premium (Polished Chrome, Satin Nickel or Oil Rubbed Bronze)	For additional stone options and pricing please contact your sales representative."
48 Depth	4. Grommet option	Power Box Options	
84 Width	5. Grommet finish (only applies if grommets are selected)	Code: Description:	
C Corian	6. Power box option	NP No Power	
F2 2 Layer-Flat w/ Trim	7. Table-top power finish (only applies if table-top power is selected)	UCO Undermount	
M Metal Trim		ECO Table Top Lid	
CS01 Top Finish	Trim Type	T1E Tabletop 1-Sided Lid	
PM01 Trim Finish	N = No trim	T2C Tabletop 2-Sided Lid	
MC01 Base Finish	M = Metal (available in Premium and Powder Coat finishes)	Must select Wire Management Column and Finish:	
GM2 Grommet Opt.	L = Leather	Powder coated	
MC01 Grommet Finish		Premium (Polished Chrome, Satin Nickel or Oil Rubbed Bronze)	
UCO Undermount			

Rectangular Conference Tables

54" Deep Tops
1-Layer, Veneer Tops

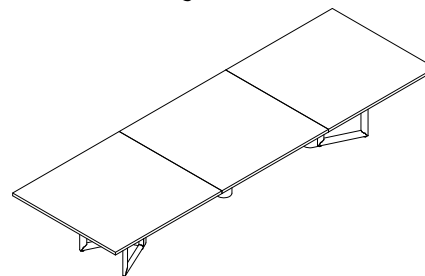

D	W	Pattern No.	T1__ Top	T2__ Top	MC__ Edge Upcharge	PM__ Edge Upcharge	AU__ Edge Upcharge	PM__ Base Upcharge
54"	84"	08VOFR5484VF1	\$14,833	\$15,656	\$2,319	\$2,952	\$4,550	\$2,181
54"	96"	08VOFR5496VF1	15,768	16,694	2,491	3,169	4,896	2,181
54"	108"	08VOFR54108VF1	16,703	17,745	2,665	3,393	5,261	2,181
54"	120"	08VOFR54120VF1	17,639	18,795	2,838	3,615	5,627	2,181
54"	132"	08VOFR54132VF1	18,573	19,846	3,011	3,869	5,992	2,181
54"	144"	08VOFR54144VF1	19,508	20,896	3,185	4,093	6,359	2,181
54"	156"	08VOFR54156VF1	20,443	21,946	3,357	4,314	6,723	2,181
54"	168"	08VOFR54168VF1	22,411	24,032	3,617	4,622	7,175	3,686
54"	180"	08VOFR54180VF1	23,210	24,944	3,614	4,668	7,365	3,686
54"	192"	08VOFR54192VF1	24,007	25,859	3,615	4,718	7,558	3,686
54"	204"	08VOFR54204VF1	24,806	26,774	3,614	4,767	7,749	3,686
54"	216"	08VOFR54216VF1	25,605	27,688	3,611	4,813	7,939	3,686
54"	228"	08VOFR54228VF1	26,403	28,602	3,611	4,862	8,131	3,686
54"	240"	08VOFR54240VF1	27,203	29,519	3,606	4,906	8,319	3,686

Order Code	Specification Information	Refer To Accessories Section	Pricing Tiers
Example: 08VOFR5484VF1M-T003-PM01-MC01-GM2-MC01-UCO	To order please specify pattern number including:	Please refer to Accessories section, page 211 for power details.	Please refer to Materials and Finish page 7 for specification details.
08 Highline Collection	1. Top finish	Grommet options available in these finishes:	T1 and T2 pricing includes powder coated base finish.
VOF Vector Base	2. Trim Finish (only applies if trim type is metal or leather)	Powder coated	There is an upcharge for plated base finishes as highlighted above.
R Rectangular	3. Base finish	Premium (Polished Chrome, Satin Nickel or Oil Rubbed Bronze)	For additional stone options and pricing please contact your sales representative."
54 Depth	4. Grommet option	Power Box Options	
84 Width	5. Grommet finish (only applies if grommets are selected)	Code: Description:	
V Veneer	6. Power box option	NP No Power	
F1 1 Layer-Flat w/ Trim	7. Table-top power finish (only applies if table-top power is selected)	UCO Undermount	
M Metal Trim		ECO Table Top Lid	
T003 Top Finish	Trim Type	T1E Tabletop 1-Sided Lid	
PM01 Trim Finish	N = No trim	T2C Tabletop 2-Sided Lid	
MC01 Base Finish	M = Metal (available in Premium and Powder Coat finishes)	Must select Wire Management Column and Finish:	
GM2 Grommet Opt.	L = Leather	Powder coated	
MC01 Grommet Finish		Premium (Polished Chrome, Satin Nickel or Oil Rubbed Bronze)	
UCO Undermount			

Rectangular Conference Tables

54" Deep Tops
2-Layer, Veneer Tops

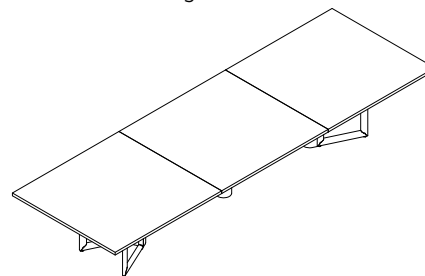

D	W	Pattern No.	T1__ Top	T2__ Top	T__ Lower Layer	HG__ Lower Layer	PM__ Edge Upcharge	AU__ Edge Upcharge	PM__ Base Upcharge
54"	84"	08VOFR5484VF2	\$19,153	\$19,874	\$557	\$666	\$633	\$2,231	\$2,181
54"	96"	08VOFR5496VF2	20,179	21,105	657	724	678	2,405	2,181
54"	108"	08VOFR54108VF2	21,204	22,247	728	802	728	2,596	2,181
54"	120"	08VOFR54120VF2	22,230	23,387	832	916	777	2,789	2,181
54"	132"	08VOFR54132VF2	23,255	24,529	887	976	858	2,981	2,181
54"	144"	08VOFR54144VF2	24,281	25,670	944	1,037	908	3,174	2,181
54"	156"	08VOFR54156VF2	25,302	26,807	951	1,045	957	3,366	2,181
54"	168"	08VOFR54168VF2	27,971	29,591	1,046	1,150	1,005	3,558	3,686
54"	180"	08VOFR54180VF2	28,754	30,489	1,158	1,273	1,054	3,751	3,686
54"	192"	08VOFR54192VF2	29,537	31,388	1,185	1,304	1,103	3,943	3,686
54"	204"	08VOFR54204VF2	30,319	32,288	1,249	1,373	1,153	4,135	3,686
54"	216"	08VOFR54216VF2	31,102	33,185	1,317	1,449	1,202	4,328	3,686
54"	228"	08VOFR54228VF2	31,885	34,083	1,387	1,526	1,251	4,520	3,686
54"	240"	08VOFR54240VF2	32,666	34,980	1,491	1,639	1,300	4,713	3,686

Order Code	Specification Information	Refer To Accessories Section	Pricing Tiers
Example: 08VOFR5484VF2M-T003-PM01-MC01-GM2-MC01-UC0	To order please specify pattern number including:	Please refer to Accessories section, page 211 for power details.	Please refer to Materials and Finish page 7 for specification details.
08 Highline Collection	1. Top finish	Grommet options available in these finishes:	T1 and T2 pricing includes powder coated base finish.
VOF Vector Base	2. Trim Finish (only applies if trim type is metal or leather)	Powder coated	There is an upcharge for plated base finishes as highlighted above.
R Rectangular	3. Base finish	Premium (Polished Chrome, Satin Nickel or Oil Rubbed Bronze)	For additional stone options and pricing please contact your sales representative."
54 Depth	4. Grommet option	Power Box Options	
84 Width	5. Grommet finish (only applies if grommets are selected)	Code: Description:	
V Veneer	6. Power box option	NP No Power	
F2 2 Layer-Flat w/ Trim	7. Table-top power finish (only applies if table-top power is selected)	UC0 Undermount	
M Metal Trim		ECO Table Top Lid	
T003 Top Finish	Trim Type	T1E Tabletop 1-Sided Lid	
PM01 Trim Finish	N = No trim	T2C Tabletop 2-Sided Lid	
MC01 Base Finish	M = Metal (available in Premium and Powder Coat finishes)	Must select Wire Management Column and Finish:	
GM2 Grommet Opt.	L = Leather	Powder coated	
MC01 Grommet Finish		Premium (Polished Chrome, Satin Nickel or Oil Rubbed Bronze)	
UC0 Undermount			

Rectangular Conference Tables

54" Deep Tops
Slab Top, Veneer Tops

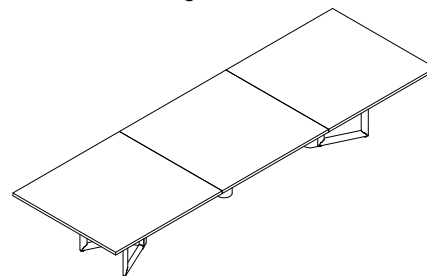

D	W	Pattern No.	T1__ Top	T2__ Top	MC__ Edge Upcharge	PM__ Edge Upcharge	AU__ Edge Upcharge	PM__ Base Upcharge
54"	84"	08VOFR5484VSF	\$16,836	\$17,658	\$2,317	\$2,950	\$4,548	\$2,181
54"	96"	08VOFR5496VSF	17,688	18,613	2,491	3,169	4,896	2,181
54"	108"	08VOFR54108VSF	18,540	19,582	2,664	3,392	5,260	2,181
54"	120"	08VOFR54120VSF	19,392	20,549	2,838	3,615	5,627	2,181
54"	132"	08VOFR54132VSF	20,244	21,517	3,011	3,869	5,992	2,181
54"	144"	08VOFR54144VSF	21,096	22,484	3,185	4,093	6,359	2,181
54"	156"	08VOFR54156VSF	21,945	23,450	3,357	4,314	6,723	2,181
54"	168"	08VOFR54168VSF	24,354	25,974	3,617	4,622	7,175	3,686
54"	180"	08VOFR54180VSF	25,138	26,874	3,616	4,670	7,367	3,686
54"	192"	08VOFR54192VSF	25,922	27,774	3,615	4,718	7,558	3,686
54"	204"	08VOFR54204VSF	26,706	28,674	3,613	4,766	7,748	3,686
54"	216"	08VOFR54216VSF	27,490	29,573	3,612	4,814	7,940	3,686
54"	228"	08VOFR54228VSF	28,274	30,473	3,611	4,862	8,131	3,686
54"	240"	08VOFR54240VSF	29,060	31,375	3,606	4,906	8,319	3,686

Order Code	Specification Information	Refer To Accessories Section	Pricing Tiers
Example: 08VOFR5484VSFM-T003-PM01-MC01-GM2-MC01-UCO	To order please specify pattern number including:	Please refer to Accessories section, page 211 for power details.	Please refer to Materials and Finish page 7 for specification details.
08 Highline Collection	1. Top finish	Grommet options available in these finishes:	T1 and T2 pricing includes powder coated base finish.
VOF Vector Base	2. Trim Finish (only applies if trim type is metal or leather)	Powder coated	There is an upcharge for plated base finishes as highlighted above.
R Rectangular	3. Base finish	Premium (Polished Chrome, Satin Nickel or Oil Rubbed Bronze)	For additional stone options and pricing please contact your sales representative."
54 Depth	4. Grommet option	Power Box Options	
84 Width	5. Grommet finish (only applies if grommets are selected)	Code: Description:	
V Veneer	6. Power box option	NP No Power	
SF Slab	7. Table-top power finish (only applies if table-top power is selected)	UCO Undermount	
M Metal Trim		ECO Table Top Lid	
T003 Top Finish	Trim Type	T1E Tabletop 1-Sided Lid	
PM01 Trim Finish	N = No trim	T2C Tabletop 2-Sided Lid	
MC01 Base Finish	M = Metal (available in Premium and Powder Coat finishes)	Must select Wire Management Column and Finish:	
GM2 Grommet Opt.	L = Leather	Powder coated	
MC01 Grommet Finish		Premium (Polished Chrome, Satin Nickel or Oil Rubbed Bronze)	
UCO Undermount			

Rectangular Conference Tables

54" Deep Tops
1-Layer, Glass Tops

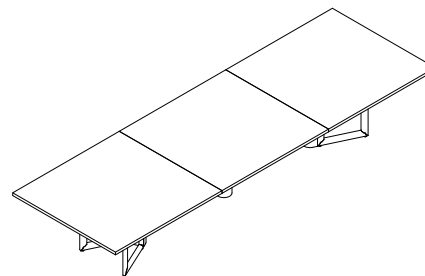

D	W	Pattern No.	GC__ Top	GE__ Top	PM__ Edge Upcharge	AU__ Edge Upcharge	PM__ Base Upcharge
54"	84"	08VOFR5484GF1	\$21,547	\$22,254	\$633	\$2,231	\$2,181
54"	96"	08VOFR5496GF1	23,186	24,025	678	2,405	2,181
54"	108"	08VOFR54108GF1	24,861	25,804	728	2,596	2,181
54"	120"	08VOFR54120GF1	26,533	27,582	777	2,789	2,181
54"	132"	08VOFR54132GF1	28,207	29,362	858	2,981	2,181
54"	144"	08VOFR54144GF1	29,882	31,141	908	3,174	2,181
54"	156"	08VOFR54156GF1	31,555	32,918	957	3,366	2,181
54"	168"	08VOFR54168GF1	34,397	35,865	1,005	3,558	3,686
54"	180"	08VOFR54180GF1	35,746	37,319	1,054	3,751	3,686
54"	192"	08VOFR54192GF1	37,096	38,775	1,103	3,943	3,686
54"	204"	08VOFR54204GF1	38,447	40,231	1,153	4,135	3,686
54"	216"	08VOFR54216GF1	39,797	41,685	1,202	4,328	3,686
54"	228"	08VOFR54228GF1	41,148	43,141	1,251	4,520	3,686
54"	240"	08VOFR54240GF1	42,495	44,593	1,300	4,713	3,686

Order Code	Specification Information	Refer To Accessories Section	Pricing Tiers
Example: 08VOFR5484GF1M-GE01-PM01-MC01-GM2-MC01-UC0	To order please specify pattern number including:	Please refer to Accessories section, page 211 for power details.	Please refer to Materials and Finish page 7 for specification details.
08 Highline Collection	1. Top finish	Grommet options available in these finishes:	T1 and T2 pricing includes powder coated base finish.
VOF Vector Base	2. Trim Finish (only applies if trim type is metal or leather)	Powder coated	There is an upcharge for plated base finishes as highlighted above.
R Rectangular	3. Base finish	Premium (Polished Chrome, Satin Nickel or Oil Rubbed Bronze)	For additional stone options and pricing please contact your sales representative."
54 Depth	4. Grommet option	Power Box Options	
84 Width	5. Grommet finish (only applies if grommets are selected)	Code: Description:	
G Glass	6. Power box option	NP No Power	
F1 1 Layer-Flat w/ Trim	7. Table-top power finish (only applies if table-top power is selected)	UCO Undermount	
M Metal Trim		ECO Table Top Lid	
GE01 Top Finish	Trim Type	T1E Tabletop 1-Sided Lid	
PM01 Trim Finish	N = No trim	T2C Tabletop 2-Sided Lid	
MC01 Base Finish	M = Metal (available in Premium and Powder Coat finishes)	Must select Wire Management Column and Finish:	
GM2 Grommet Opt.	L = Leather	Powder coated	
MC01 Grommet Finish		Premium (Polished Chrome, Satin Nickel or Oil Rubbed Bronze)	
UC0 Undermount			

Rectangular Conference Tables

54" Deep Tops
2-Layer, Glass Tops

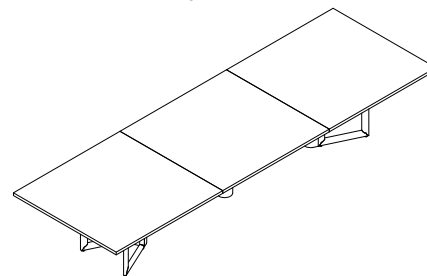

D	W	Pattern No.	GC__ Top	GE__ Top	T__ Lower Layer	HG__ Lower Layer	PM__ Edge Upcharge	AU__ Edge Upcharge	PM__ EdgeBase Upcharge
54"	84"	08VOFR5484GF2	\$23,193	\$23,846	\$557	\$666	\$633	\$2,231	\$2,181
54"	96"	08VOFR5496GF2	25,185	26,024	657	724	678	2,405	2,181
54"	108"	08VOFR54108GF2	26,774	27,718	728	802	728	2,596	2,181
54"	120"	08VOFR54120GF2	28,362	29,411	832	916	777	2,789	2,181
54"	132"	08VOFR54132GF2	29,949	31,102	887	976	858	2,981	2,181
54"	144"	08VOFR54144GF2	31,537	32,796	944	1,037	908	3,174	2,181
54"	156"	08VOFR54156GF2	33,121	34,484	951	1,045	957	3,366	2,181
54"	168"	08VOFR54168GF2	36,422	37,891	1,046	1,150	1,005	3,558	3,686
54"	180"	08VOFR54180GF2	37,757	39,330	1,158	1,273	1,054	3,751	3,686
54"	192"	08VOFR54192GF2	39,092	40,770	1,185	1,304	1,103	3,943	3,686
54"	204"	08VOFR54204GF2	40,427	42,211	1,249	1,373	1,153	4,135	3,686
54"	216"	08VOFR54216GF2	41,763	43,651	1,317	1,449	1,202	4,328	3,686
54"	228"	08VOFR54228GF2	43,098	45,090	1,387	1,526	1,251	4,520	3,686
54"	240"	08VOFR54240GF2	44,430	46,528	1,491	1,639	1,300	4,713	3,686

Order Code	Specification Information	Refer To Accessories Section	Pricing Tiers
Example: 08VOFR5484GF2M-GE01-PM01-MC01-GM2-MC01-UC0	To order please specify pattern number including:	Please refer to Accessories section, page 211 for power details.	Please refer to Materials and Finish page 7 for specification details.
08 Highline Collection	1. Top finish	Grommet options available in these finishes:	T1 and T2 pricing includes powder coated base finish.
VOF Vector Base	2. Trim Finish (only applies if trim type is metal or leather)	Powder coated	There is an upcharge for plated base finishes as highlighted above.
R Rectangular	3. Base finish	Premium (Polished Chrome, Satin Nickel or Oil Rubbed Bronze)	For additional stone options and pricing please contact your sales representative."
54 Depth	4. Grommet option	Power Box Options	
84 Width	5. Grommet finish (only applies if grommets are selected)	Code: Description:	
G Glass	6. Power box option	NP No Power	
F2 2 Layer-Flat w/ Trim	7. Table-top power finish (only applies if table-top power is selected)	UCO Undermount	
M Metal Trim		ECO Table Top Lid	
GE01 Top Finish	Trim Type	T1E Tabletop 1-Sided Lid	
PM01 Trim Finish	N = No trim	T2C Tabletop 2-Sided Lid	
MC01 Base Finish	M = Metal (available in Premium and Powder Coat finishes)	Must select Wire Management Column and Finish:	
GM2 Grommet Opt.	L = Leather	Powder coated	
MC01 Grommet Finish		Premium (Polished Chrome, Satin Nickel or Oil Rubbed Bronze)	
UC0 Undermount			

Rectangular Conference Tables

54" Deep Tops
1-Layer, Corian Tops

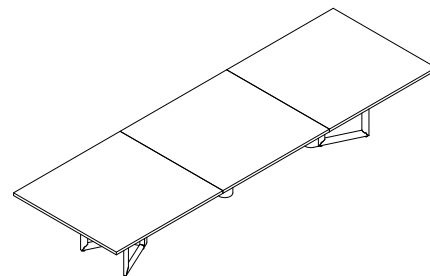

D	W	Pattern No.	CS01 Top	MC__ Edge Upcharge	PM__ Edge Upcharge	AU__ Edge Upcharge	PM__ Base Upcharge
54"	84"	08VOFR5484CF1	\$19,944	\$2,318	\$2,951	\$4,549	\$2,181
54"	96"	08VOFR5496CF1	21,606	2,491	3,169	4,896	2,181
54"	108"	08VOFR54108CF1	23,271	2,665	3,393	5,261	2,181
54"	120"	08VOFR54120CF1	24,935	2,838	3,615	5,627	2,181
54"	132"	08VOFR54132CF1	26,598	3,012	3,870	5,993	2,181
54"	144"	08VOFR54144CF1	28,264	3,184	4,092	6,358	2,181
54"	156"	08VOFR54156CF1	29,928	3,356	4,313	6,722	2,181
54"	168"	08VOFR54168CF1	32,626	3,617	4,622	7,175	3,686
54"	180"	08VOFR54180CF1	34,153	3,616	4,670	7,367	3,686
54"	192"	08VOFR54192CF1	35,684	3,613	4,716	7,556	3,686
54"	204"	08VOFR54204CF1	37,211	3,613	4,766	7,748	3,686
54"	216"	08VOFR54216CF1	38,738	3,613	4,815	7,941	3,686
54"	228"	08VOFR54228CF1	40,266	3,611	4,862	8,131	3,686
54"	240"	08VOFR54240CF1	41,797	3,605	4,905	8,318	3,686

Order Code	Specification Information	Refer To Accessories Section	Pricing Tiers
Example: 08VOFR5484CF1M-CS01-PM01-MC01-GM2-MC01-UC0	To order please specify pattern number including:	Please refer to Accessories section, page 211 for power details.	Please refer to Materials and Finish page 7 for specification details.
08 Highline Collection	1. Top finish	Grommet options available in these finishes:	T1 and T2 pricing includes powder coated base finish.
VOF Vector Base	2. Trim Finish (only applies if trim type is metal or leather)	Powder coated	There is an upcharge for plated base finishes as highlighted above.
R Rectangular	3. Base finish	Premium (Polished Chrome, Satin Nickel or Oil Rubbed Bronze)	For additional stone options and pricing please contact your sales representative."
54 Depth	4. Grommet option	Power Box Options	
84 Width	5. Grommet finish (only applies if grommets are selected)	Code: Description:	
C Corian	6. Power box option	NP No Power	
F1 1 Layer-Flat w/ Trim	7. Table-top power finish (only applies if table-top power is selected)	UCO Undermount	
M Metal Trim	Trim Type	ECO Table Top Lid	
CS01 Top Finish	N = No trim	T1E Tabletop 1-Sided Lid	
PM01 Trim Finish	M = Metal (available in Premium and Powder Coat finishes)	T2C Tabletop 2-Sided Lid	
MC01 Base Finish	L = Leather	Must select Wire Management Column and Finish:	
GM2 Grommet Opt.		Powder coated	
MC01 Grommet Finish		Premium (Polished Chrome, Satin Nickel or Oil Rubbed Bronze)	
UC0 Undermount			

Rectangular Conference Tables

54" Deep Tops
2-Layer, Corian Tops

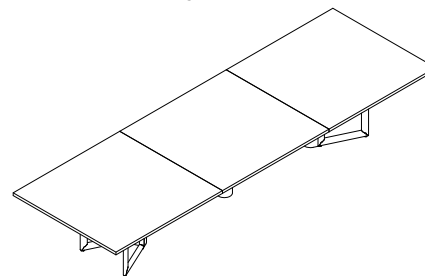

D	W	Pattern No.	CS01 Top	T__ Lower Layer	HG__ Lower Layer	PM__ Edge Upcharge	AU__ Edge Upcharge	PM__ Base Upcharge
54"	84"	08VOFR5484CF2	\$23,693	\$557	\$666	\$633	\$2,231	\$2,181
54"	96"	08VOFR5496CF2	26,016	657	724	678	2,405	2,181
54"	108"	08VOFR54108CF2	27,772	728	802	728	2,596	2,181
54"	120"	08VOFR54120CF2	29,526	832	916	777	2,789	2,181
54"	132"	08VOFR54132CF2	31,281	887	976	858	2,981	2,181
54"	144"	08VOFR54144CF2	33,036	944	1,037	908	3,174	2,181
54"	156"	08VOFR54156CF2	34,787	951	1,045	957	3,366	2,181
54"	168"	08VOFR54168CF2	38,186	1,046	1,150	1,005	3,558	3,686
54"	180"	08VOFR54180CF2	39,698	1,158	1,273	1,054	3,751	3,686
54"	192"	08VOFR54192CF2	41,212	1,185	1,304	1,103	3,943	3,686
54"	204"	08VOFR54204CF2	42,724	1,249	1,373	1,153	4,135	3,686
54"	216"	08VOFR54216CF2	44,236	1,317	1,449	1,202	4,328	3,686
54"	228"	08VOFR54228CF2	45,748	1,387	1,526	1,251	4,520	3,686
54"	240"	08VOFR54240CF2	47,258	1,491	1,639	1,300	4,713	3,686

Order Code	Specification Information	Refer To Accessories Section	Pricing Tiers
Example: 08VOFR5484CF2M-CS01-PM01-MC01-GM2-MC01-UCO	To order please specify pattern number including:	Please refer to Accessories section, page 211 for power details.	Please refer to Materials and Finish page 7 for specification details.
08 Highline Collection	1. Top finish	Grommet options available in these finishes:	T1 and T2 pricing includes powder coated base finish.
VOF Vector Base	2. Trim Finish (only applies if trim type is metal or leather)	Powder coated	There is an upcharge for plated base finishes as highlighted above.
R Rectangular	3. Base finish	Premium (Polished Chrome, Satin Nickel or Oil Rubbed Bronze)	For additional stone options and pricing please contact your sales representative."
54 Depth	4. Grommet option	Power Box Options	
84 Width	5. Grommet finish (only applies if grommets are selected)	Code: Description:	
C Corian	6. Power box option	NP No Power	
F2 2 Layer-Flat w/ Trim	7. Table-top power finish (only applies if table-top power is selected)	UCO Undermount	
M Metal Trim		ECO Table Top Lid	
CS01 Top Finish	Trim Type	T1E Tabletop 1-Sided Lid	
PM01 Trim Finish	N = No trim	T2C Tabletop 2-Sided Lid	
MC01 Base Finish	M = Metal (available in Premium and Powder Coat finishes)	Must select Wire Management Column and Finish:	
GM2 Grommet Opt.	L = Leather	Powder coated	
MC01 Grommet Finish		Premium (Polished Chrome, Satin Nickel or Oil Rubbed Bronze)	
UCO Undermount			

Highline Vector Conference Tables

60" Deep Conference Tables

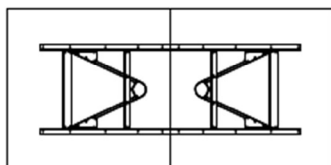
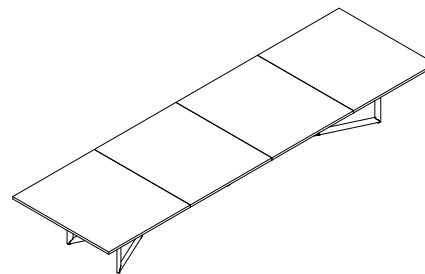

120L
SEATS 12

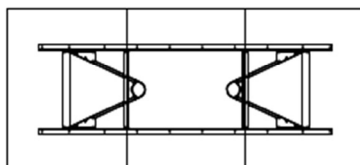

132L
SEATS 12

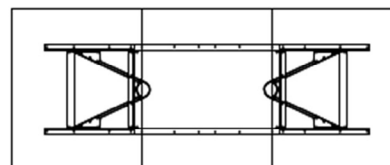

144L
SEATS 12

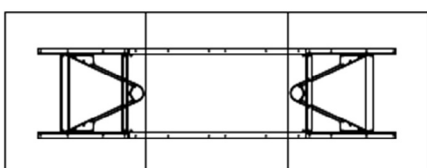

156L
SEATS 12

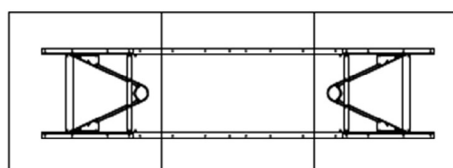

168L
SEATS 14

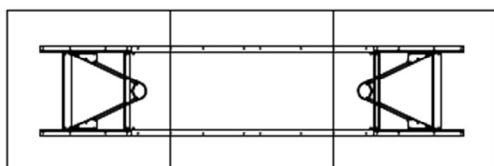

180L
SEATS 16

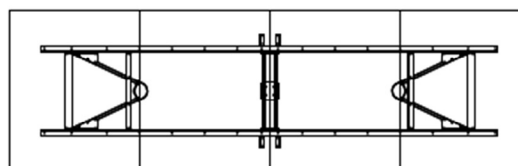

192L
SEATS 16

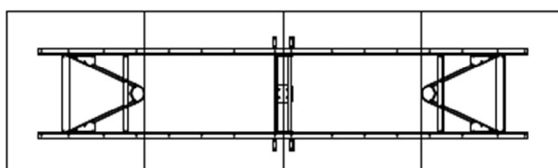

204L
SEATS 16

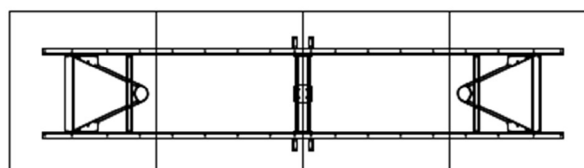

216L
SEATS 18

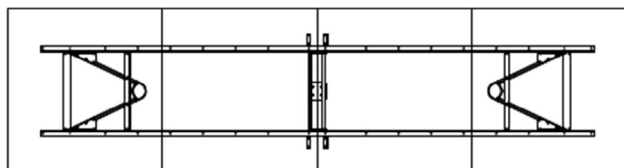

228L
SEATS 18

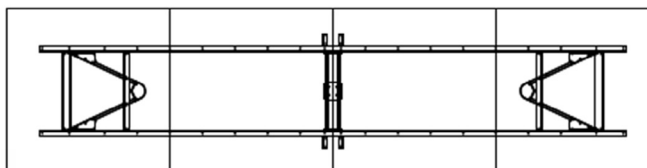

240L
SEATS 20

Highline Vector Conference Tables

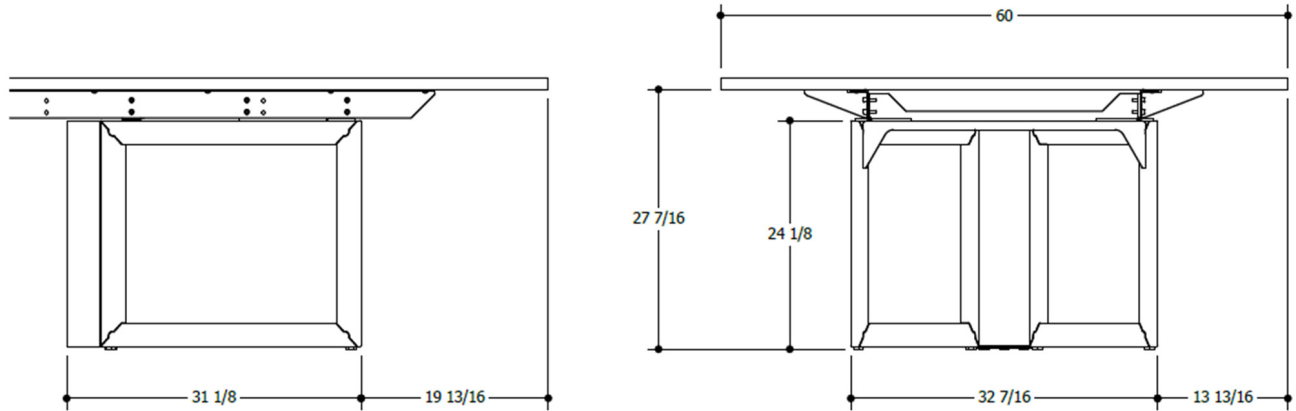
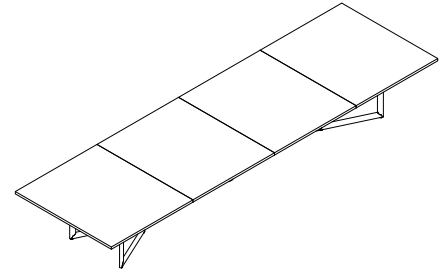

END BASE ELEVATION, 60D

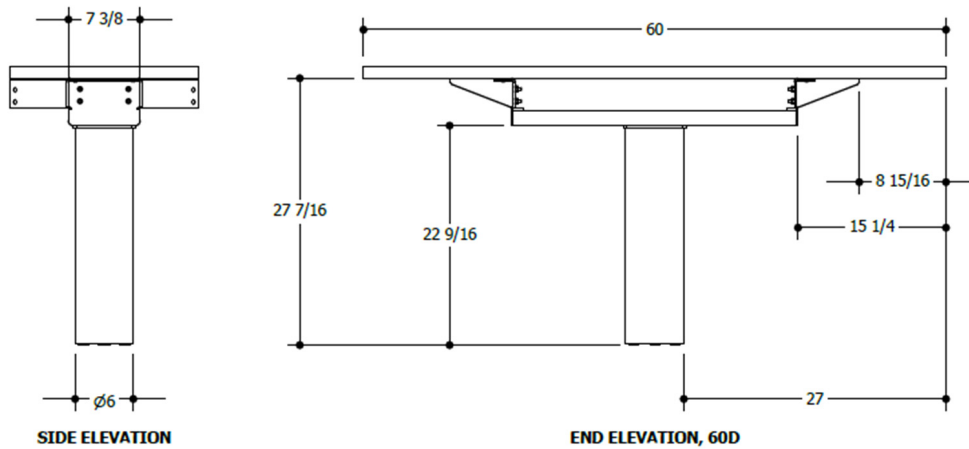

SIDE ELEVATION

END ELEVATION, 60D

Rectangular Conference Tables

60" Deep Tops
1-Layer, Veneer Tops

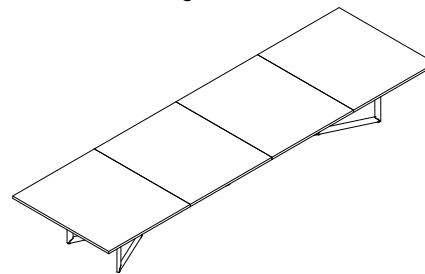

D	W	Pattern No.	T1__ Top	T2__ Top	MC__ Edge Upcharge	PM__ Edge Upcharge	AU__ Edge Upcharge	PM__ Base Upcharge
60"	120"	08VOFR60120VF1	\$15,744	\$17,029	\$2,295	\$3,097	\$5,180	\$2,290
60"	132"	08VOFR60132VF1	17,338	18,754	2,516	3,400	5,594	2,290
60"	144"	08VOFR60144VF1	18,934	20,477	2,734	3,667	6,004	2,290
60"	156"	08VOFR60156VF1	20,528	22,200	2,955	3,936	7,323	2,290
60"	168"	08VOFR60168VF1	22,122	23,923	3,176	4,206	6,830	2,290
60"	180"	08VOFR60180VF1	23,714	25,644	3,398	4,477	7,245	2,290
60"	192"	08VOFR60192VF1	25,684	27,741	3,615	4,743	7,655	3,796
60"	204"	08VOFR60204VF1	26,596	28,783	3,600	4,778	7,831	3,796
60"	216"	08VOFR60216VF1	27,509	29,824	3,584	4,811	8,008	3,796
60"	228"	08VOFR60228VF1	28,422	30,865	3,567	4,843	8,183	3,796
60"	240"	08VOFR60240VF1	29,335	31,907	3,553	4,878	8,361	3,796

Order Code	Specification Information	Refer To Accessories Section	Pricing Tiers
Example: 08VOFR60120VF1M-T003-PM01-MC01-GM2-MC01-UCO	To order please specify pattern number including:	Please refer to Accessories section, page 211 for power details.	Please refer to Materials and Finish page 7 for specification details.
08 Highline Collection	1. Top finish	Grommet options available in these finishes:	T1 and T2 pricing includes powder coated base finish.
VOF Vector Base	2. Trim Finish (only applies if trim type is metal or leather)	Powder coated	There is an upcharge for plated base finishes as highlighted above.
R Rectangular	3. Base finish	Premium (Polished Chrome, Satin Nickel or Oil Rubbed Bronze)	For additional stone options and pricing please contact your sales representative."
60 Depth	4. Grommet option	Power Box Options	
120 Width	5. Grommet finish (only applies if grommets are selected)	Code: Description:	
V Veneer	6. Power box option	NP No Power	
F1 1 Layer-Flat w/ Trim	7. Table-top power finish (only applies if table-top power is selected)	UCO Undermount	
M Metal Trim		ECO Table Top Lid	
T003 Top Finish	Trim Type	T1E Tabletop 1-Sided Lid	
PM01 Trim Finish	N = No trim	T2C Tabletop 2-Sided Lid	
MC01 Base Finish	M = Metal (available in Premium and Powder Coat finishes)	Must select Wire Management	
GM2 Grommet Opt.	L = Leather	Column and Finish:	
MC01 Grommet Finish		Powder coated	
UCO Undermount		Premium (Polished Chrome, Satin Nickel or Oil Rubbed Bronze)	

Rectangular Conference Tables

60" Deep Tops
2-Layer, Veneer Tops

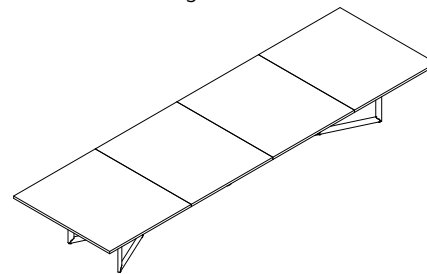

D	W	Pattern No.	T1__ Top	T2__ Top	T__ Lower Layer	HG__ Lower Layer	PM__ Edge Upcharge	AU__ Edge Upcharge	PM__ Base Upcharge
60"	120"	08VOFR60120VF2	\$19,972	\$21,258	\$807	\$888	\$802	\$2,885	\$2,290
60"	132"	08VOFR60132VF2	21,642	23,056	899	989	884	3,078	2,290
60"	144"	08VOFR60144VF2	23,311	24,854	955	1,051	933	3,270	2,290
60"	156"	08VOFR60156VF2	24,981	26,653	1,023	1,125	981	4,368	2,290
60"	168"	08VOFR60168VF2	26,651	28,450	1,078	1,186	1,030	3,654	2,290
60"	180"	08VOFR60180VF2	28,322	30,251	1,115	1,228	1,079	3,847	2,290
60"	192"	08VOFR60192VF2	30,758	32,816	1,214	1,337	1,128	4,040	3,796
60"	204"	08VOFR60204VF2	31,668	33,854	1,281	1,410	1,178	4,231	3,796
60"	216"	08VOFR60216VF2	32,577	34,892	1,313	1,445	1,227	4,424	3,796
60"	228"	08VOFR60228VF2	33,486	35,930	1,418	1,560	1,276	4,616	3,796
60"	240"	08VOFR60240VF2	34,393	36,965	1,485	1,635	1,325	4,808	3,796

Order Code	Specification Information	Refer To Accessories Section	Pricing Tiers
Example: 08VOFR60120VF2M-T003-PM01-MC01-GM2-MC01-UCO	To order please specify pattern number including:	Please refer to Accessories section, page 211 for power details.	Please refer to Materials and Finish page 7 for specification details.
08 Highline Collection	1. Top finish	Grommet options available in these finishes:	T1 and T2 pricing includes powder coated base finish.
VOF Vector Base	2. Trim Finish (only applies if trim type is metal or leather)	Powder coated	There is an upcharge for plated base finishes as highlighted above.
R Rectangular	3. Base finish	Premium (Polished Chrome, Satin Nickel or Oil Rubbed Bronze)	For additional stone options and pricing please contact your sales representative."
60 Depth	4. Grommet option	Power Box Options	
120 Width	5. Grommet finish (only applies if grommets are selected)	Code: Description:	
V Veneer	6. Power box option	NP No Power	
F2 2 Layer-Flat w/ Trim	7. Table-top power finish (only applies if table-top power is selected)	UCO Undermount	
M Metal Trim		ECO Table Top Lid	
T003 Top Finish	Trim Type	T1E Tabletop 1-Sided Lid	
PM01 Trim Finish	N = No trim	T2C Tabletop 2-Sided Lid	
MC01 Base Finish	M = Metal (available in Premium and Powder Coat finishes)	Must select Wire Management	
GM2 Grommet Opt.	L = Leather	Column and Finish:	
MC01 Grommet Finish		Powder coated	
UCO Undermount		Premium (Polished Chrome, Satin Nickel or Oil Rubbed Bronze)	

Rectangular Conference Tables

60" Deep Tops
Slab Top, Veneer Tops

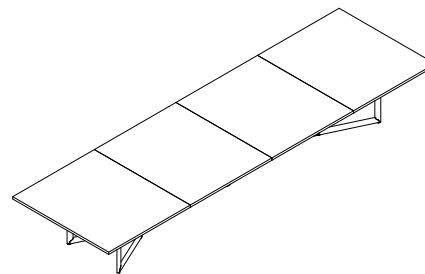

D	W	Pattern No.	T1__ Top	T2__ Top	MC__ Edge Upcharge	PM__ Edge Upcharge	AU__ Edge Upcharge	PM__ Base Upcharge
60"	120"	08VOFR60120VSF	\$17,677	\$18,963	\$2,295	\$3,097	\$5,180	\$2,290
60"	132"	08VOFR60132VSF	19,126	20,541	2,516	3,400	5,594	2,290
60"	144"	08VOFR60144VSF	20,576	22,119	2,735	3,668	6,005	2,290
60"	156"	08VOFR60156VSF	22,025	23,697	2,956	3,937	7,324	2,290
60"	168"	08VOFR60168VSF	23,475	25,275	3,176	4,206	6,830	2,290
60"	180"	08VOFR60180VSF	24,924	26,854	3,398	4,477	7,245	2,290
60"	192"	08VOFR60192VSF	27,144	29,201	3,614	4,742	7,654	3,796
60"	204"	08VOFR60204VSF	28,068	30,255	3,600	4,778	7,831	3,796
60"	216"	08VOFR60216VSF	28,992	31,308	3,585	4,812	8,009	3,796
60"	228"	08VOFR60228VSF	29,918	32,361	3,568	4,844	8,184	3,796
60"	240"	08VOFR60240VSF	30,840	33,412	3,553	4,878	8,361	3,796

Order Code	Specification Information	Refer To Accessories Section	Pricing Tiers
Example: 08VOFR60120VSFM-T003-PM01-MC01-GM2-MC01-UCO	To order please specify pattern number including:	Please refer to Accessories section, page 211 for power details.	Please refer to Materials and Finish page 7 for specification details.
08 Highline Collection	1. Top finish	Grommet options available in these finishes:	T1 and T2 pricing includes powder coated base finish.
VOF Vector Base	2. Trim Finish (only applies if trim type is metal or leather)	Powder coated	There is an upcharge for plated base finishes as highlighted above.
R Rectangular	3. Base finish	Premium (Polished Chrome, Satin Nickel or Oil Rubbed Bronze)	For additional stone options and pricing please contact your sales representative."
60 Depth	4. Grommet option	Power Box Options	
120 Width	5. Grommet finish (only applies if grommets are selected)	Code: Description:	
V Veneer	6. Power box option	NP No Power	
SF Slab	7. Table-top power finish (only applies if table-top power is selected)	UCO Undermount	
M Metal Trim		ECO Table Top Lid	
T003 Top Finish	Trim Type	T1E Tabletop 1-Sided Lid	
PM01 Trim Finish	N = No trim	T2C Tabletop 2-Sided Lid	
MC01 Base Finish	M = Metal (available in Premium and Powder Coat finishes)	Must select Wire Management	
GM2 Grommet Opt.	L = Leather	Column and Finish:	
MC01 Grommet Finish		Powder coated	
UCO Undermount		Premium (Polished Chrome, Satin Nickel or Oil Rubbed Bronze)	

Rectangular Conference Tables

60" Deep Tops
1-Layer, Glass Tops

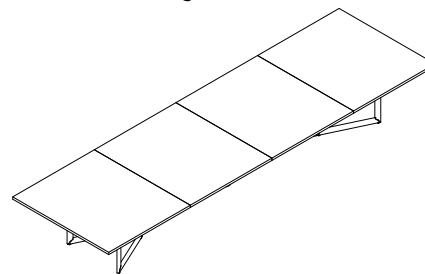

D	W	Pattern No.	GC__ Top	GE__ Top	PM__ Edge Upcharge	AU__ Edge Upcharge	PM__ Base Upcharge
60"	120"	08VOFR60120GF1	\$24,570	\$25,735	\$802	\$2,885	\$2,290
60"	132"	08VOFR60132GF1	27,038	28,321	884	3,078	2,290
60"	144"	08VOFR60144GF1	29,507	30,906	933	3,270	2,290
60"	156"	08VOFR60156GF1	31,976	33,491	981	4,368	2,290
60"	168"	08VOFR60168GF1	30,668	36,076	1,030	3,654	2,290
60"	180"	08VOFR60180GF1	36,912	38,660	1,079	3,847	2,290
60"	192"	08VOFR60192GF1	39,768	41,633	1,128	4,040	3,796
60"	204"	08VOFR60204GF1	41,280	43,261	1,178	4,231	3,796
60"	216"	08VOFR60216GF1	42,792	44,890	1,227	4,424	3,796
60"	228"	08VOFR60228GF1	44,303	46,518	1,276	4,616	3,796
60"	240"	08VOFR60240GF1	45,816	48,147	1,325	4,808	3,796

Order Code	Specification Information	Refer To Accessories Section	Pricing Tiers
Example: 08VOFR60120GF1M-GE01-PM01-MC01-GM2-MC01-UCO	To order please specify pattern number including:	Please refer to Accessories section, page 211 for power details.	Please refer to Materials and Finish page 7 for specification details.
08 Highline Collection	1. Top finish	Grommet options available in these finishes:	T1 and T2 pricing includes powder coated base finish.
VOF Vector Base	2. Trim Finish (only applies if trim type is metal or leather)	Powder coated	There is an upcharge for plated base finishes as highlighted above.
R Rectangular	3. Base finish	Premium (Polished Chrome, Satin Nickel or Oil Rubbed Bronze)	For additional stone options and pricing please contact your sales representative."
60 Depth	4. Grommet option	Power Box Options	
120 Width	5. Grommet finish (only applies if grommets are selected)	Code: Description:	
G Glass	6. Power box option	NP No Power	
F1 1 Layer-Flat w/ Trim	7. Table-top power finish (only applies if table-top power is selected)	UCO Undermount	
M Metal Trim		ECO Table Top Lid	
GE01 Top Finish	Trim Type	T1E Tabletop 1-Sided Lid	
PM01 Trim Finish	N = No trim	T2C Tabletop 2-Sided Lid	
MC01 Base Finish	M = Metal (available in Premium and Powder Coat finishes)	Must select Wire Management	
GM2 Grommet Opt.	L = Leather	Column and Finish:	
MC01 Grommet Finish		Powder coated	
UCO Undermount		Premium (Polished Chrome, Satin Nickel or Oil Rubbed Bronze)	

Rectangular Conference Tables

60" Deep Tops
2-Layer, Glass Tops

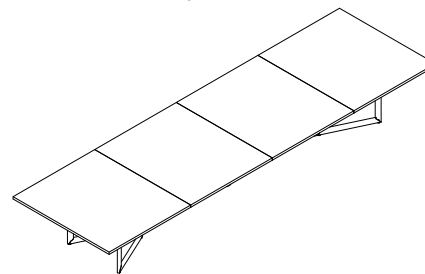

D	W	Pattern No.	GC__ Top	GE__ Top	T__ Lower Layer	HG__ Lower Layer	PM__ Edge Upcharge	AU__ Edge Upcharge	PM__ Base Upcharge
60"	120"	08VOFR60120GF2	\$26,586	\$27,751	\$807	\$888	\$802	\$2,885	\$2,290
60"	132"	08VOFR60132GF2	28,902	30,184	899	989	884	3,078	2,290
60"	144"	08VOFR60144GF2	31,219	32,617	955	1,051	933	3,270	2,290
60"	156"	08VOFR60156GF2	33,536	35,052	1,023	1,125	981	4,368	2,290
60"	168"	08VOFR60168GF2	32,077	37,485	1,078	1,186	1,030	3,654	2,290
60"	180"	08VOFR60180GF2	38,173	39,921	1,115	1,228	1,079	3,847	2,290
60"	192"	08VOFR60192GF2	41,289	43,153	1,214	1,337	1,128	4,040	3,796
60"	204"	08VOFR60204GF2	42,814	44,795	1,281	1,410	1,178	4,231	3,796
60"	216"	08VOFR60216GF2	44,338	46,436	1,313	1,445	1,227	4,424	3,796
60"	228"	08VOFR60228GF2	45,863	48,077	1,418	1,560	1,276	4,616	3,796
60"	240"	08VOFR60240GF2	47,385	49,716	1,485	1,635	1,325	4,808	3,796

Order Code	Specification Information	Refer To Accessories Section	Pricing Tiers
Example: 08VOFR60120GF2M-GE01-PM01-MC01-GM2-MC01-UCO	To order please specify pattern number including:	Please refer to Accessories section, page 211 for power details.	Please refer to Materials and Finish page 7 for specification details.
08 Highline Collection	1. Top finish	Grommet options available in these finishes:	T1 and T2 pricing includes powder coated base finish.
VOF Vector Base	2. Trim Finish (only applies if trim type is metal or leather)	Powder coated	There is an upcharge for plated base finishes as highlighted above.
R Rectangular	3. Base finish	Premium (Polished Chrome, Satin Nickel or Oil Rubbed Bronze)	For additional stone options and pricing please contact your sales representative."
60 Depth	4. Grommet option	Power Box Options	
120 Width	5. Grommet finish (only applies if grommets are selected)	Code: Description:	
G Glass	6. Power box option	NP No Power	
F2 2 Layer-Flat w/ Trim	7. Table-top power finish (only applies if table-top power is selected)	UCO Undermount	
M Metal Trim		ECO Table Top Lid	
GE01 Top Finish	Trim Type	T1E Tabletop 1-Sided Lid	
PM01 Trim Finish	N = No trim	T2C Tabletop 2-Sided Lid	
MC01 Base Finish	M = Metal (available in Premium and Powder Coat finishes)	Must select Wire Management	
GM2 Grommet Opt.	L = Leather	Column and Finish:	
MC01 Grommet Finish		Powder coated	
UCO Undermount		Premium (Polished Chrome, Satin Nickel or Oil Rubbed Bronze)	

Rectangular Conference Tables

60" Deep Tops
1-Layer, Corian Tops

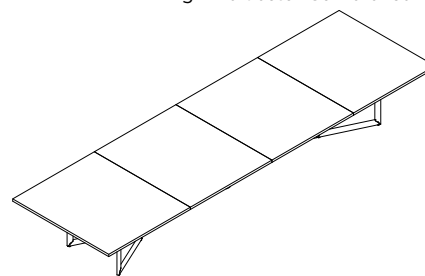

D	W	Pattern No.	CS01 Top	MC__ Edge Upcharge	PM__ Edge Upcharge	AU__ Edge Upcharge	PM__ Base Upcharge
60"	120"	08VOFR6012OCF1	\$23,851	\$2,295	\$3,097	\$5,180	\$2,181
60"	132"	08VOFR60132CF1	26,257	2,514	3,398	5,592	2,181
60"	144"	08VOFR60144CF1	28,662	2,735	3,668	6,005	2,181
60"	156"	08VOFR60156CF1	31,067	2,955	3,936	7,323	2,181
60"	168"	08VOFR60168CF1	33,473	3,176	4,206	6,830	2,181
60"	180"	08VOFR60180CF1	35,876	3,397	4,476	7,244	2,181
60"	192"	08VOFR60192CF1	38,655	3,616	4,744	7,656	2,181
60"	204"	08VOFR60204CF1	40,378	3,600	4,778	7,831	3,686
60"	216"	08VOFR60216CF1	42,103	3,583	4,810	8,007	3,686
60"	228"	08VOFR60228CF1	43,826	3,568	4,844	8,184	3,686
60"	240"	08VOFR6024OCF1	45,550	3,553	4,878	8,361	3,686

Order Code	Specification Information	Refer To Accessories Section	Pricing Tiers
Example: 08VOFR6012OCF1M-CS01-PM01-MC01-GM2-MC01-UCO	To order please specify pattern number including:	Please refer to Accessories section, page 211 for power details.	Please refer to Materials and Finish page 7 for specification details.
08 Highline Collection	1. Top finish	Grommet options available in these finishes:	T1 and T2 pricing includes powder coated base finish.
VOF Vector Base	2. Trim Finish (only applies if trim type is metal or leather)	Powder coated	There is an upcharge for plated base finishes as highlighted above.
R Rectangular	3. Base finish	Premum (Polished Chrome, Satin Nickel or Oil Rubbed Bronze)	For additional stone options and pricing please contact your sales representative."
60 Depth	4. Grommet option	Power Box Options	
120 Width	5. Grommet finish (only applies if grommets are selected)	Code: Description:	
C Corian	6. Power box option	NP No Power	
F1 1 Layer-Flat w/ Trim	7. Table-top power finish (only applies if table-top power is selected)	UCO Undermount	
M Metal Trim		ECO Table Top Lid	
CS01 Top Finish	Trim Type	T1E Tabletop 1-Sided Lid	
PM01 Trim Finish	N = No trim	T2C Tabletop 2-Sided Lid	
MC01 Base Finish	M = Metal (available in Premium and Powder Coat finishes)	Must select Wire Management	
GM2 Grommet Opt.	L = Leather	Column and Finish:	
MC01 Grommet Finish		Powder coated	
UCO Undermount		Premium (Polished Chrome, Satin Nickel or Oil Rubbed Bronze)	

Rectangular Conference Tables

60" Deep Tops
2-Layer, Corian Tops

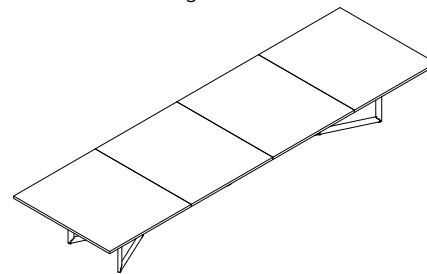

D	W	Pattern No.	CS01 Top	T__ Lower Layer	HG__ Lower Layer	PM__ Edge Upcharge	AU__ Edge Upcharge	PM__ Base Upcharge
60"	120"	08VOFR60120CF2	\$28,080	\$807	\$888	\$802	\$2,885	\$2,290
60"	132"	08VOFR60132CF2	30,559	899	989	884	3,078	2,290
60"	144"	08VOFR60144CF2	33,039	955	1,051	933	3,270	2,290
60"	156"	08VOFR60156CF2	35,520	1,023	1,125	981	4,368	2,290
60"	168"	08VOFR60168CF2	38,000	1,078	1,186	1,030	3,654	2,290
60"	180"	08VOFR60180CF2	40,483	1,115	1,228	1,079	3,847	2,290
60"	192"	08VOFR60192CF2	43,730	1,214	1,337	1,128	4,040	3,796
60"	204"	08VOFR60204CF2	45,450	1,281	1,410	1,178	4,231	3,796
60"	216"	08VOFR60216CF2	47,170	1,313	1,445	1,227	4,424	3,796
60"	228"	08VOFR60228CF2	48,890	1,418	1,560	1,276	4,616	3,796
60"	240"	08VOFR60240CF2	50,608	1,485	1,635	1,325	4,808	3,796

Order Code	Specification Information	Refer To Accessories Section	Pricing Tiers
Example: 08VOFR60120CF2M-CS01-PM01-MC01-GM2-MC01-UCO	To order please specify pattern number including:	Please refer to Accessories section, page 211 for power details.	Please refer to Materials and Finish page 7 for specification details.
08 Highline Collection	1. Top finish	Grommet options available in these finishes:	T1 and T2 pricing includes powder coated base finish.
VOF Vector Base	2. Trim Finish (only applies if trim type is metal or leather)	Powder coated	There is an upcharge for plated base finishes as highlighted above.
R Rectangular	3. Base finish	Premium (Polished Chrome, Satin Nickel or Oil Rubbed Bronze)	For additional stone options and pricing please contact your sales representative."
60 Depth	4. Grommet option	Power Box Options	
120 Width	5. Grommet finish (only applies if grommets are selected)	Code: Description:	
C Corian	6. Power box option	NP No Power	
F2 2 Layer-Flat w/ Trim	7. Table-top power finish (only applies if table-top power is selected)	UCO Undermount	
M Metal Trim		ECO Table Top Lid	
CS01 Top Finish	Trim Type	T1E Tabletop 1-Sided Lid	
PM01 Trim Finish	N = No trim	T2C Tabletop 2-Sided Lid	
MC01 Base Finish	M = Metal (available in Premium and Powder Coat finishes)	Must select Wire Management Column and Finish:	
GM2 Grommet Opt.	L = Leather	Powder coated	
MC01 Grommet Finish		Premium (Polished Chrome, Satin Nickel or Oil Rubbed Bronze)	
UCO Undermount			

Highline Vector Conference Tables

72" Deep Conference Tables

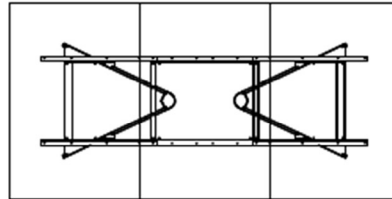
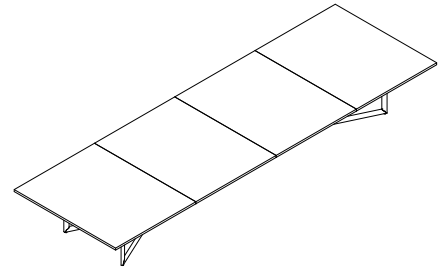

144L
SEATS 12

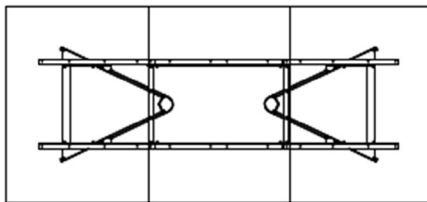

156L
SEATS 12

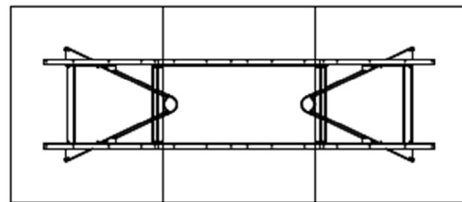

168L
SEATS 14

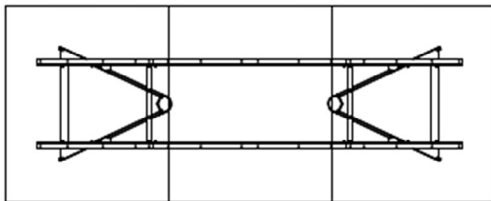

180L
SEATS 16

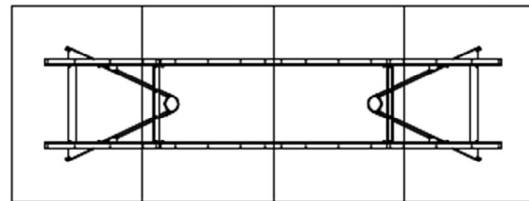

192L
SEATS 16

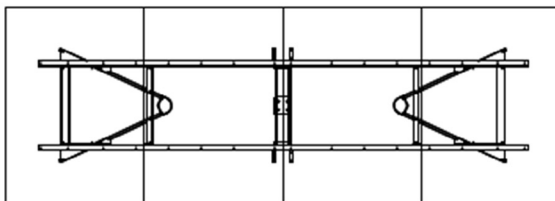

204L
SEATS 16

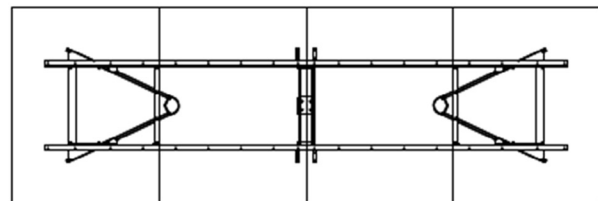

216L
SEATS 18

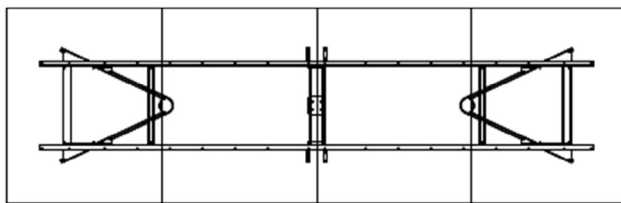

228L
SEATS 18

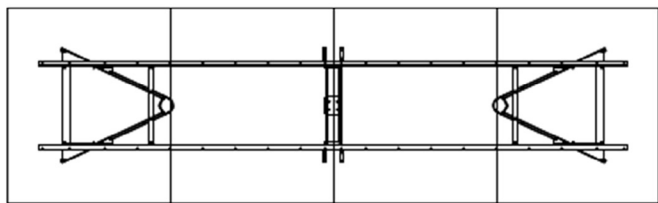

240L
SEATS 20

Highline Vector Conference Tables

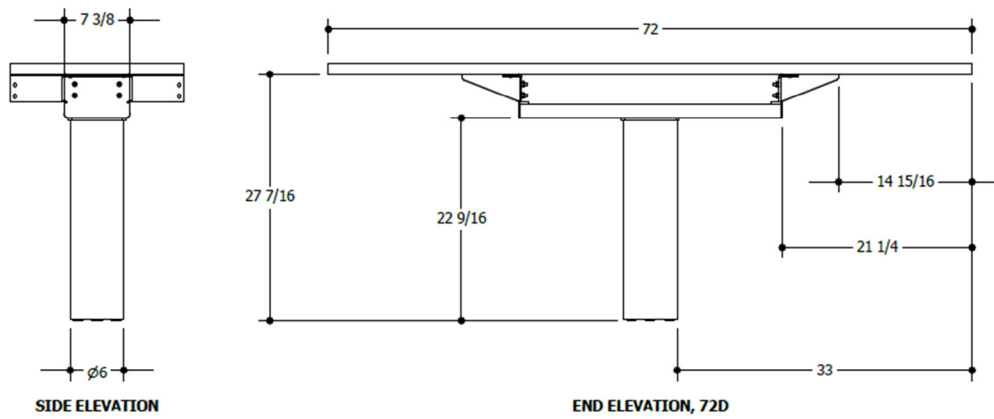
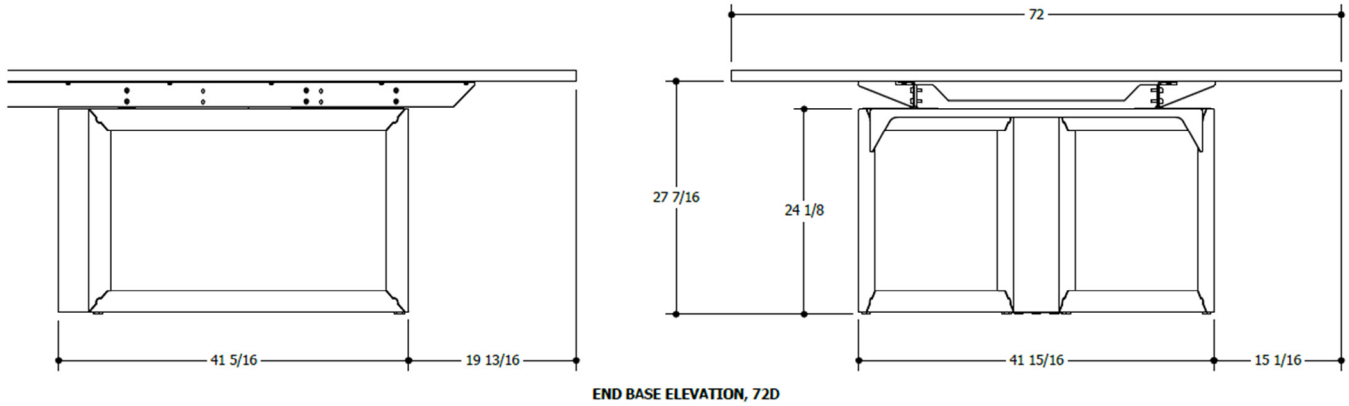
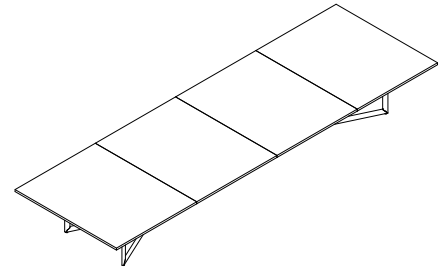

Rectangular Conference Tables

72" Deep Tops
1-Layer, Veneer Tops

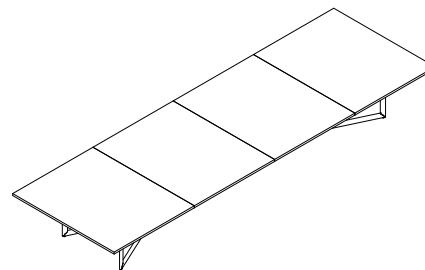

D	W	Pattern No.	T1__ Top	T2__ Top	MC__ Edge Upcharge	PM__ Edge Upcharge	AU__ Edge Upcharge	PM__ Base Upcharge
72"	144"	08VOFR72144VF1	\$23,723	\$25,575	\$4,223	\$5,204	\$3,462	\$2,507
72"	156"	08VOFR72156VF1	24,804	26,810	4,284	5,314	3,654	2,507
72"	168"	08VOFR72168VF1	25,885	28,046	4,346	5,425	3,847	2,507
72"	180"	08VOFR72180VF1	26,967	29,281	4,407	5,535	4,040	2,507
72"	192"	08VOFR72192VF1	28,049	30,519	4,469	5,647	4,231	2,507
72"	204"	08VOFR72204VF1	30,227	32,850	4,489	5,716	4,424	4,012
72"	216"	08VOFR72216VF1	31,308	34,085	4,478	5,754	4,616	4,012
72"	228"	08VOFR72228VF1	32,389	35,321	4,467	5,792	4,808	4,012
72"	240"	08VOFR72240VF1	33,471	36,557	4,455	5,828	5,001	4,012

Order Code	Specification Information	Refer To Accessories Section	Pricing Tiers
Example: 08VOFR72144VF1M-T003-PM01-MC01-GM2-MC01-UC0	To order please specify pattern number including:	Please refer to Accessories section, page 211 for power details.	Please refer to Materials and Finish page 7 for specification details.
08 Highline Collection	1. Top finish	Grommet options available in these finishes:	T1 and T2 pricing includes powder coated base finish.
VOF Vector Base	2. Trim Finish (only applies if trim type is metal or leather)	Powder coated	There is an upcharge for plated base finishes as highlighted above.
R Rectangular	3. Base finish	Premium (Polished Chrome, Satin Nickel or Oil Rubbed Bronze)	For additional stone options and pricing please contact your sales representative."
72 Depth	4. Grommet option	Power Box Options	
144 Width	5. Grommet finish (only applies if grommets are selected)	Code: Description:	
V Veneer	6. Power box option	NP No Power	
F1 1 Layer-Flat w/ Trim	7. Table-top power finish (only applies if table-top power is selected)	UC0 Undermount	
M Metal Trim		ECO Table Top Lid	
T003 Top Finish	Trim Type	T1E Tabletop 1-Sided Lid	
PM01 Trim Finish	N = No trim	T2C Tabletop 2-Sided Lid	
MC01 Base Finish	M = Metal (available in Premium and Powder Coat finishes)	Must select Wire Management Column and Finish:	
GM2 Grommet Opt.	L = Leather	Powder coated	
MC01 Grommet Finish		Premium (Polished Chrome, Satin Nickel or Oil Rubbed Bronze)	
UC0 Undermount			

Rectangular Conference Tables

72" Deep Tops
2-Layer, Veneer Tops

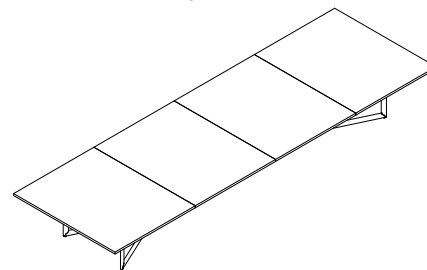

D	W	Pattern No.	T1__ Top	T2__ Top	T__ Lower Layer	HG__ Lower Layer	PM__ Edge Upcharge	AU__ Edge Upcharge	PM__ Base Upcharge
72"	144"	08VOFR72144VF2	\$28,758	\$30,610	\$984	\$1,083	\$981	\$3,462	\$2,507
72"	156"	08VOFR72156VF2	29,879	31,885	1,127	1,240	1,030	3,654	2,507
72"	168"	08VOFR72168VF2	30,999	33,160	1,214	1,337	1,079	3,847	2,507
72"	180"	08VOFR72180VF2	32,119	34,435	1,289	1,418	1,128	4,040	2,507
72"	192"	08VOFR72192VF2	33,238	35,707	1,361	1,498	1,178	4,231	2,507
72"	204"	08VOFR72204VF2	35,760	38,383	1,436	1,580	1,227	4,424	4,012
72"	216"	08VOFR72216VF2	36,853	39,631	1,510	1,660	1,276	4,616	4,012
72"	228"	08VOFR72228VF2	37,947	40,879	1,578	1,736	1,325	4,808	4,012
72"	240"	08VOFR72240VF2	39,040	42,126	1,657	1,825	1,373	5,001	4,012

Order Code	Specification Information	Refer To Accessories Section	Pricing Tiers
Example: 08VOFR72144VF2M-T003-PM01-MC01-GM2-MC01-UCO	To order please specify pattern number including:	Please refer to Accessories section, page 211 for power details.	Please refer to Materials and Finish page 7 for specification details.
08 Highline Collection	1. Top finish	Grommet options available in these finishes:	T1 and T2 pricing includes powder coated base finish.
VOF Vector Base	2. Trim Finish (only applies if trim type is metal or leather)	Powder coated	There is an upcharge for plated base finishes as highlighted above.
R Rectangular	3. Base finish	Premium (Polished Chrome, Satin Nickel or Oil Rubbed Bronze)	For additional stone options and pricing please contact your sales representative."
72 Depth	4. Grommet option	Power Box Options	
144 Width	5. Grommet finish (only applies if grommets are selected)	Code: Description:	
V Veneer	6. Power box option	NP No Power	
F2 2 Layer-Flat w/ Trim	7. Table-top power finish (only applies if table-top power is selected)	UCO Undermount	
M Metal Trim		ECO Table Top Lid	
T003 Top Finish	Trim Type	TIE Tabletop 1-Sided Lid	
PM01 Trim Finish	N = No trim	T2C Tabletop 2-Sided Lid	
MC01 Base Finish	M = Metal (available in Premium and Powder Coat finishes)	Must select Wire Management Column and Finish:	
GM2 Grommet Opt.	L = Leather	Powder coated	
MC01 Grommet Finish		Premium (Polished Chrome, Satin Nickel or Oil Rubbed Bronze)	
UCO Undermount			

Rectangular Conference Tables

72" Deep Tops
Slab Top, Veneer Tops

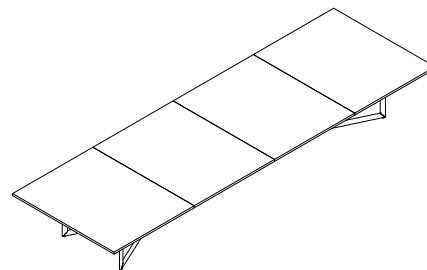

D	W	Pattern No.	T1__ Top	T2__ Top	MC__ Edge Upcharge	PM__ Edge Upcharge	AU__ Edge Upcharge	PM__ Base Upcharge
72"	144"	08VOFR72144VSF	\$24,535	\$26,388	\$4,223	\$5,204	\$7,685	\$2,507
72"	156"	08VOFR72156VSF	25,594	27,601	4,285	5,315	7,939	2,507
72"	168"	08VOFR72168VSF	26,654	28,814	4,345	5,424	8,192	2,507
72"	180"	08VOFR72180VSF	27,712	30,028	4,407	5,535	8,447	2,507
72"	192"	08VOFR72192VSF	28,769	31,239	4,469	5,647	8,700	2,507
72"	204"	08VOFR72204VSF	31,269	33,893	4,491	5,718	8,915	4,012
72"	216"	08VOFR72216VSF	32,375	35,152	4,478	5,754	9,094	4,012
72"	228"	08VOFR72228VSF	33,479	36,411	4,468	5,793	9,276	4,012
72"	240"	08VOFR72240VSF	34,584	37,670	4,456	5,829	9,457	4,012

Order Code	Specification Information	Refer To Accessories Section	Pricing Tiers
Example: 08VOFR72144VSFM-T003-PM01-MC01-GM2-MC01-UCO	To order please specify pattern number including:	Please refer to Accessories section, page 211 for power details.	Please refer to Materials and Finish page 7 for specification details.
08 Highline Collection	1. Top finish	Grommet options available in these finishes:	T1 and T2 pricing includes powder coated base finish.
VOF Vector Base	2. Trim Finish (only applies if trim type is metal or leather)	Powder coated	There is an upcharge for plated base finishes as highlighted above.
R Rectangular	3. Base finish	Premium (Polished Chrome, Satin Nickel or Oil Rubbed Bronze)	For additional stone options and pricing please contact your sales representative."
42 Depth	4. Grommet option	Power Box Options	
84 Width	5. Grommet finish (only applies if grommets are selected)	Code: Description:	
V Veneer	6. Power box option	NP No Power	
SF Slab	7. Table-top power finish (only applies if table-top power is selected)	UCO Undermount	
M Metal Trim		ECO Table Top Lid	
T003 Top Finish	Trim Type	T1E Tabletop 1-Sided Lid	
PM01 Trim Finish	N = No trim	T2C Tabletop 2-Sided Lid	
MC01 Base Finish	M = Metal (available in Premium and Powder Coat finishes)	Must select Wire Management Column and Finish:	
GM2 Grommet Opt.	L = Leather	Powder coated	
MC01 Grommet Finish		Premium (Polished Chrome, Satin Nickel or Oil Rubbed Bronze)	
UCO Undermount			

Rectangular Conference Tables

72" Deep Tops
1-Layer, Glass Tops

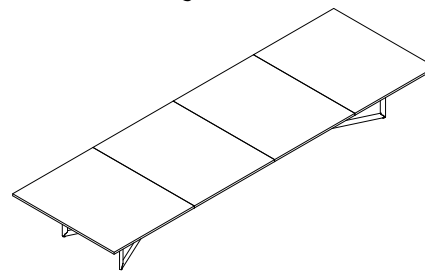

D	W	Pattern No.	GC__ Top	GE__ Top	PM__ Edge Upcharge	AU__ Edge Upcharge	PM__ Base Upcharge
72"	144"	08VOFR72144GF1	\$37,434	\$39,112	\$981	\$3,462	\$2,507
72"	156"	08VOFR72156GF1	39,317	41,135	1,030	3,654	2,507
72"	168"	08VOFR72168GF1	41,201	43,159	1,079	3,847	2,507
72"	180"	08VOFR72180GF1	43,084	45,181	1,128	4,040	2,507
72"	192"	08VOFR72192GF1	44,968	47,206	1,178	4,231	2,507
72"	204"	08VOFR72204GF1	47,952	50,330	1,227	4,424	4,012
72"	216"	08VOFR72216GF1	49,760	52,382	1,276	4,616	4,012
72"	228"	08VOFR72228GF1	51,567	54,225	1,325	4,808	4,012
72"	240"	08VOFR72240GF1	53,374	56,172	1,373	5,001	4,012

Order Code	Specification Information	Refer To Accessories Section	Pricing Tiers
Example: 08VOFR72144GF1M-GE01-PM01-MC01-GM2-MC01-UC0	To order please specify pattern number including:	Please refer to Accessories section, page 211 for power details.	Please refer to Materials and Finish page 7 for specification details.
08 Highline Collection	1. Top finish	Grommet options available in these finishes:	T1 and T2 pricing includes powder coated base finish.
VOF Vector Base	2. Trim Finish (only applies if trim type is metal or leather)	Powder coated	There is an upcharge for plated base finishes as highlighted above.
R Rectangular	3. Base finish	Premum (Polished Chrome, Satin Nickel or Oil Rubbed Bronze)	For additional stone options and pricing please contact your sales representative."
72 Depth	4. Grommet option	Power Box Options	
144 Width	5. Grommet finish (only applies if grommets are selected)	Code: Description:	
G Glass	6. Power box option	NP No Power	
F1 1 Layer-Flat w/ Trim	7. Table-top power finish (only applies if table-top power is selected)	UC0 Undermount	
M Metal Trim		ECO Table Top Lid	
GE01 Top Finish	Trim Type	T1E Tabletop 1-Sided Lid	
PM01 Trim Finish	N = No trim	T2C Tabletop 2-Sided Lid	
MC01 Base Finish	M = Metal (available in Premium and Powder Coat finishes)	Must select Wire Management	
GM2 Grommet Opt.	L = Leather	Column and Finish:	
MC01 Grommet Finish		Powder coated	
UC0 Undermount		Premium (Polished Chrome, Satin Nickel or Oil Rubbed Bronze)	

Rectangular Conference Tables

72" Deep Tops
2-Layer, Glass Tops

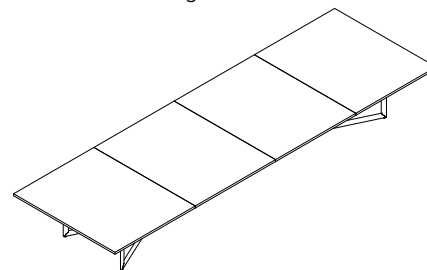

D	W	Pattern No.	GC__ Top	GE__ Top	T__ Lower Layer	HG__ Lower Layer	PM__ Edge Upcharge	AU__ Edge Upcharge	PM__ Base Upcharge
72"	144"	08VOFR72144GF2	\$38,281	\$39,959	\$984	\$1,083	\$981	\$3,462	\$2,507
72"	156"	08VOFR72156GF2	40,141	41,959	1,127	1,240	1,030	3,654	2,507
72"	168"	08VOFR72168GF2	42,001	43,959	1,214	1,337	1,079	3,847	2,507
72"	180"	08VOFR72180GF2	43,862	45,960	1,289	1,418	1,128	4,040	2,507
72"	192"	08VOFR72192GF2	45,719	47,956	1,361	1,498	1,178	4,231	2,507
72"	204"	08VOFR72204GF2	49,040	51,417	1,436	1,580	1,227	4,424	4,012
72"	216"	08VOFR72216GF2	50,871	53,494	1,510	1,660	1,276	4,616	4,012
72"	228"	08VOFR72228GF2	52,704	55,361	1,578	1,736	1,325	4,808	4,012
72"	240"	08VOFR72240GF2	54,535	57,333	1,657	1,825	1,373	5,001	4,012

Order Code	Specification Information	Refer To Accessories Section	Pricing Tiers
Example: 08VOFR72144GF2M-GE01-PM01-MC01-GM2-MC01-UCO	To order please specify pattern number including:	Please refer to Accessories section, page 211 for power details.	Please refer to Materials and Finish page 7 for specification details.
08 Highline Collection	1. Top finish	Grommet options available in these finishes:	T1 and T2 pricing includes powder coated base finish.
VOF Vector Base	2. Trim Finish (only applies if trim type is metal or leather)	Powder coated	There is an upcharge for plated base finishes as highlighted above.
R Rectangular	3. Base finish	Premium (Polished Chrome, Satin Nickel or Oil Rubbed Bronze)	For additional stone options and pricing please contact your sales representative."
72 Depth	4. Grommet option	Power Box Options	
144 Width	5. Grommet finish (only applies if grommets are selected)	Code: Description:	
G Glass	6. Power box option	NP No Power	
F2 2 Layer-Flat w/ Trim	7. Table-top power finish (only applies if table-top power is selected)	UCO Undermount	
M Metal Trim		ECO Table Top Lid	
GE01 Top Finish	Trim Type	T1E Tabletop 1-Sided Lid	
PM01 Trim Finish	N = No trim	T2C Tabletop 2-Sided Lid	
MC01 Base Finish	M = Metal (available in Premium and Powder Coat finishes)	Must select Wire Management Column and Finish:	
GM2 Grommet Opt.	L = Leather	Powder coated	
MC01 Grommet Finish		Premium (Polished Chrome, Satin Nickel or Oil Rubbed Bronze)	
UCO Undermount			

Rectangular Conference Tables

72" Deep Tops
1-Layer, Corian Tops

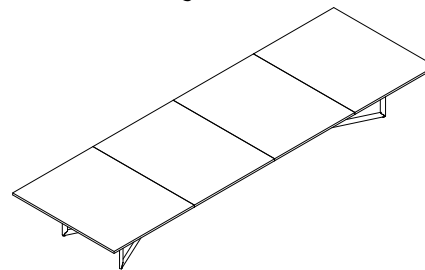

D	W	Pattern No.	CS01 Top	MC__ Edge Upcharge	PM__ Edge Upcharge	AU__ Edge Upcharge	PM__ Base Upcharge
72"	144"	08VOFR72144CF1	\$35,397	\$4,223	\$5,204	\$7,685	\$2,507
72"	156"	08VOFR72156CF1	37,452	4,283	5,313	7,937	2,507
72"	168"	08VOFR72168CF1	39,505	4,346	5,425	8,193	2,507
72"	180"	08VOFR72180CF1	41,559	4,407	5,535	8,447	2,507
72"	192"	08VOFR72192CF1	43,615	4,469	5,647	8,700	2,507
72"	204"	08VOFR72204CF1	46,765	4,490	5,717	8,914	4,012
72"	216"	08VOFR72216CF1	48,820	4,478	5,754	9,094	4,012
72"	228"	08VOFR72228CF1	50,874	4,467	5,792	9,275	4,012
72"	240"	08VOFR72240CF1	53,040	4,455	5,828	9,456	4,012

Order Code	Specification Information	Refer To Accessories Section	Pricing Tiers
Example: 08VOFR72144CF1M-CS01-PM01-MC01-GM2-MC01-UCO	To order please specify pattern number including:	Please refer to Accessories section, page 211 for power details.	Please refer to Materials and Finish page 7 for specification details.
08 Highline Collection	1. Top finish	Grommet options available in these finishes:	T1 and T2 pricing includes powder coated base finish.
VOF Vector Base	2. Trim Finish (only applies if trim type is metal or leather)	Powder coated	There is an upcharge for plated base finishes as highlighted above.
R Rectangular	3. Base finish	Premium (Polished Chrome, Satin Nickel or Oil Rubbed Bronze)	For additional stone options and pricing please contact your sales representative."
72 Depth	4. Grommet option	Power Box Options	
144 Width	5. Grommet finish (only applies if grommets are selected)	Code: Description:	
C Corian	6. Power box option	NP No Power	
F1 1 Layer-Flat w/ Trim	7. Table-top power finish (only applies if table-top power is selected)	UCO Undermount	
M Metal Trim		ECO Table Top Lid	
CS01 Top Finish	Trim Type	T1E Tabletop 1-Sided Lid	
PM01 Trim Finish	N = No trim	T2C Tabletop 2-Sided Lid	
MC01 Base Finish	M = Metal (available in Premium and Powder Coat finishes)	Must select Wire Management Column and Finish:	
GM2 Grommet Opt.	L = Leather	Powder coated	
MC01 Grommet Finish		Premium (Polished Chrome, Satin Nickel or Oil Rubbed Bronze)	
UCO Undermount			

Rectangular Conference Tables

72" Deep Tops
2-Layer, Corian Tops

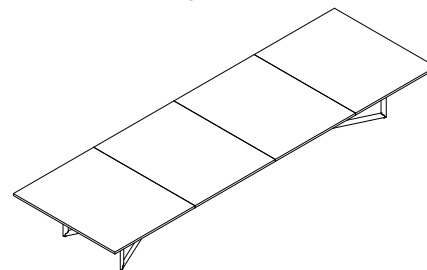

D	W	Pattern No.	CS01 Top	T__ Lower Layer	HG__ Lower Layer	PM__ Edge Upcharge	AU__ Edge Upcharge	PM__ Base Upcharge
72"	144"	08VOFR72144CF2	\$40,433	\$984	\$1,083	\$981	\$3,462	\$2,507
72"	156"	08VOFR72156CF2	42,525	1,127	1,240	1,030	3,654	2,507
72"	168"	08VOFR72168CF2	44,619	1,214	1,337	1,079	3,847	2,507
72"	180"	08VOFR72180CF2	46,713	1,289	1,418	1,128	4,040	2,507
72"	192"	08VOFR72192CF2	48,804	1,361	1,498	1,178	4,231	2,507
72"	204"	08VOFR72204CF2	52,298	1,436	1,580	1,227	4,424	4,012
72"	216"	08VOFR72216CF2	54,365	1,510	1,660	1,276	4,616	4,012
72"	228"	08VOFR72228CF2	56,431	1,578	1,736	1,325	4,808	4,012
72"	240"	08VOFR72240CF2	58,609	1,657	1,825	1,373	5,001	4,012

Order Code	Specification Information	Refer To Accessories Section	Pricing Tiers
Example: 08VOFR72144CF2M-CS01-PM01-MC01-GM2-MC01-UCO	To order please specify pattern number including:	Please refer to Accessories section, page 211 for power details.	Please refer to Materials and Finish page 7 for specification details.
08 Highline Collection	1. Top finish	Grommet options available in these finishes:	T1 and T2 pricing includes powder coated base finish.
VOF Vector Base	2. Trim Finish (only applies if trim type is metal or leather)	Powder coated	There is an upcharge for plated base finishes as highlighted above.
R Rectangular	3. Base finish	Premium (Polished Chrome, Satin Nickel or Oil Rubbed Bronze)	For additional stone options and pricing please contact your sales representative."
72 Depth	4. Grommet option	Power Box Options	
144 Width	5. Grommet finish (only applies if grommets are selected)	Code: Description:	
C Corian	6. Power box option	NP No Power	
F2 2 Layer-Flat w/ Trim	7. Table-top power finish (only applies if table-top power is selected)	UCO Undermount	
M Metal Trim		ECO Table Top Lid	
CS01 Top Finish	Trim Type	T1E Tabletop 1-Sided Lid	
PM01 Trim Finish	N = No trim	T2C Tabletop 2-Sided Lid	
MC01 Base Finish	M = Metal (available in Premium and Powder Coat finishes)	Must select Wire Management	
GM2 Grommet Opt.	L = Leather	Column and Finish:	
MC01 Grommet Finish		Powder coated	
UCO Undermount		Premium (Polished Chrome, Satin Nickel or Oil Rubbed Bronze)	

Accessories

Power & Connectivity
Undermount Power
For All Conference & Meeting Tables

Pattern No.	Description	LIST
UC0H	Undermount Hardwire QTY 1	\$1,692
UC0P	Undermount Plug In QTY 1	\$1,692
UC0A	Undermount Linkable Hardwire QTY 1	\$1,692
UC0B	Undermount Linkable Plug In QTY 1	\$1,692

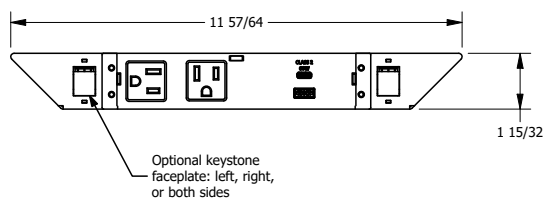
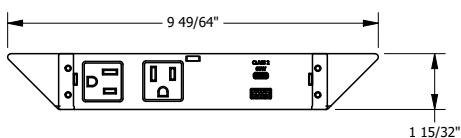
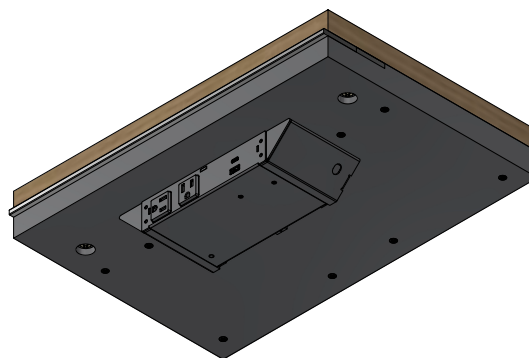
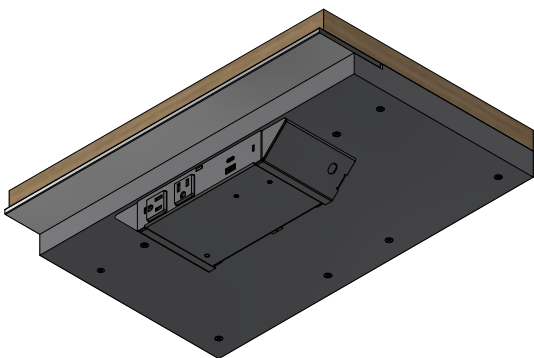
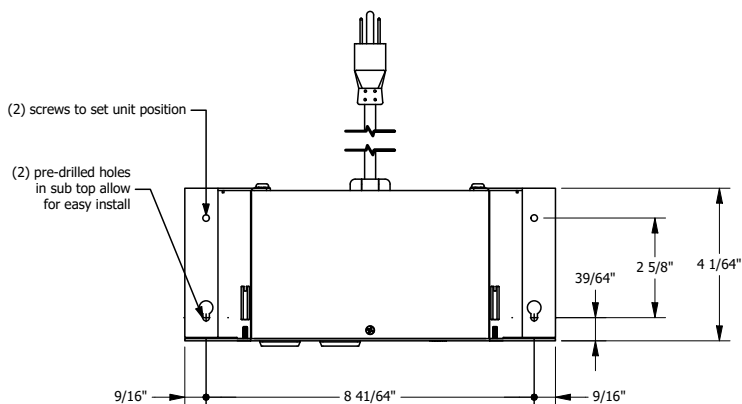
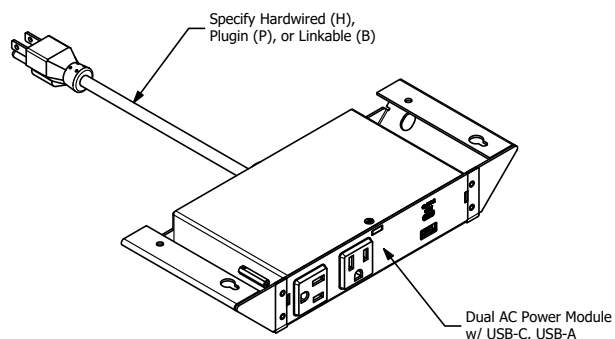

- Interior: Black powder coat
- Standard with Dual AC Power Module w/ USB-c, USB-A - specify hardwired (H), plugin (P), or linkable (B), and 2 blank end faces. (as shown above)
- For additional connectivity, please contact sale rep.

Shown above as a custom solution with (2) keystone cutouts

Power & Connectivity

Edgemount Power

For Highline Conference & Meeting Tables
and Highline Vector 1-Layer Tops

Pattern No.	Description	LIST
ECOH	Edgemount Hardwire QTY 1	\$1,541
ECOP	Edgemount Plug In QTY 1	\$1,541
ECOA	Edgemount Linkable Hardwire QTY 1	\$1,541
ECOB	Edgemount Linkable Plug In QTY 1	\$1,541

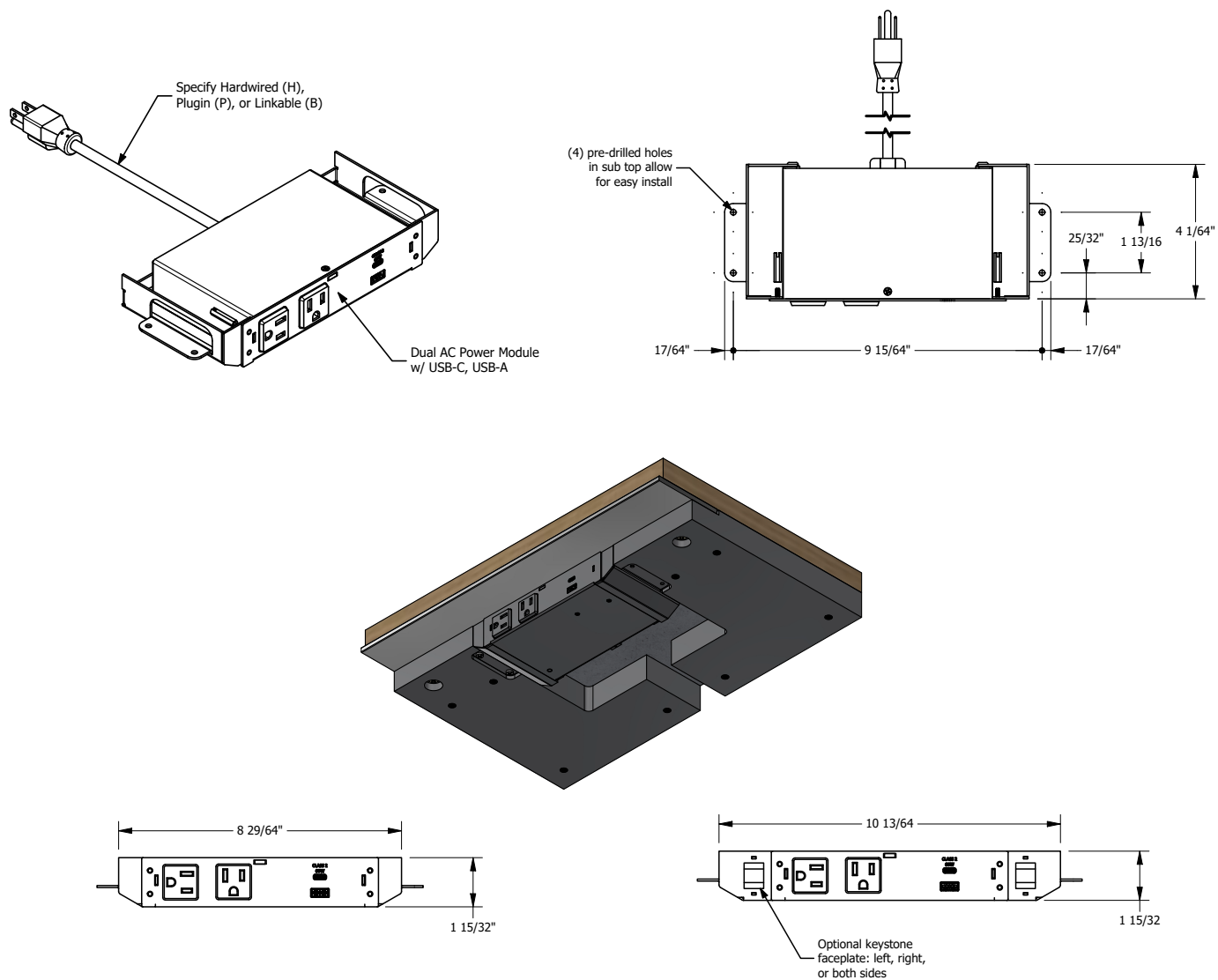

- Interior: Black powder coat
- Standard with Dual AC Power Module w/ USB-c, USB-A - specify hardwired (H), plugin (P), or linkable (B), and 2 blank end faces. (as shown above)
- For additional connectivity, please contact sale rep.

Shown above as a custom solution with (2) keystone cutouts

Power & Connectivity

Table Top Power Box

For Highline and Highline Fifty

Conference Tables

Pattern No.	Description	LIST
T1EH	Table Top Metal/Wood Lid Hardwire QTY 1	\$3,100
T1EP	Table Top Metal/Wood Lid Plug In QTY 1	\$3,100
T1EA	Table Top Metal/Wood Lid Linkable Hardwire QTY 1	\$3,100
T1EB	Table Top Metal/Wood Lid Linkable Plug In QTY 1	\$3,100

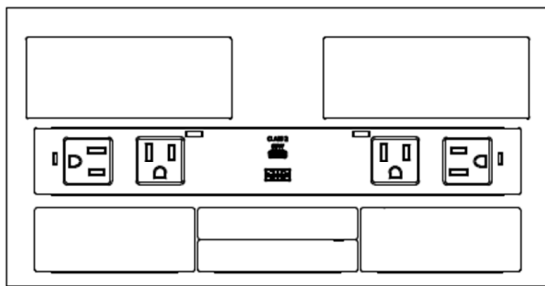
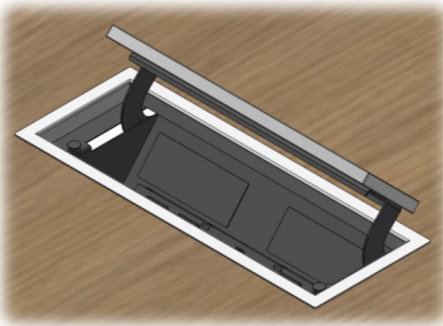
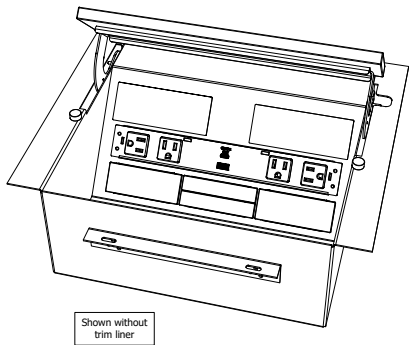

Single-Sided Conference Table Topmount

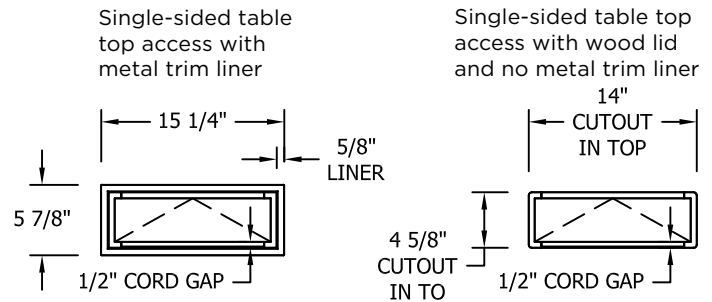

- Interior: Black powder coat metallic finish (MC12)
- Used in all conference tables
- Provided with:
 - (1) Quad AC power module w/ USB-C, USB-A - specify hardwired (H), plugin (P), or linkable (B),
 - (2) single and (2) double space blank plates
 - (2) retractor cutouts with blanks - 1, 2, or 3 knockout plates available
- For additional connectivity, replace double and single space blanks with single or double space AAP plates as desired.
- Designed to accommodate Extron Series 2 retractors.
- For more information contact customer service.

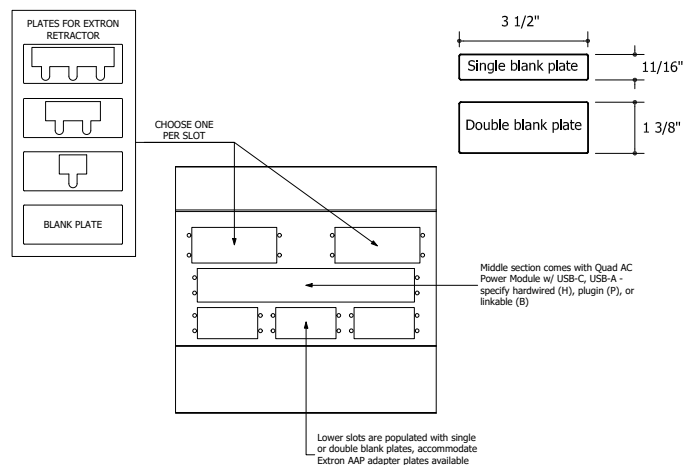

Power & Connectivity

Power Drawer

For Highline Fifty Conference and Meeting Tables
and Highline Vector 2-Layer Tops

Pattern No.	Description	LIST
DC0H	Power Drawer Hardwire QTY 1	\$2,591
DC0P	Power Drawer Plug In QTY 1	\$2,591
DC0A	Power Drawer Linkable Hardwire QTY 1	\$2,591
DC0B	Power Drawer Linkable Plug In QTY 1	\$2,591

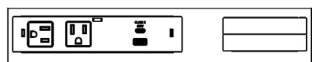
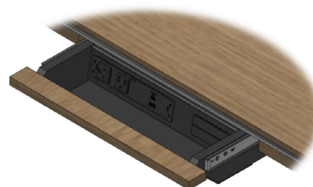
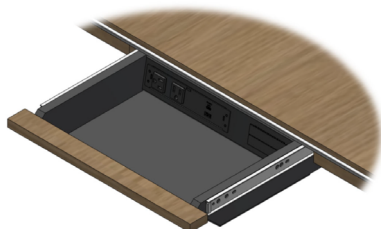
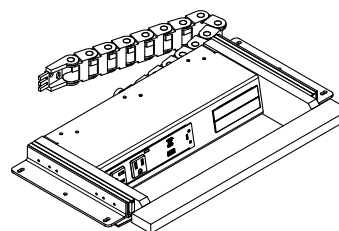
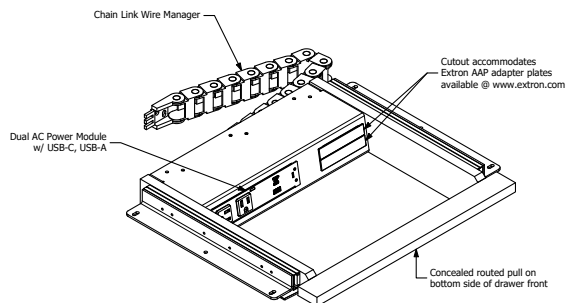

Large Power Drawer



Small Power Drawer

Large Drawer

- 6 1/2" deep x 12 3/4" wide flat storage with 2 1/2" interior height
- 3/8" gap above drawer for cord exit
- Concealed routed finger pull under front
- Used at table ends
- Used along the length of 60" / 72" deep tables
- Interior drawer finish: Black powder coat metallic (MC12)
- Drawer front matches lower layer finish
- Provided with 1 AC power module - specify hardwired (HW), plug in (PI), or linkable (LK), and 2 single space blank plates

Small Drawer

- 1 7/8" deep x 12 3/4" wide flat storage with 2 1/2" interior height
- 3/8" gap above drawer for cord exit
- Concealed routed finger pull under front
- Used along the length of 48" / 54" deep tables
- Interior drawer finish: Black powder coat metallic (MC12)
- Drawer front matches lower layer finish
- Provided with 1 AC power module - specify hardwired (HW), plug in (PI), or linkable (LK), and 2 single space blank plates

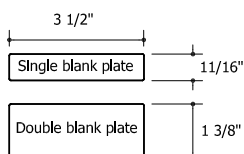

Power & Connectivity
Table Top Power Box
For Meeting Tables

Pattern No.	Description	LIST
T1CH	Meeting Table Top Metal/Wood Lid Hardwire QTY 1	\$2,739
T1CP	Meeting Table Top Metal/Wood Lid Plug In QTY 1	\$2,739
T1CA	Meeting Table Top Metal/Wood Lid Linkable Hardwire QTY 1	\$2,739
T1CB	Meeting Table Top Metal/Wood Lid Linkable Plug In QTY 1	\$2,739

Double-sided table top access with metal trim liner

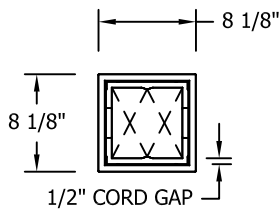

Double-sided table top access with wood lid and no metal trim liner

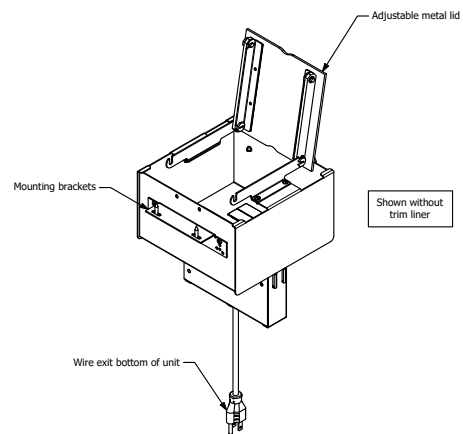
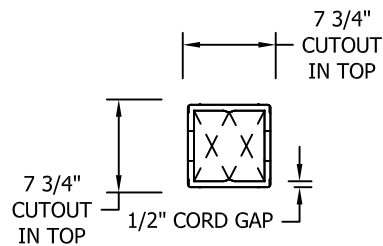

For Meeting Tables

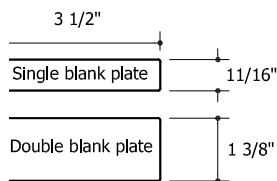
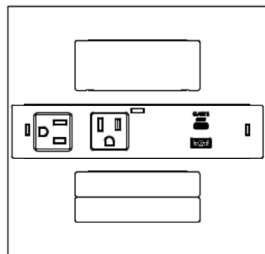
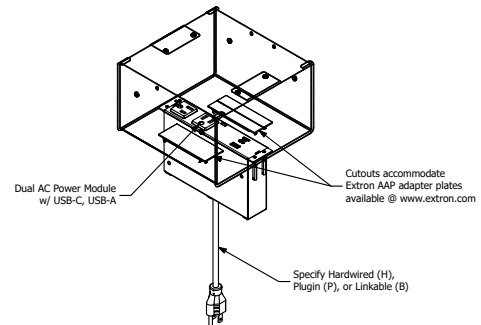
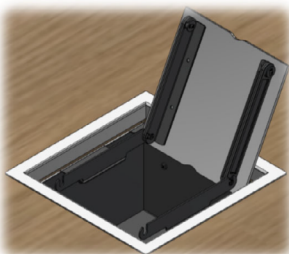

Double-Sided Meeting Table Topmount

- Provided with:
 - (1) Dual AC power module w/ USB-C, USB-A - specify hardwired (H), plugin (P), or linkable (B),
 - (2) single and (1) double space blank plates
- For additional connectivity, replace single and double space blanks with single or double space AAP plates as desired.
- Designed to accommodate Extron Series 2 retractors.
- For more information contact customer service.

Power & Connectivity

Dual Flip Table Top

For All Conference Tables

Pattern No.	Description	LIST
T2CH	Table Top Metal/Wood Lid Hardwire QTY 1	\$3,629
T2CP	Table Top Metal/Wood Lid Plug In QTY 1	\$3,629
T2CA	Table Top Metal/Wood Lid Linkable Hardwire QTY 1	\$3,629
T2CB	Table Top Metal/Wood Lid Linkable Plug In QTY 1	\$3,629

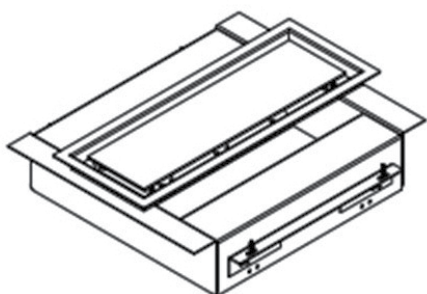

DOUBLE-HINGED TOPMOUNT

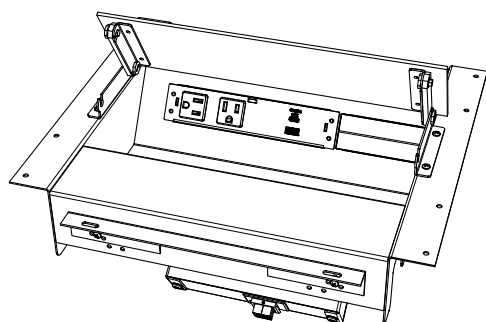
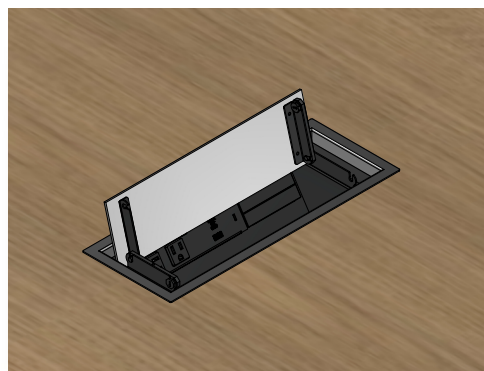

Shown without trim liner

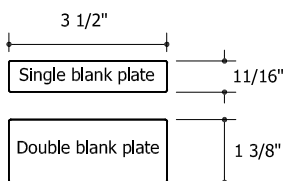

- Provided with:
 - (2) Dual AC power modules w/ USB-C, USB-A - specify hardwired (H), plugin (P), or linkable (B),
 - (4) single space blank plates
- For additional connectivity, replace single and double space blanks with single or double space AAP plates as desired.
- For more information contact customer service.

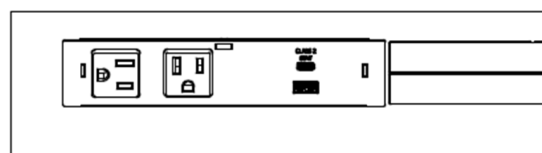
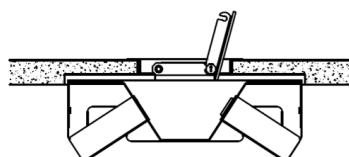

Double-Sided Conference Table Topmount
(Both Sides)

Single-sided table top access with metal trim liner

Single-sided table top access with wood lid and no metal trim liner

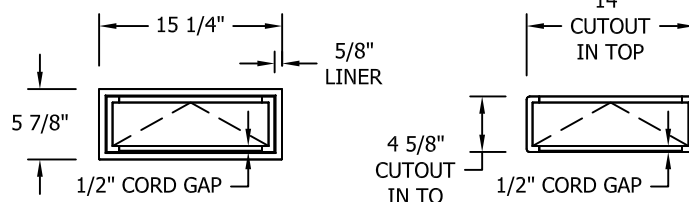

Wire Management Column

Necessary on all HL Conference tables

Grommet and Microphone Holes

Wire Management Column

Pattern No.	MC__	PM01/PM02	PM03
02WMC6X6	\$585	\$1,556	\$2,194
02WMC10X10	\$1,064	\$1,649	\$3,736

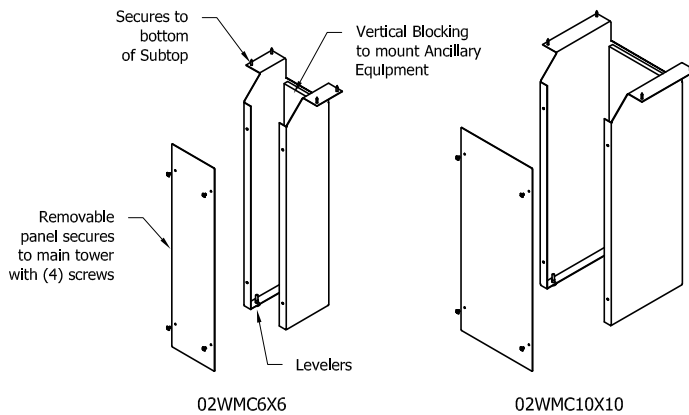

Wire Management Column

- Ordered separately but required with all power options for Highline Conference Tables
- Location is flexible but placement on table centerline is recommended

02WMC6X6 6" x 6" with clear inside of 4" x 5"
02WMC10X10 10" x 10" with clear inside of 8" x 9"

Grommet and Microphone Holes

Pattern No.	Description	LIST
MA__	Microphone Hole (factory cut)	\$386
GM__	2" Grommet (factory cut, lid, & liner)	\$508



Note: microphone hole cutout to match customer supplied specification.

